

ITEM NO.	PART NUMBER	DESCRIPTION	QTY.	NOTES
1	TLY-13	NEMA 5-15P	1	black overmold
2	TLY-18	C13	1	black overmold
3	30-00248	Wire, 3C, 18 AWG, UL SJT, 300V, 105°C, 7.75 mm, VW-1, PVC	1	

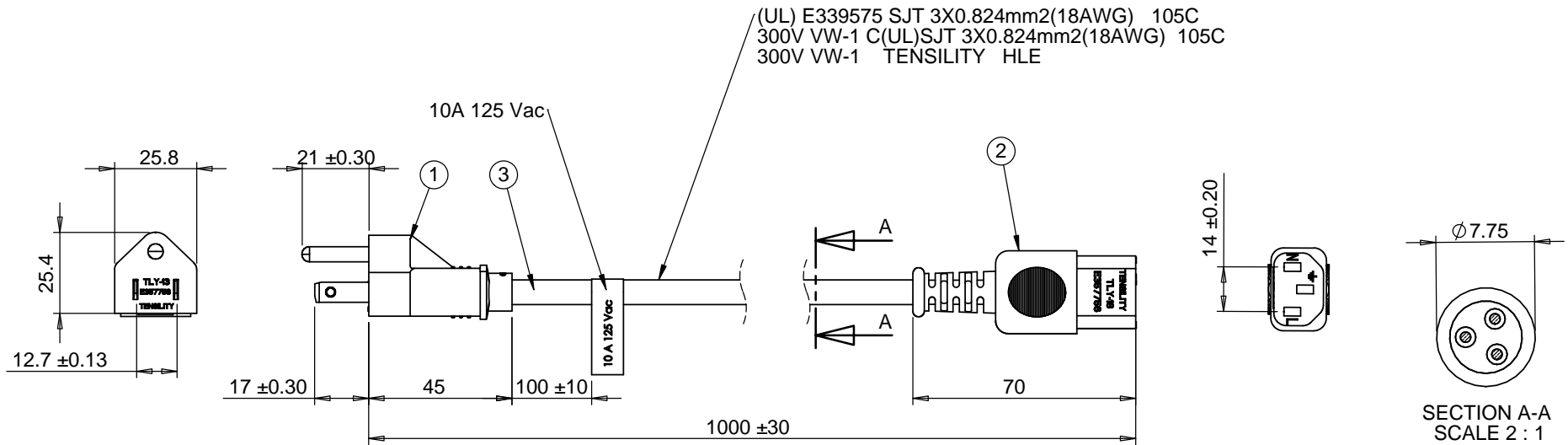

Revision	Date	Description	Notes		<h1>TENSILITY</h1> <p>20802 Sockeye Place #130 Bend, OR 97701 USA tel 541.323.3228 fax 541.323.4202 800 877.670.7118 www.tensility.com</p>				
A	12/19/2012	Initial release	Rated for 10 A at 125 Vac RoHS, REACH and Dodd-Frank conflict materials compliant Function test: no open, no reversed polarity, no short circuit, no INT						
			DIMENSIONS ARE IN MILLIMETERS TOLERANCES: X: ± 0.5 mm X.X: ± 0.3 mm X.XX: ± 0.05 mm	DESCRIPTION: Ac cord, 1000 mm, U.S, NEMA 5-15P plug, TLY-13 to C13, TLY-18, 18 AWG, SJT wire, 30-00248	SIZE A	Part number 11-00024	SCALE:1:2	WEIGHT:	SHEET 1 OF 1