

ITEM NO.	PART NUMBER	DESCRIPTION	QTY.	NOTES
1	TLY-1P	NEMA 1-15P	1	white overmold
2	TLY-53	C7, polarized	1	white overmold
3	30-00247	Wire, 2C, 18 AWG, UL SPT-2, 300V, 105C, 7.05 mm, VW-1, PVC, white	1	

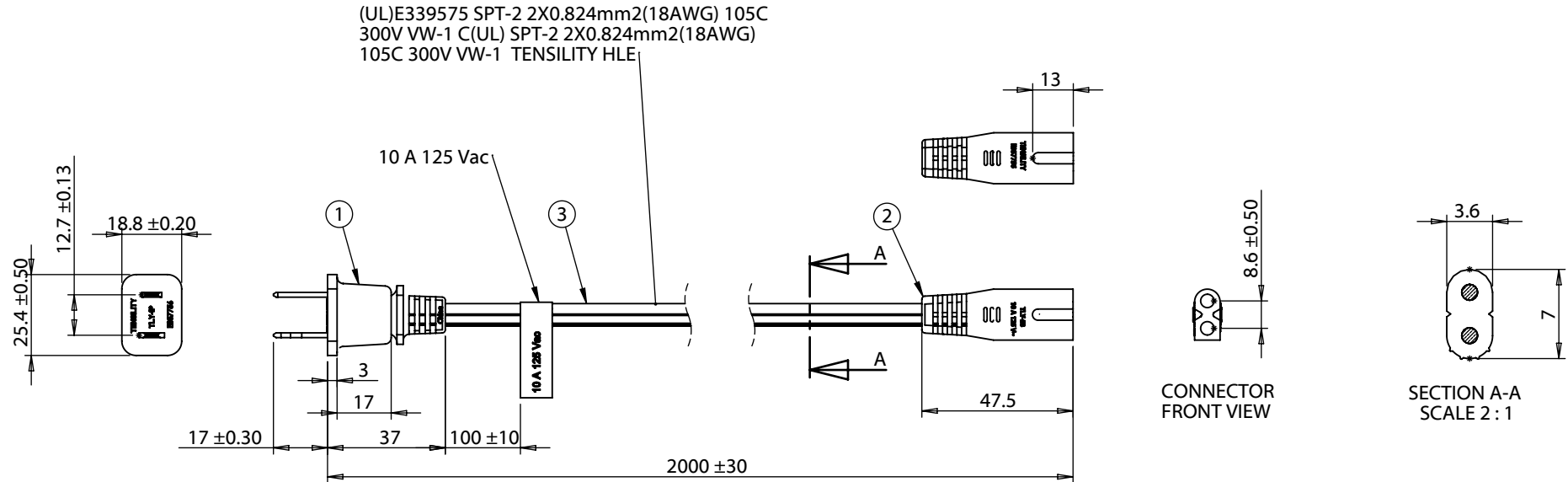

REVISION	DATE	DESCRIPTION	NOTES	TENSILITY		
A	2/5/2013	Initial release	Rated for 10 A at 125 Vac RoHS, REACH and Dodd-Frank conflict materials compliant Function test: no open, no reversed polarity, no short circuit, no INT	20802 Sockeye Place #130 Bend, OR 97701 USA tel 541.323.3228 fax 541.323.4202 800 877.670.7118 www.tensility.com		
			DIMENSIONS ARE IN MILLIMETERS	SIZE	PART NUMBER	
			TOLERANCES: X: ± 0.5 mm X.X: ± 0.3 mm X.XX: ± 0.05 mm	A	11-00026	
			DESCRIPTION: Ac cord, 2000 mm, U.S, NEMA 1-15P plug, TLY-1P to C7, TLY-53, 18 AWG, SPT-2 wire, 30-00247, white	SCALE: 1:2	WEIGHT:	SHEET 1 OF 1