

Specification

SAWX4A0X (AX4240-0X)

SSC		Customer
Drawn	Approval	Approval

Contents

- 1. Description**
- 2. Part number**
- 3. Mechanical dimensions**
- 4. Optical and thermal characteristics**
- 5. Color spectrum, Ta=25°C**
- 6. Radiant pattern, Ta=25°C**
- 7. I-V characteristics, Ta=25°C**
- 8. Relative Flux vs. Forward voltage**
- 9. Relative Flux vs. Junction temperature**
- 10. Forward Current vs. Junction temperature**
- 11. Acriche Binning structure graphical representation**
- 12. Operating instructions**
- 13. Emitter Reel Packaging**
- 14. Solder profile**
- 15. Precautions for use**
- 16. Handling of silicone resin for LEDs**

SAWX4A0X

Description

The Acriche series of LEDs are designed for AC operation and high flux output applications. Acriche LEDs are an environmentally friendly semiconductor lighting source that can be directly connected to an AC power source without any DC conversion required.

Acriche's thermal management performance exceeds other power LED solutions by incorporating state-of-the-art SMD design and use of specialized thermal emission material. Acriche is an ideal light source for general purpose illumination applications



Features

- Connect directly to AC power
- Power Saving
- Long Life
- Simplified B.O.M
- Small design footprint
- Low thermal resistance
- SMT solderability
- Lead Free and RoHS compliant

Applications

- Architectural lighting
- Task lighting
- Decorative and Pathway lighting
- White goods and gaming
- Spot lighting





* product specification may change without notice

Part number of SAWX4A0X

1. Part Number form : SA X₁ X₂ X₃ X₄ X₅ X₆ - X₇ X₈ X₉ X₁₀ X₁₁

X₁X₂	Color	W0	Cool white
		W8	Warm white
X₃	Acriche series	4	A4 series
X₄	Voltage	A	50 / 55V,RMS
X₅	PCB type	0	Emitter
X₆	-	X	Internal code
X₇X₈	Brightness bin	-	-
X₉X₁₀	Color bin	-	-
X₁₁	VF bin	-	-

2. Sticker Diagram on Reel & Aluminum Vinyl Bag

PART NO. : S A X₁ X₂ X₃ X₄ X₅ X₆

 QUANTITY : ###

 LOT NUMBER : #####

 BIN CODE : X₇X₈ X₉ X₁₀ X₁₁

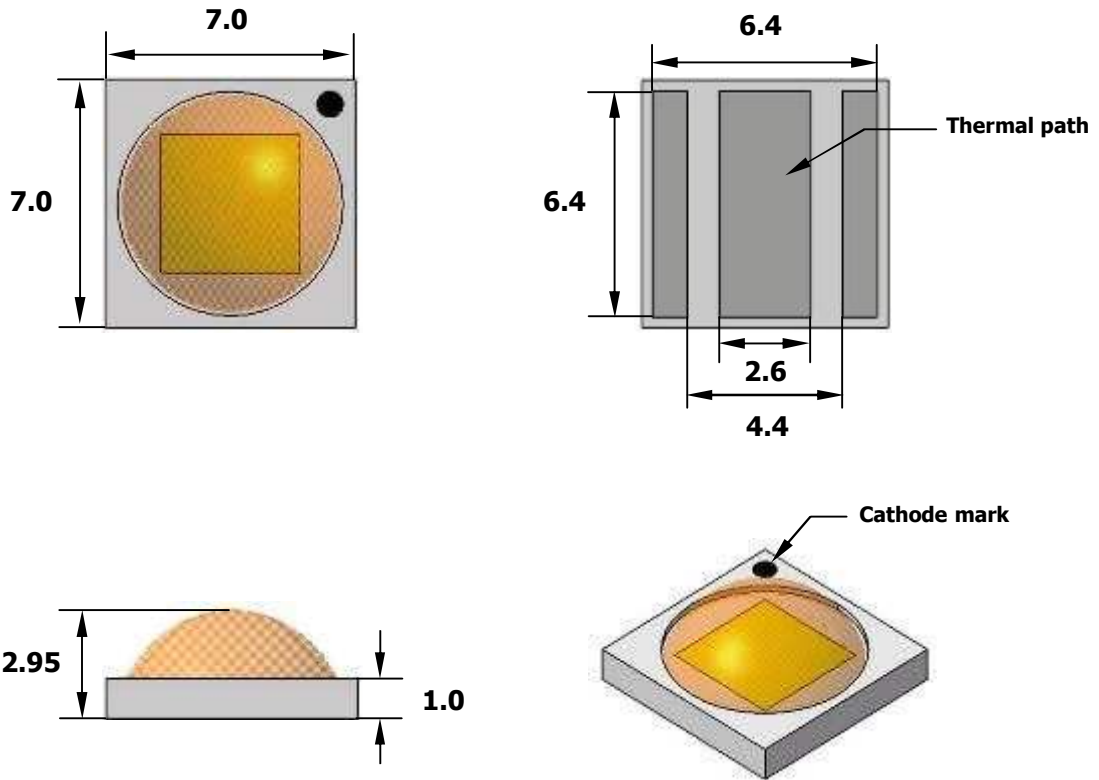

* For more information about binning and labeling, refer to the Application Note -1

Mechanical dimensions

1. Outline dimensions



2. Recommended PCB solder pad

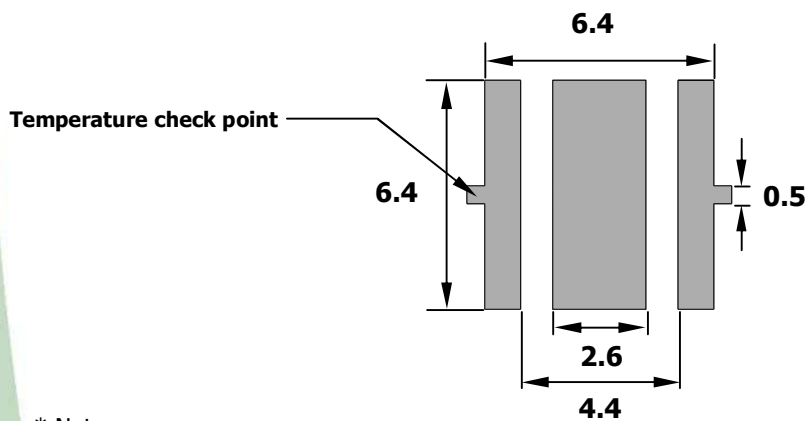

* Notes :

- [1] All dimensions are in millimeters. (Tolerance : ± 0.2)
- [2] Scale : none
- [3] The appearance and specifications of the product may be changed for improvement without notice
- [4] Electrically neutral thermal path
- [5] Do not design solder-pad larger than recommended size.
- [6] Excess solder paste may form solder ball and create electrical short between internal pads.

Rev. 07

September 2012

www.seoulsemicon.com

서식번호 : SSC-QP-7-07-18 (Rev.00)

Optical and thermal characteristics

1. SAW04A0A (AW4240-01)

1-1 Electro-Optical characteristics at 55V[RMS] Ta=25°C

Parameter	Symbol	Value			Unit
		Min	Typ	Max	
Luminous Flux ^[1]	Φ_V ^[2]	-	90	-	lm
Illuminance ^[3]	Φ_I	-	-	-	lx
Correlated Color Temperature ^[4]	CCT	-	5600	-	K
CRI	R _a	65	70	-	-
Operating Current	I _{opt}	-	20	-	mA [RMS]
Power Dissipation	P _D	0.80			W
Operating Frequency	Freq	50/60			Hz
Thermal resistance	R _{th}	-			°C/W
View Angle	2 Θ 1/2	145			deg.

1-2 Absolute Maximum Ratings

Parameter	Symbol	Value	Unit
Operating Voltage	V _{opt} ^[5]	63	V [RMS]
Power Dissipation	P _D	-	W
Junction Temperature	T _j	125	°C
Operating Temperature	T _{opr}	-30 ~ +85	°C
Storage Temperature	T _{stg}	-40 ~ +120	°C
ESD Sensitivity	-	±6,000V HBM	-

* Notes :

- [1] Acrich series maintains a tolerance of ±10% on flux and power measurements and ± 2 on CRI measurements.
- [2] Φ_V is the total luminous flux output as measured with an integrating sphere.
- [3] Illuminance is measured at 50cm distance
- [4] Correlated Color Temperature is derived from the CIE 1931 Chromaticity diagram.
CCT ±5% tester tolerance
- [5] 'Operating Voltage' doesn't indicate the maximum voltage which customers use, but it means tolerable voltage according to the voltage variation rate by one's country.
It is recommended that the temperature of solder pad should be below 70°C.

Optical and thermal characteristics

2. SAW84A0C (AN4240-03)

1-1 Electro-Optical characteristics at 55V[RMS] Ta=25°C

Parameter	Symbol	Value			Unit
		Min	Typ	Max	
Luminous Flux ^[1]	Φ_V ^[2]	-	65	-	lm
Illuminance ^[3]	Φ_I	-	-	-	lx
Correlated Color Temperature ^[4]	CCT	-	3000	-	K
CRI	R _a	75	80	-	-
Operating Current	I _{opt}	-	20	-	mA [RMS]
Power Dissipation	P _D	0.83			W
Operating Frequency	Freq	50/60			Hz
Thermal resistance	R _{th}	-			°C/W
View Angle	2 Θ 1/2	135			deg.

1-2 Absolute Maximum Ratings

Parameter	Symbol	Value	Unit
Operating Voltage	V _{opt} ^[5]	63	V [RMS]
Power Dissipation	P _D	-	W
Junction Temperature	T _j	125	°C
Operating Temperature	T _{opr}	-30 ~ +85	°C
Storage Temperature	T _{stg}	-40 ~ +120	°C
ESD Sensitivity	-	±6,000V HBM	-

* Notes :

- [1] Acrich series maintains a tolerance of ±10% on flux and power measurements and ± 2 on CRI measurements.
- [2] Φ_V is the total luminous flux output as measured with an integrating sphere.
- [3] Illuminance is measured at 50cm distance
- [4] Correlated Color Temperature is derived from the CIE 1931 Chromaticity diagram.
CCT ±5% tester tolerance
- [5] 'Operating Voltage' doesn't indicate the maximum voltage which customers use, but it means tolerable voltage according to the voltage variation rate by one's country.
It is recommended that the temperature of solder pad should be below 70°C.

Color spectrum, Ta=25°C

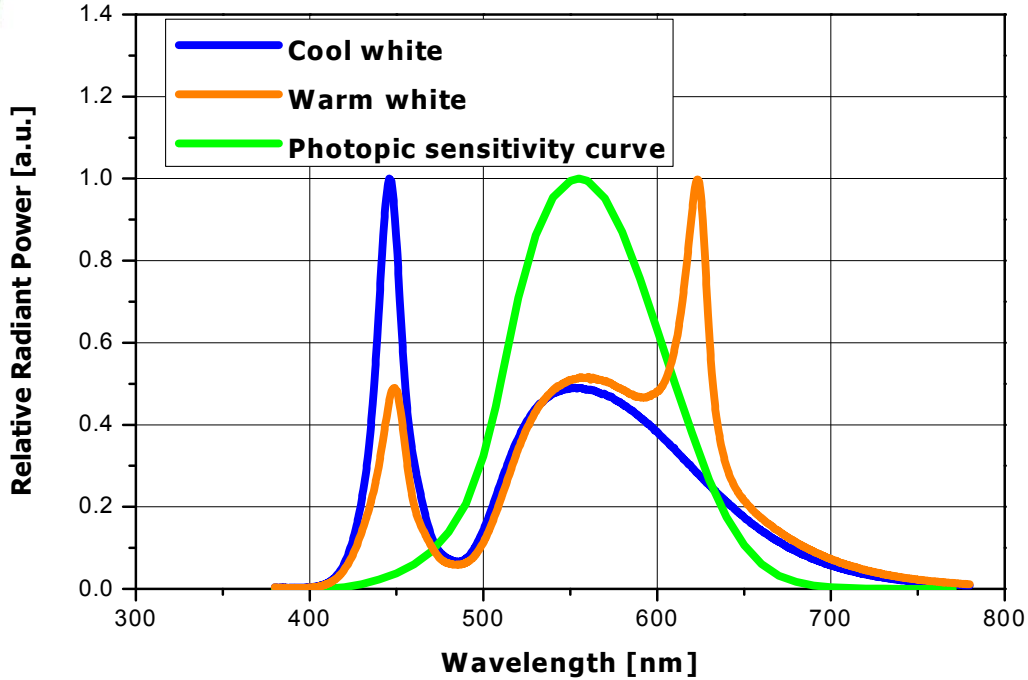

Radiation pattern, Ta=25°C

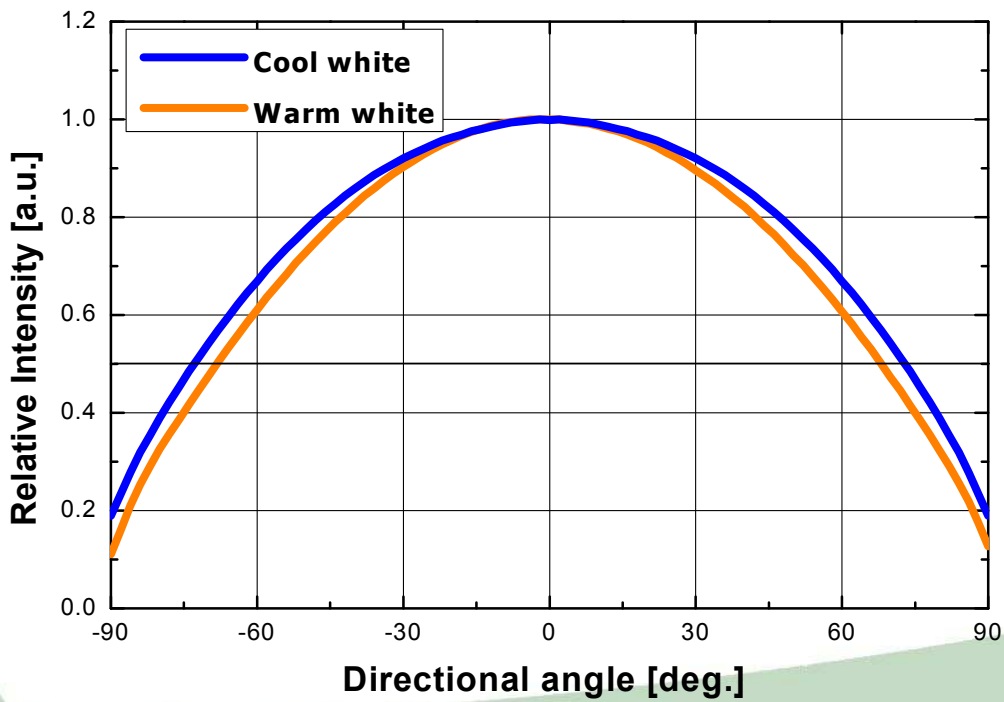

IV characteristics, Ta=25°C

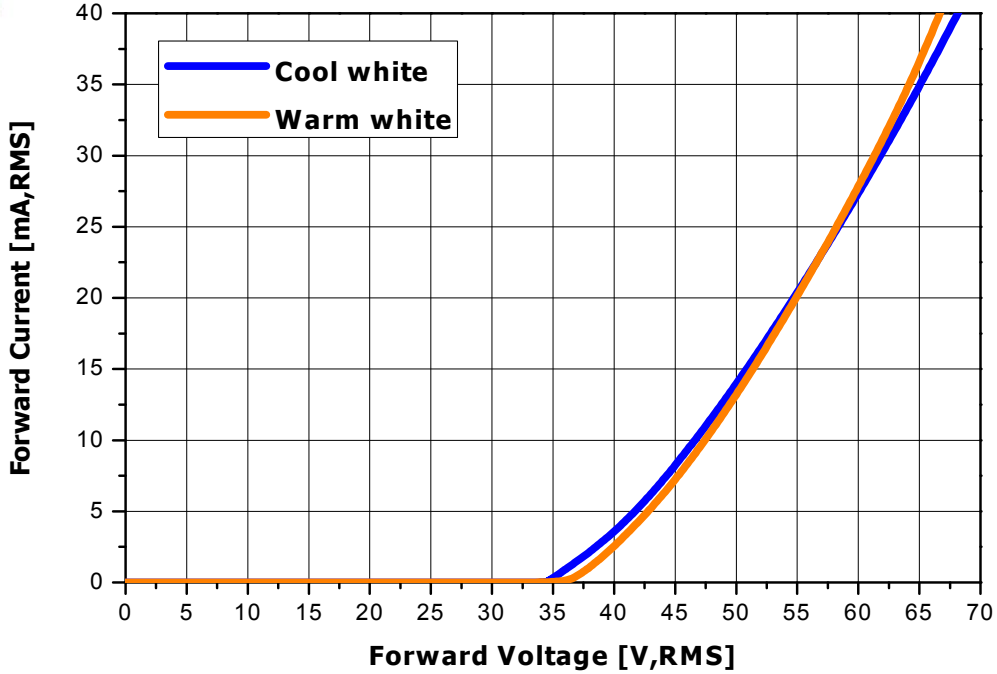

Relative Flux vs. Forward voltage

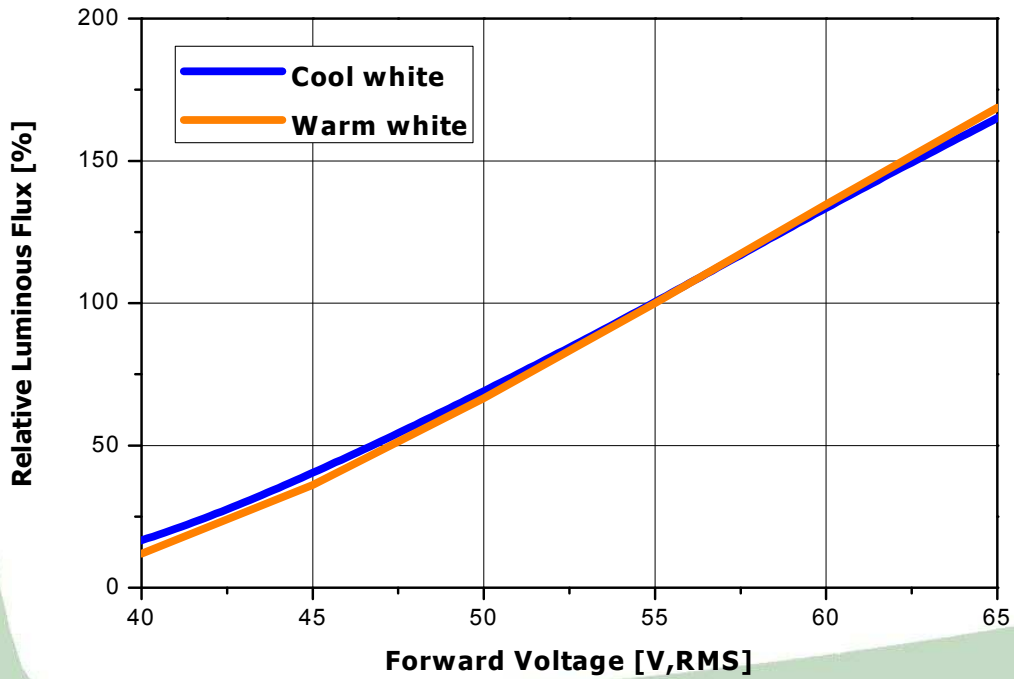

Relative Flux vs. Junction temperature
(20mA,RMS @ 55V,RMS / Tj=25°C)

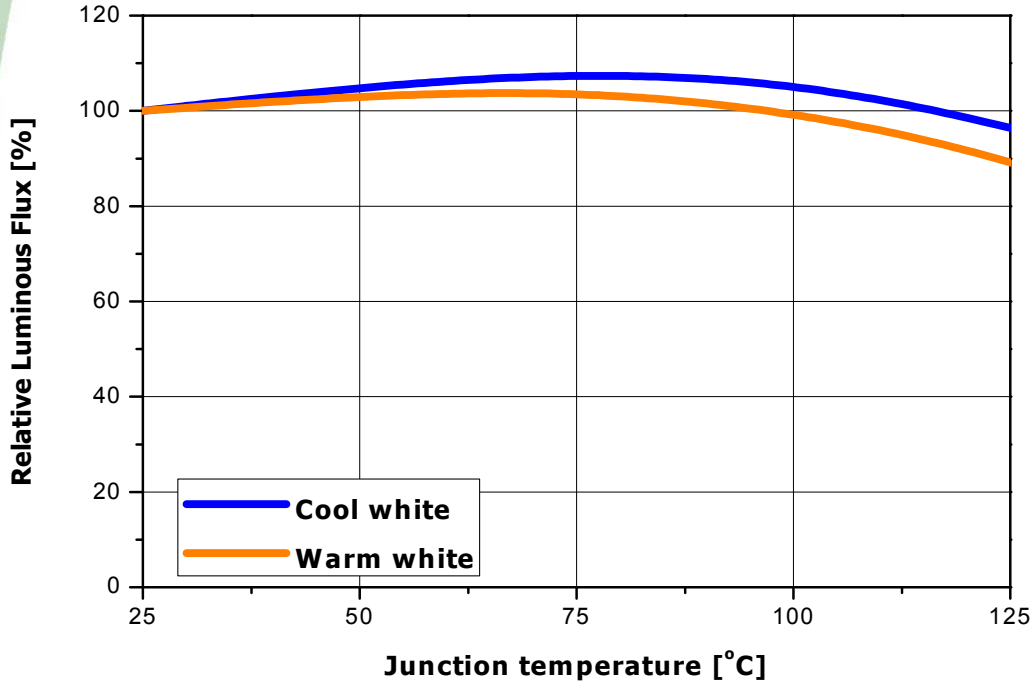

Forward Current vs. Junction temperature
(20mA,RMS @ 55V,RMS / Tj=25°C)

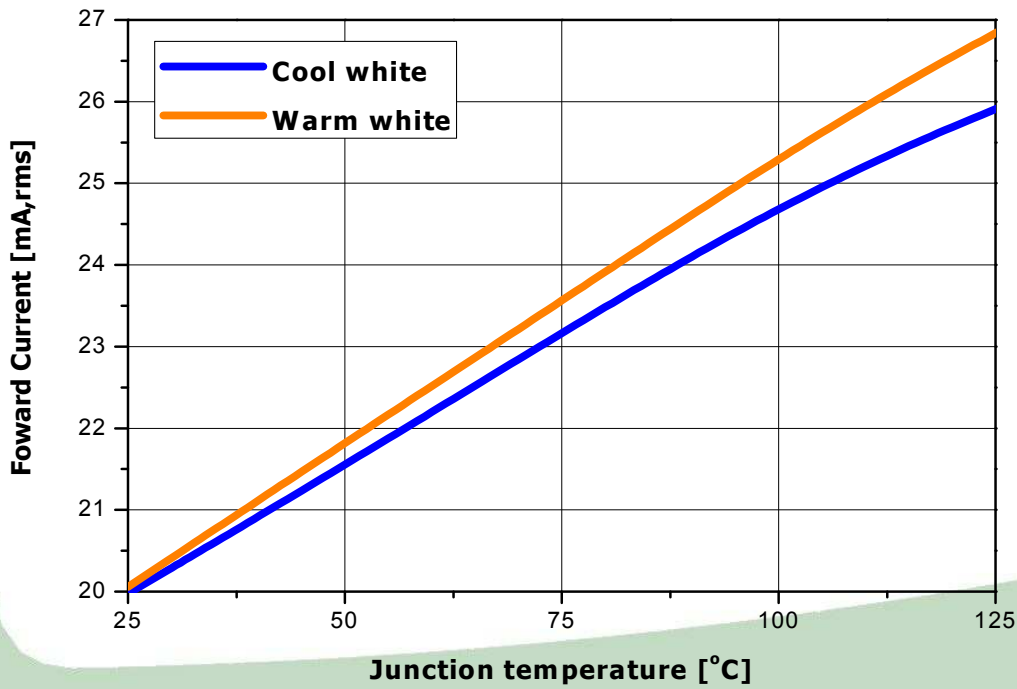

Acriche Binning structure graphical representation

1. SAW04A0A/SAW84 A0C

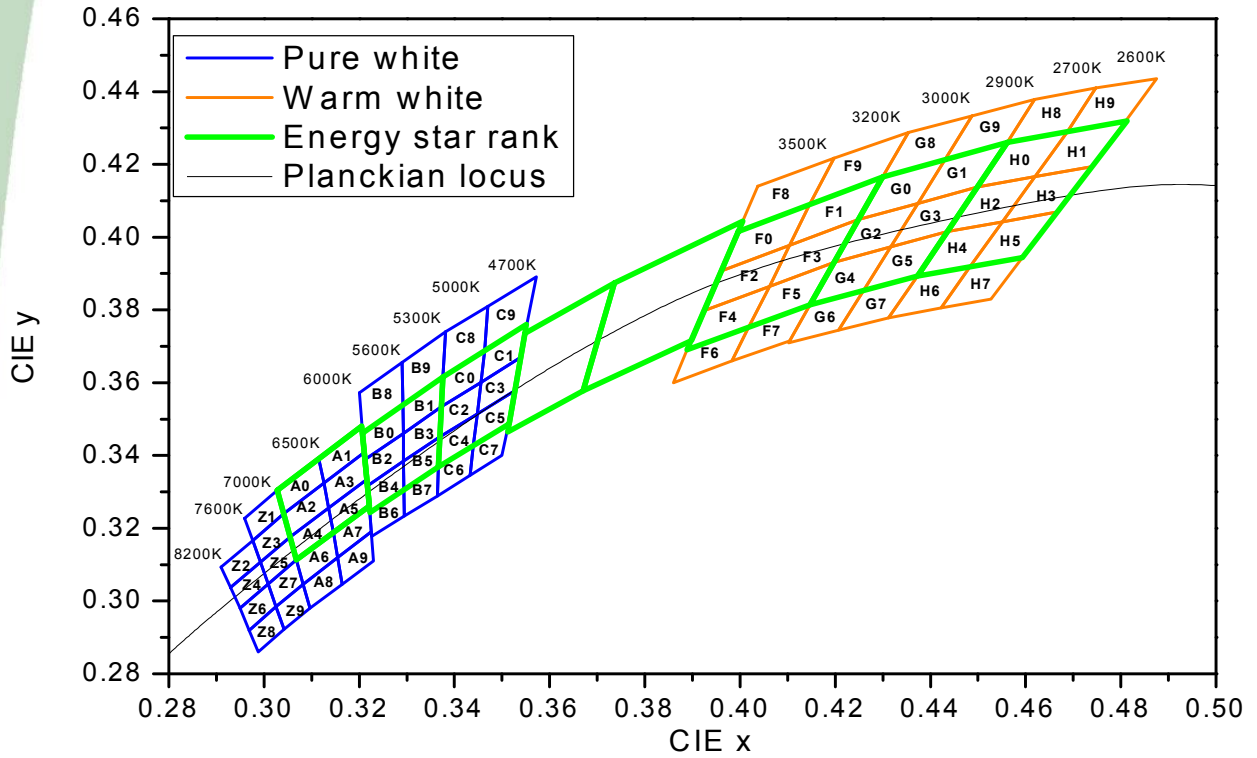

*Notes : For more detailed information on Acriche binning see the "Acriche Binning and Labeling" document at www.Acriche.com

Operating instructions

1. Basic connections of SAWX4A0X for AC source

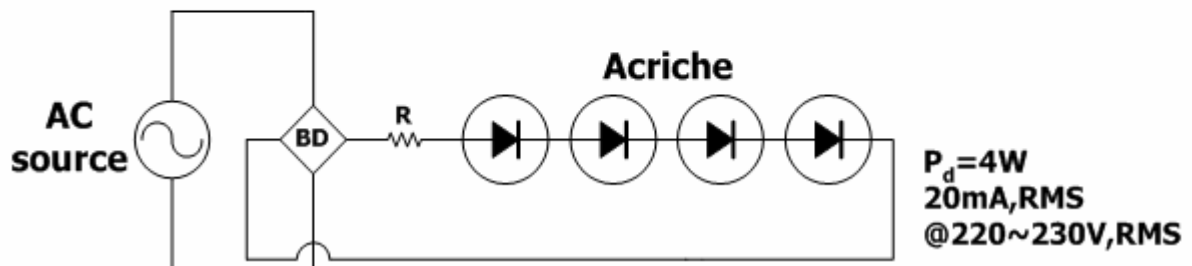
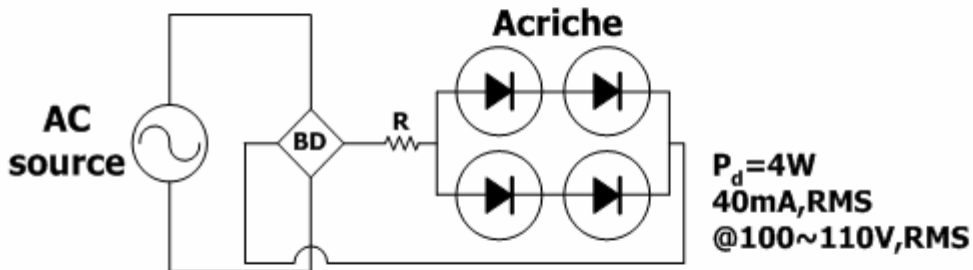
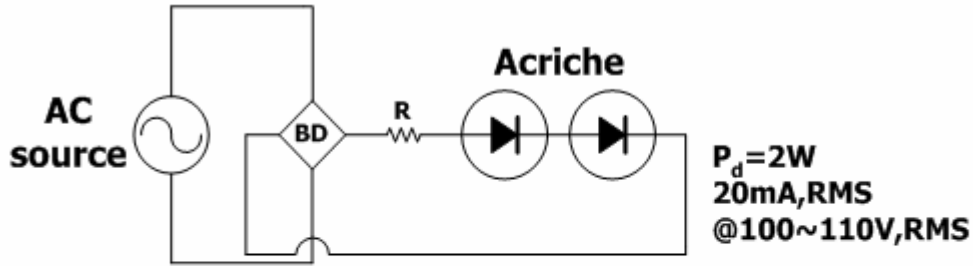

* Notes :

- [1] A4 series need bridge diode and external resistor.
- [2] The tolerance of current is $\pm 10\%$ on each resistance rank.
- [3] For more information about Acrich connection, refer to the Application Note.

Emitter Reel Packaging

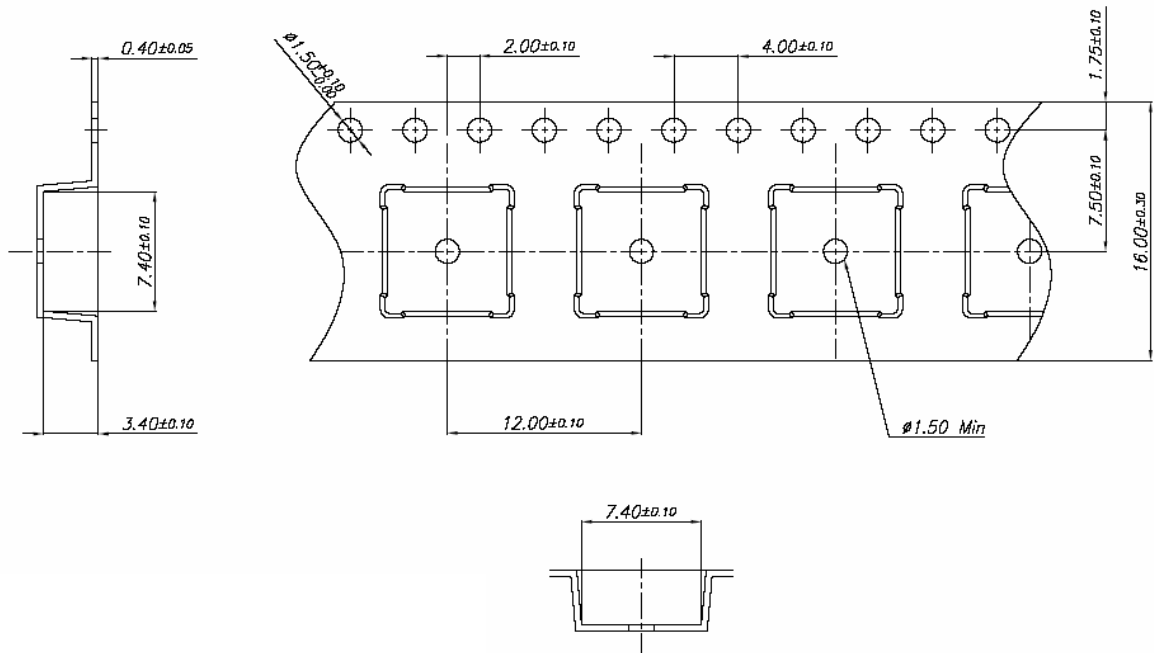
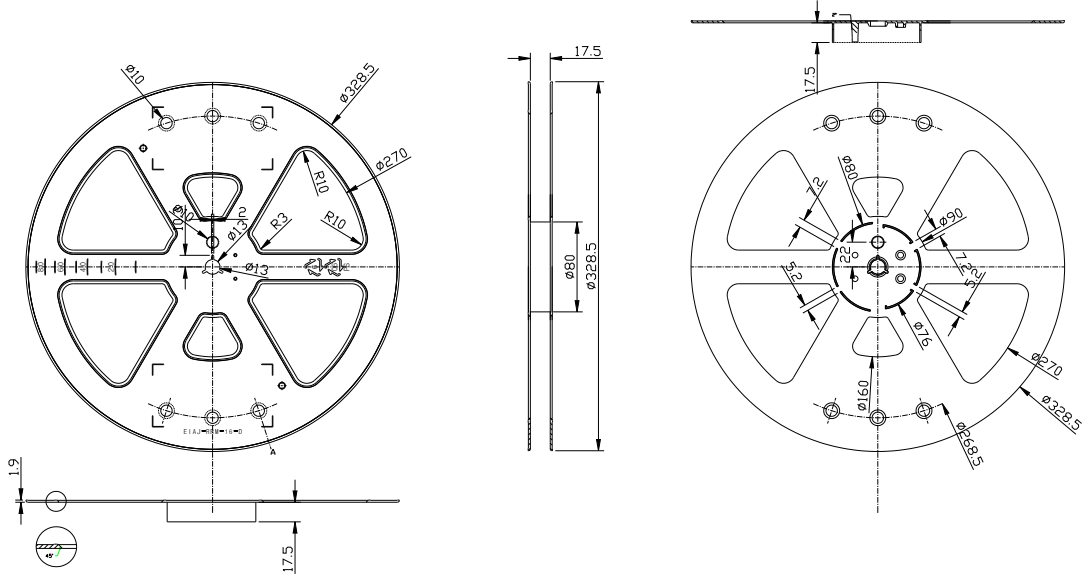

* Notes :

- [1] The number of loaded products in the reel is 500 or 1000ea
- [2] All dimensions are in millimeters (tolerance : ± 0.2)
- [3] Scale none

Solder profile

1. Reflow solder conditions / profile

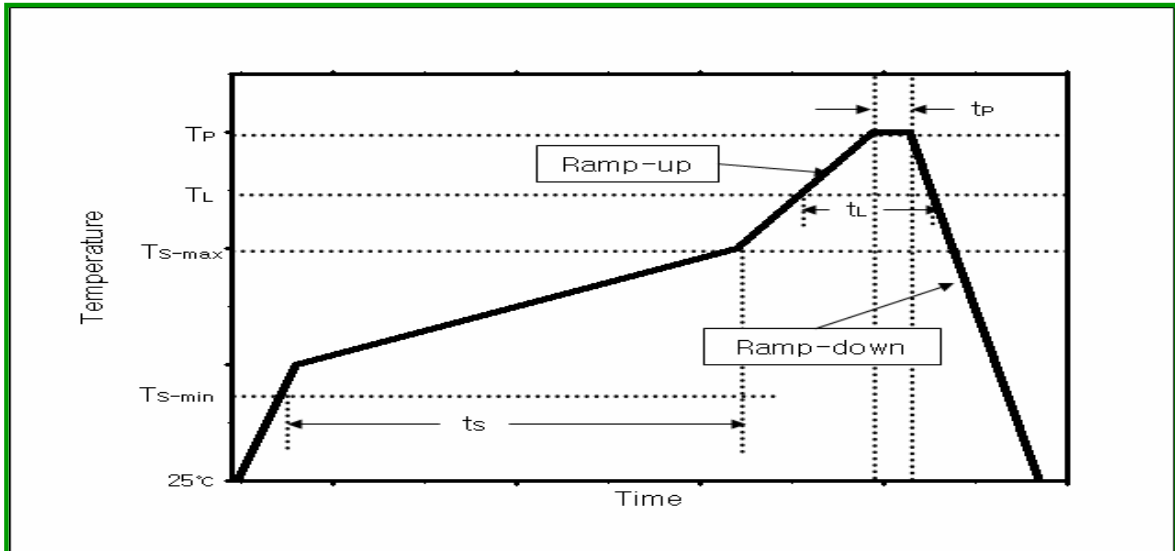

Reflow condition	Pb-Free assembly
Average ramp-up rate (TS-max to Peak)	2~3°C / second
Preheat Temperature Min (TS-min)	150°C
Preheat Temperature Max (TS-max)	200°C
Time maintained above: : Liquidus Temperature (TL)	217~220°C
Time maintained above: Time (tL)	60~150 seconds
Peak Temperature (TP)	250°C
Time within 5°C of actual Peak Temperature (tp)	20~40 seconds
ramp-down rate	4~6°C / second
Time 25°C to Peak Temperature	6 minutes max

2. Hand Solder conditions

- 2-1 Lead : Not more than 3 seconds @MAX280°C
- 2-2 Slug : Use a thermal-adhesives

*** Caution**

- [1] Reflow soldering should not be done more than one time.
- [2] Repairing should not be done after the LEDs have been soldered. When repairing is unavoidable, suitable tools have to be used.
- [3] Die slug is to be soldered.
- [4] When soldering, do not put stress on the LEDs during heating.
- [5] After soldering, do not warp the circuit board.
- [6] Recommend to use a convection type reflow machine with 7 ~ 8 zones. Rev. 07

September 2012

Precautions for use

- [1] Please note Acrich runs on high voltage so use caution when near the leads or if a dome is inadvertently removed while circuit is active
- [2] Please do not touch any of the circuit board, components or terminals with bare hands or metal while circuit is electrically active.
- [3] Please do not add or change wires while Acrich circuit is active

Handling of silicone resin for LEDs

- [1] Acrich series is encapsulated by silicone resin for the highest flux efficiency.
- [2] Avoid touching silicone resin portion of LED especially with sharp tools such as Pincette (tweezers).
- [3] Avoid leaving fingerprints on silicone resin parts.
- [4] Silicone resin is dust sensitive and needs a covered container for storage
- [5] When populating boards in SMT production there are no unusual restrictions regarding the form of the pick and place nozzle except that mechanical stress on the surface of the resin must be avoided.
- [6] Please do not apply diagonal force to the silicone lens in excess of 3000gf or permanent and fatal damage will occur.
- [7] Please do not cover the silicone resin with any other resin (epoxy, urethane, etc)