



SPECIFICATION

[STW0Q14A]

CUSTOMER

Checked by	Approved by

SUPPLIER

Drawn by	Approved by

CONTENTS

- 1. Description**
- 2. Absolute Maximum Ratings**
- 3. Electro-Optical Characteristics**
- 4. Optical characteristics**
- 5. Reliability Test Items and Conditions**
- 6. Color & Binning**
- 7. Bin Code Description**
- 8. Outline Dimension**
- 9. Material Structure**
- 10. Reel Structure**
- 11. Packing**
- 12. Soldering**
- 13. Precaution for use**
- 14. Handling of Silicone Resin LEDs**

STW0Q14A

1. Description

This surface-mount LED comes in standard package dimension. It has a substrate made up of a molded plastic reflector sitting on top of a bent lead frame. The die is attached within the reflector cavity and the cavity is encapsulated by silicone.

The package design coupled with careful selection of component materials allow these products to perform with high reliability.

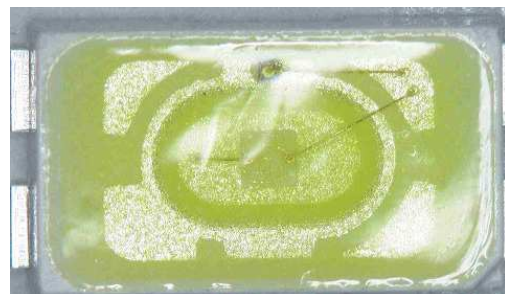

Features

- Pb-Free Reflow soldering application
- RoHS compliant
- White colored SMT package
- Suitable for all SMT assembly and soldering methods
- High Reliability (silicone resin)

Applications

- Electric Signs and Signals
- Office Automation, Electrical Appliances, Industrial Equipment

2. Absolute maximum ratings*1

Parameter	Symbol	Value	Unit
Power Dissipation	P_d	272	mW
Forward Current	I_F	80	mA
Peak Forward Current	$I_{FM}^{[2]}$	150	mA
Operating Temperature	T_{opr}	-40 ~ +85	℃
Storage Temperature	T_{stg}	-40 ~ +100	℃
Junction Temperature	T_j	125	℃

[1] Care is to be taken that power dissipation does not exceed the absolute maximum rating of the product.

[2] IFM was measured at $T_w \leq 1$ msec of pulse width and $D \leq 1/10$ of duty ratio.

[3] LED's properties might be different from suggested values like above and below tables if operation condition will be exceeded our parameter range.

3. Electric characteristics

Parameter	Symbol	Condition	Min.	Typ.	Max.	Unit
Forward Voltage * ^[1]	V_F	$I_F = 60\text{mA}$	2.9	3.2	3.4	V
Reverse Voltage	V_R	$I_R = 5\text{mA}$	-	0.85	1.2	V
Luminous Intensity* ^[2]	I_v	$I_F = 60\text{mA}$	-	5.2	-	cd
Luminous flux	Φ	$I_F = 60\text{mA}$	-	15	-	lm
Color Correlated Temperature	CCT	$I_F = 60\text{mA}$	4700	-	8200	K
Viewing Angle ^[3]	$2\theta_{1/2}$	$I_F = 60\text{mA}$	-	120	-	deg.
Color Rendering Index*	Ra	$I_F = 60\text{mA}$	-	68	-	-
ESD (HBM)		1.5k Ω ;100pF	5	-	-	KV
Thermal resistance ^[4]	R_{thJS}	$I_F = 60\text{mA}$		22		°C/W

[1] Forward current is 60mA per die.

[2] The luminous intensity I_v was measured at the peak of the spatial pattern which may not be aligned with the mechanical axis of the LED package.

[3] $2\theta_{1/2}$ is the off-axis where the luminous intensity is 1/2 of the peak intensity.

[4] Thermal resistance: R_{thJS} (Junction / solder), Metal PCB 25*25mm 1.6t

* Tolerance : $V_F : \pm 0.1V$, $I_v : \pm 10\%$, $x, y : \pm 0.01$

[Note] All measurements were made under the standardized environment of SSC.

4. Optical characteristics

Forward Voltage vs. Forward Current

Ta=25°C

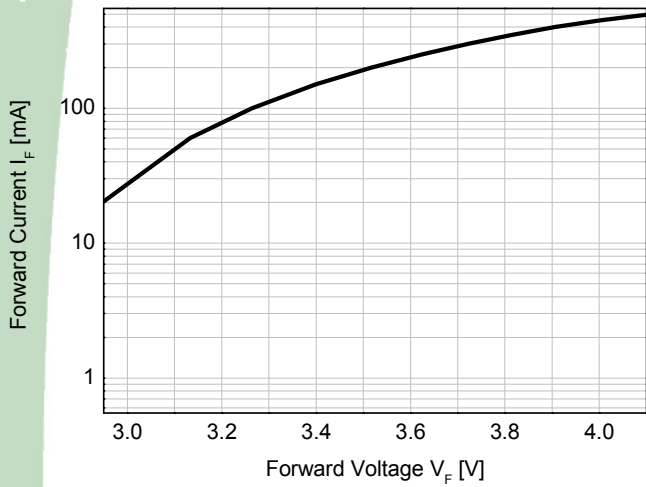

Forward Current vs. Relative Luminous Intensity

Ta=25°C

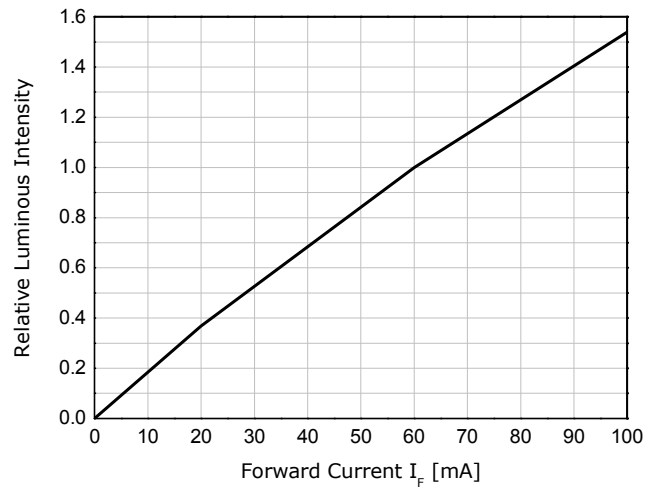

Forward Current vs. Chromaticity Coordinate

Ta=25°C

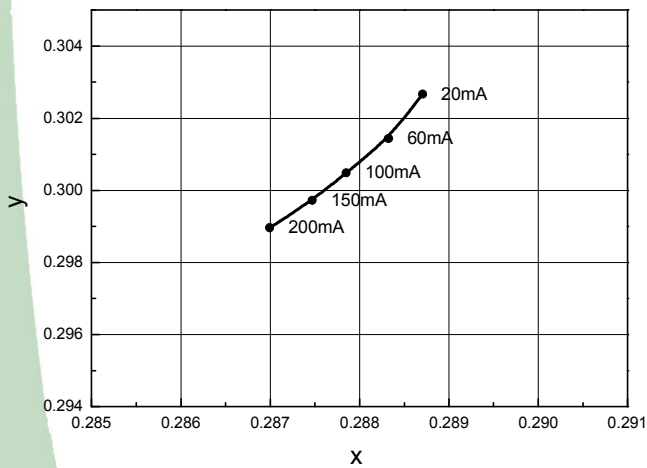

Directivity

Ta=25°C

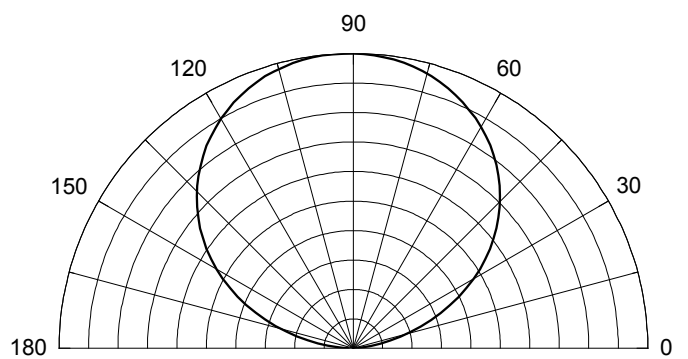

Forward Voltage Shift
vs. Junction Temperature

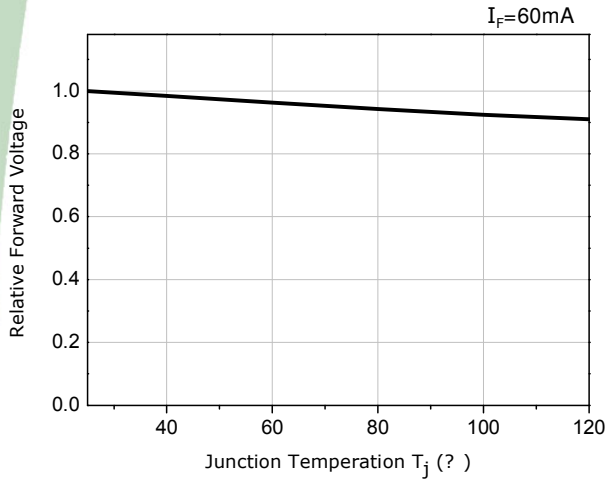

Relative Light Output
vs. Junction Temperature

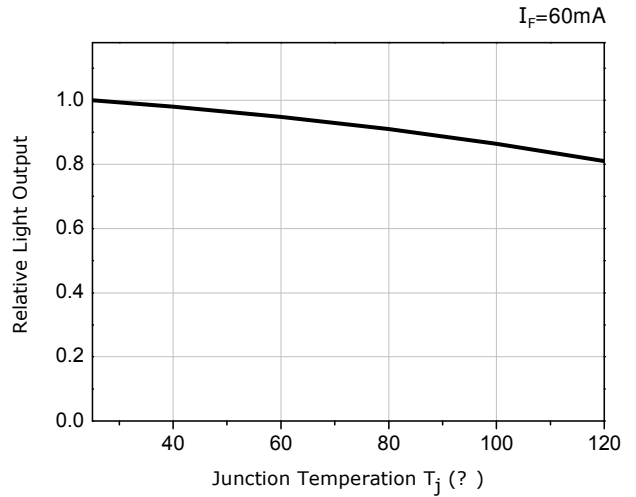

Junction Temperature (°C)
vs. Chromaticity Coordinate

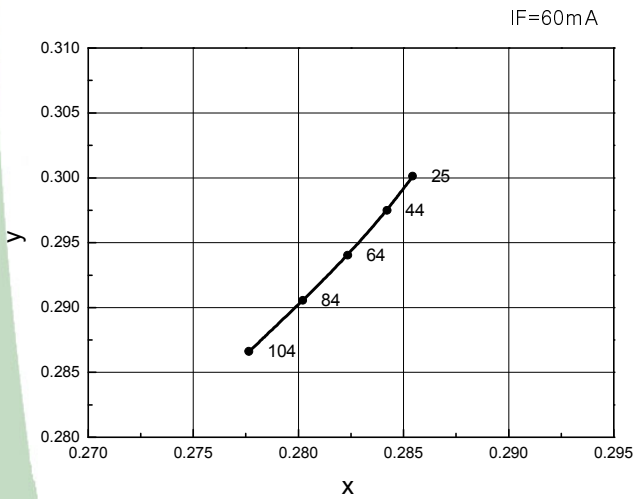

Ambient Temperature vs. Maximum Forward Current

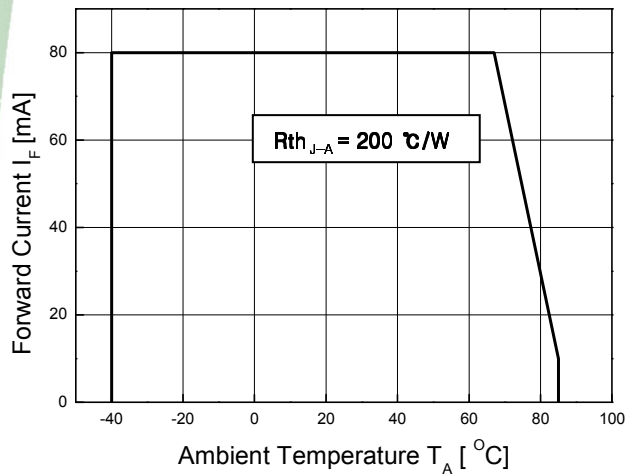

Spectrum

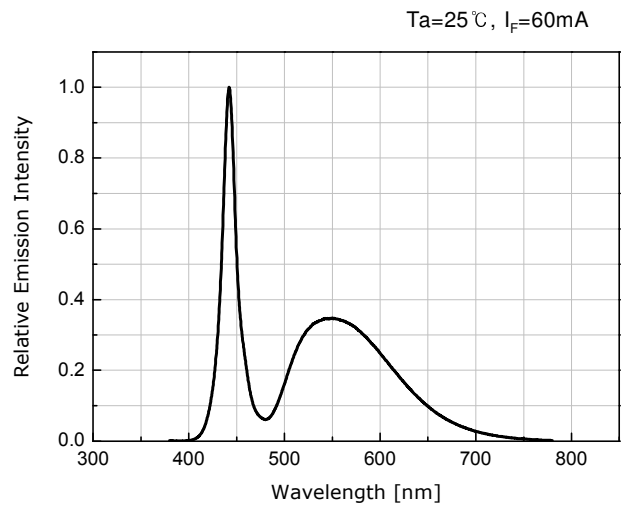

5. Reliability Test Items and Conditions

Item	Reference	Test Conditions	Duration / Cycle	Number of Damaged
Thermal Shock	EIAJ ED-4701	$T_a = -40^{\circ}\text{C}(30\text{min}) \sim 100^{\circ}\text{C}(30\text{min})$	100 Cycle	0/22
High Temperature Storage	EIAJ ED-4701	$T_a = 100^{\circ}\text{C}$	1000 Hours	0/22
High Temp. High Humidity Storage	EIAJ ED-4701	$T_a = 60^{\circ}\text{C}, \text{RH}=90\%$	1000 Hours	0/22
Low Temperature Storage	EIAJ ED-4701	$T_a = -40^{\circ}\text{C}$	1000 Hours	0/22
Operating Endurance Test	Internal Reference	$T_a = 25^{\circ}\text{C}, I_F = 60\text{mA}$	1000 Hours	0/22
High Temperature High Humidity Life Test	Internal Reference	$T_a = 60^{\circ}\text{C}, \text{RH}=90\%, I_F = 60\text{mA}$	500 Hours	0/22
High Temperature Life Test	Internal Reference	$T_a = 85^{\circ}\text{C}, I_F = 60\text{mA}$	500 Hours	0/22
Low Temperature Life Test	Internal Reference	$T_a = -40^{\circ}\text{C}, I_F = 60\text{mA}$	1000 Hours	0/22
ESD(HBM)	MIL-STD-883D	5KV at 1.5k Ω ; 100pF	3 Time	0/22
Reflow	T_{sol}	260 $^{\circ}\text{C}$ < 10sec. Reflow Soldering	3 Time	0/22

□ CRITERIA FOR JUDGING THE DAMAGE

Item	Symbol	Condition	Criteria for Judgment	
			MIN	MAX
Forward Voltage	V_F	$I_F = 60\text{mA}$	-	USL ^[1] × 1.2
Luminous Intensity	I_V	$I_F = 60\text{mA}$	LSL ^[2] × 0.7	-

Note : [1] USL : Upper Standard Level
 [2] LSL : Lower Standard Level

6. Color & Binning

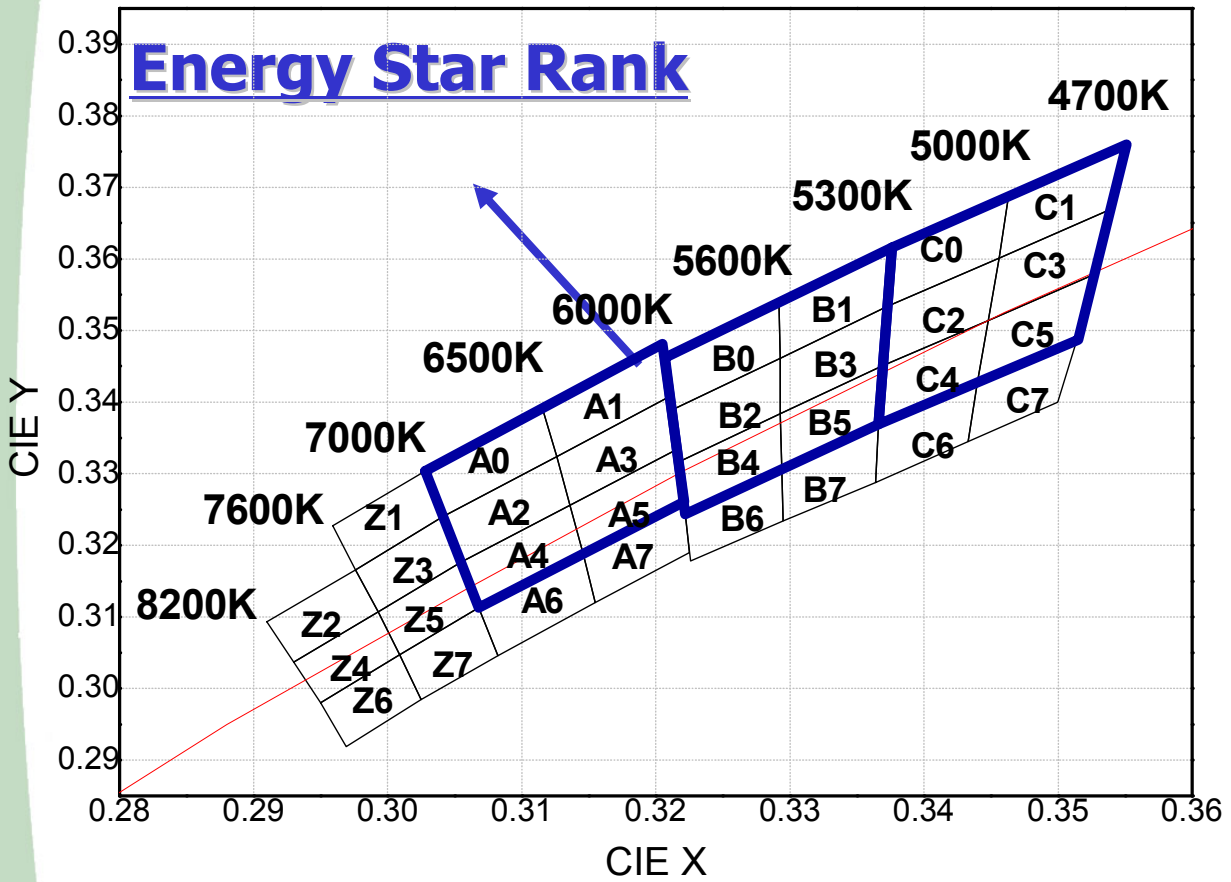



6. Color & Binning

● COLOR RANK

<IF=60mA, Ta=25℃>

Z1		Z2		Z3		Z4		Z5	
CIE X	CIE Y	CIE X	CIE Y	CIE X	CIE Y	CIE X	CIE Y	CIE X	CIE Y
0.2959	0.3227	0.291	0.3093	0.2976	0.3166	0.293	0.3037	0.2993	0.3107
0.2976	0.3166	0.293	0.3037	0.2993	0.3107	0.295	0.298	0.3009	0.3047
0.3041	0.324	0.2993	0.3107	0.3055	0.3177	0.3009	0.3047	0.3068	0.3113
0.3028	0.3304	0.2976	0.3166	0.3041	0.324	0.2993	0.3107	0.3055	0.3177
Z6		Z7							
CIE X	CIE Y	CIE X	CIE Y						
0.295	0.298	0.3009	0.3047						
0.2969	0.2919	0.3025	0.2985						
0.3025	0.2985	0.3082	0.3046						
0.3009	0.3047	0.3068	0.3113						
A0		A1		A2		A3		A4	
CIE X	CIE Y	CIE X	CIE Y	CIE X	CIE Y	CIE X	CIE Y	CIE X	CIE Y
0.3028	0.3304	0.3115	0.3393	0.3041	0.3240	0.3126	0.3324	0.3055	0.3177
0.3041	0.3240	0.3126	0.3324	0.3055	0.3177	0.3136	0.3256	0.3068	0.3113
0.3126	0.3324	0.3210	0.3408	0.3136	0.3256	0.3216	0.3334	0.3146	0.3187
0.3115	0.3393	0.3205	0.3481	0.3126	0.3324	0.3210	0.3408	0.3136	0.3256
A5		A6		A7					
CIE X	CIE Y	CIE X	CIE Y	CIE X	CIE Y				
0.3136	0.3256	0.3068	0.3113	0.3146	0.3187				
0.3146	0.3187	0.3082	0.3046	0.3155	0.3120				
0.3221	0.3261	0.3155	0.3120	0.3225	0.3190				
0.3216	0.3334	0.3146	0.3187	0.3221	0.3261				



6. Color & Binning

● COLOR RANK

<IF=60mA, Ta=25℃>

B0		B1		B2		B3		B4	
CIE X	CIE Y	CIE X	CIE Y	CIE X	CIE Y	CIE X	CIE Y	CIE X	CIE Y
0.3207	0.3462	0.3292	0.3539	0.3212	0.3389	0.3293	0.3461	0.3217	0.3316
0.3212	0.3389	0.3293	0.3461	0.3217	0.3316	0.3293	0.3384	0.3222	0.3243
0.3293	0.3461	0.3373	0.3534	0.3293	0.3384	0.3369	0.3451	0.3294	0.3306
0.3292	0.3539	0.3376	0.3616	0.3293	0.3461	0.3373	0.3534	0.3293	0.3384
B5		B6		B7					
CIE X	CIE Y	CIE X	CIE Y	CIE X	CIE Y				
0.3293	0.3384	0.3222	0.3243	0.3294	0.3306				
0.3294	0.3306	0.3226	0.3178	0.3295	0.3234				
0.3366	0.3369	0.3295	0.3234	0.3364	0.3288				
0.3369	0.3451	0.3294	0.3306	0.3366	0.3369				
C0		C2		C4		C6			
CIE X	CIE Y	CIE X	CIE Y	CIE X	CIE Y	CIE X	CIE Y		
0.3376	0.3616	0.3373	0.3534	0.3369	0.3451	0.3366	0.3369		
0.3373	0.3534	0.3369	0.3451	0.3366	0.3369	0.3364	0.3288		
0.3456	0.3601	0.3448	0.3514	0.344	0.3428	0.3433	0.3345		
0.3463	0.3687	0.3456	0.3601	0.3448	0.3514	0.344	0.3428		
C1		C3		C5		C7			
CIE X	CIE Y	CIE X	CIE Y	CIE X	CIE Y	CIE X	CIE Y		
0.3463	0.3687	0.3456	0.3601	0.3448	0.3514	0.344	0.3428		
0.3456	0.3601	0.3448	0.3514	0.344	0.3428	0.3433	0.3345		
0.3539	0.3669	0.3526	0.3578	0.3514	0.3487	0.35	0.34		
0.3552	0.376	0.3539	0.3669	0.3526	0.3578	0.3514	0.3487		

7. Bin Code Description

Bin Code		
Luminous Intensity	CIE	Forward Voltage
N0	A0	Z1



Luminous Intensity (cd) @ $I_F = 60\text{mA}$			Flux [lm]
Bin Code	Min.	Max.	Typ
N0	5.0	5.5	16.5
N5	5.5	6.0	17.7
P0	6.0	6.5	19.2
P5	6.5	7.0	21

Color Rank @ $I_F = 60\text{mA}$
Z~C

Forward Voltage (V) @ $I_F = 60\text{mA}$		
Bin Code	Min.	Max.
Y3	2.9	3.0
Z1	3.0	3.1
Z2	3.1	3.2
Z3	3.2	3.3
A1	3.3	3.4

- Available ranks
- Not yet available ranks

CCT	IV Rank		
6000~8200K (CIE Z,A)	N0	N5	P0
4700~6000 K (CIE B,C)	N0	N5	P0

[Note] All measurements were made under the standardized environment of SSC.
In order to ensure availability, single color rank will not be orderable.

8. Outline Dimension

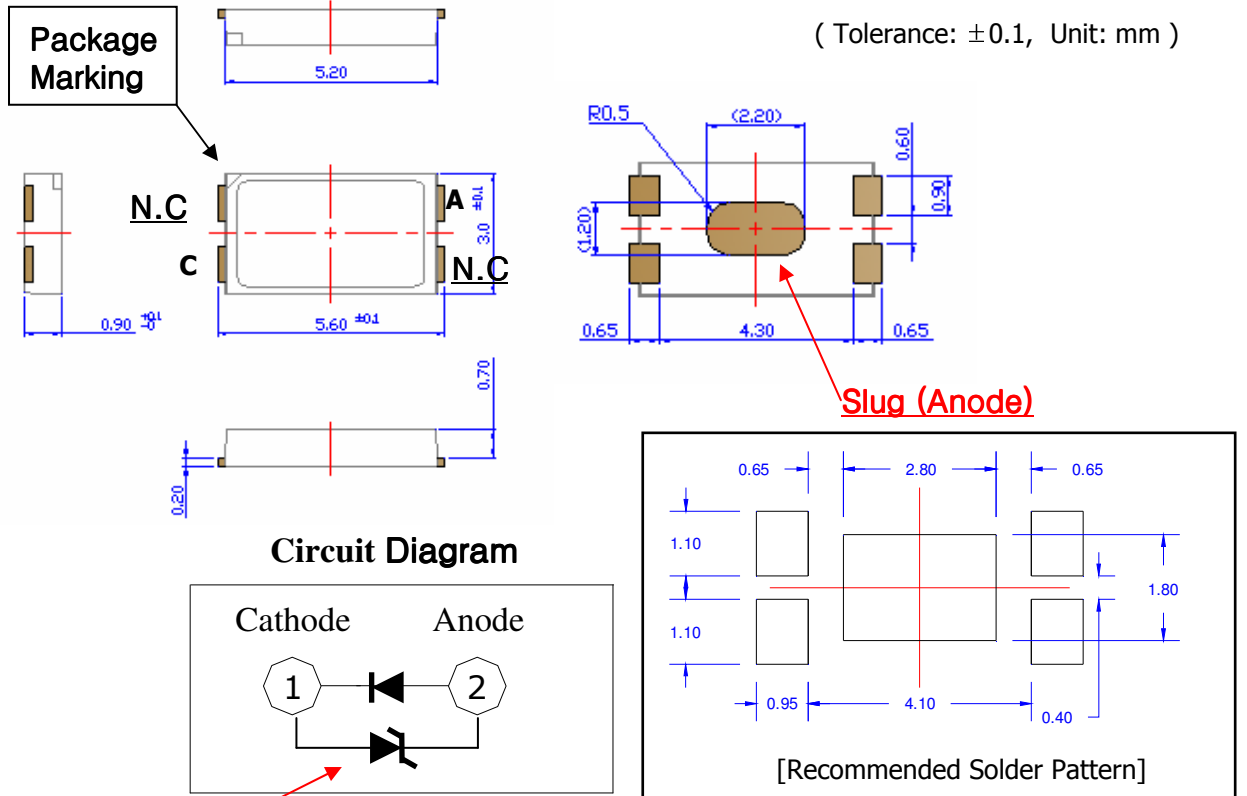

ESD Protection Device

[Note] Package Forward Current is 100mA

9. Material Structure

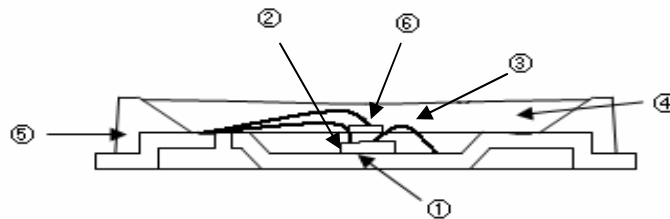

Parts No.	Name	Description	Materials
①	LEAD FRAME	Metal	Copper Alloy (Silver Plated)
②	Chip Source	Blue LED	GaN on Sapphire
③	Wire	Metal	Gold Wire
④	Encapsulation	Silicone	+Phosphor
⑤	Body	Thermo Plastic	Heat- resistant Polymer
⑥	Zener Diode	Si	-

10. Reel Structure

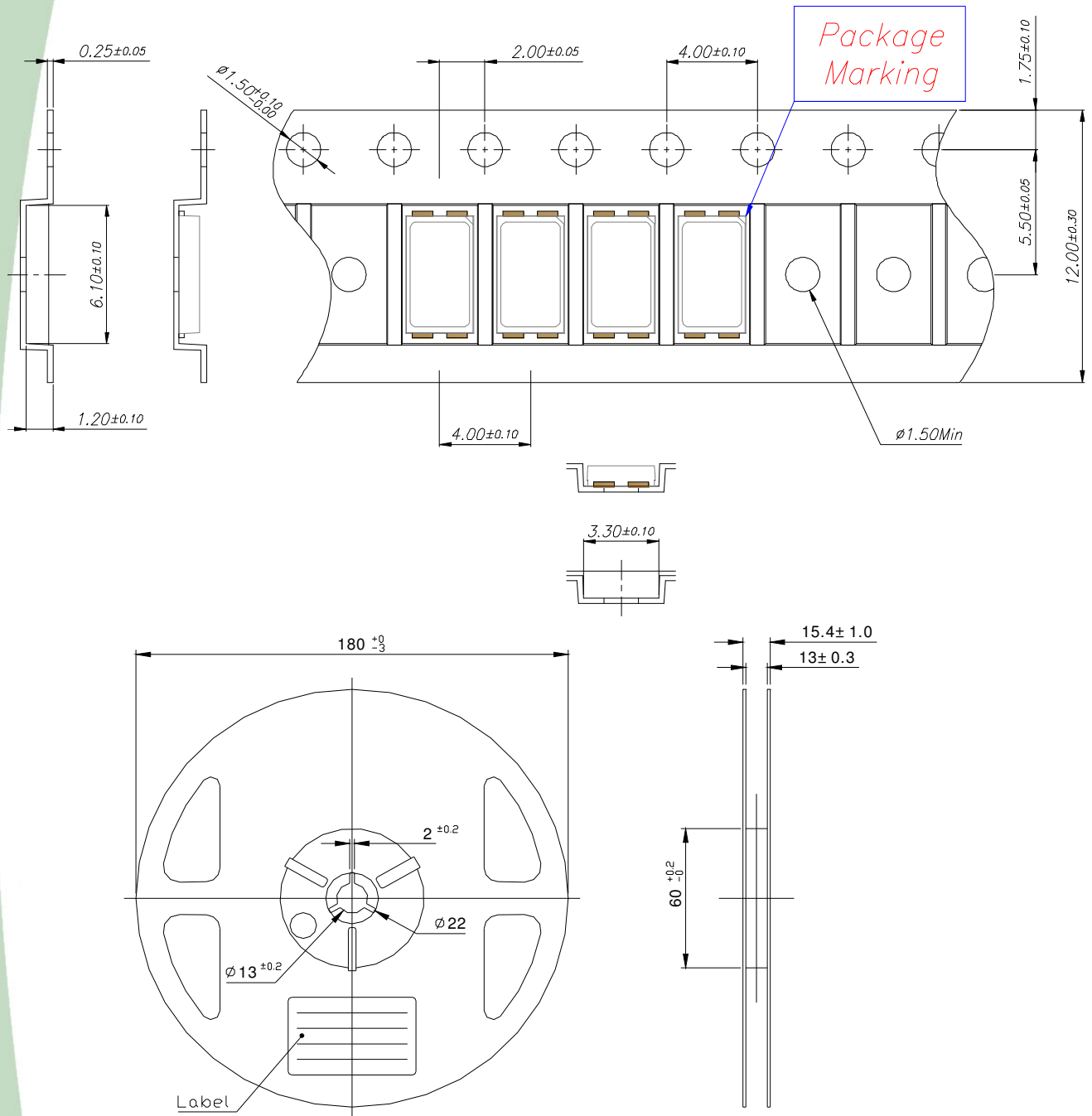

(Tolerance: ± 0.2 , Unit: mm)

- (1) Quantity : 3,500pcs/Reel
- (2) Cumulative Tolerance : Cumulative Tolerance/10 pitches to be ± 0.2 mm
- (3) Adhesion Strength of Cover Tape : Adhesion strength to be 0.1-0.7N when the cover tape is turned off from the carrier tape at the angle of 10° to the carrier tape
- (4) Package : P/N, Manufacturing data Code No. and quantity to be indicated on a damp proof Package

Rev. 02

April, 2011

Document No. : SSC- QP- 7- 07- 24

11. Soldering

(1) Lead Solder

Lead Solder	
Pre-heat	120~150 ℃
Pre-heat time	120 sec. Max.
Peak-Temperature	240 ℃ Max.
Soldering time Condition	10 sec. Max.

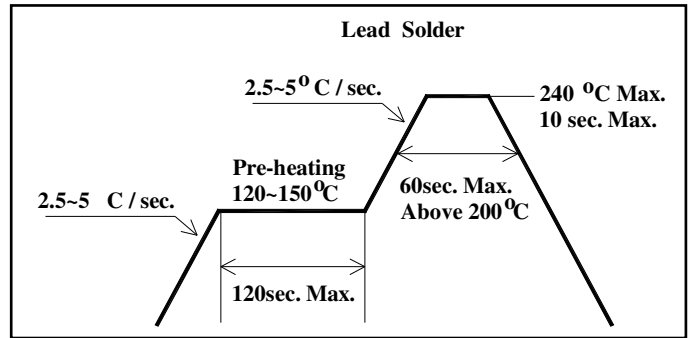

(2) Lead-Free Solder

Lead Free Solder	
Pre-heat	150~200 ℃
Pre-heat time	120 sec. Max.
Peak-Temperature	260 ℃ Max.
Soldering time Condition	10 sec. Max.

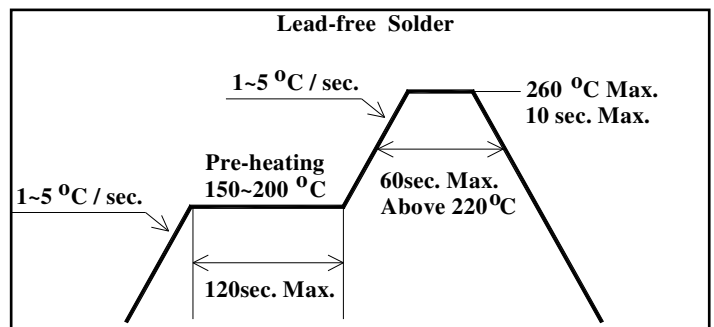

(3) Hand Soldering conditions

Do not exceed 4 seconds at maximum 315°C under soldering iron.

(4) The encapsulated material of the LEDs is silicone.

Precautions should be taken to avoid the strong pressure on the encapsulated part.

So when using the chip mounter, the picking up nozzle that does not affect the silicone resign should be used.

(5) It is recommended that the customer use the nitrogen reflow method.

(6) Repairing should not be done after the LEDs have been soldered.

(7) Reflow soldering should not be done more than two times.

In the case of more than 24 hours passed soldering after first, LEDs will be damaged.

12. Packing

Reel

RANK: XXXX
 QUANTITY : XXXX
 LOT NUMBER : XXXXXXXXXXXX
 PART NUMBER : XXXXXXXX
 SEOUL SEMICONDUCTOR CO., LTD.

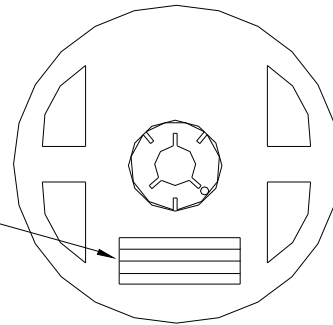

Aluminum Vinyl Bag

RANK: XXXX
 QUANTITY : XXXX
 LOT NUMBER : XXXXXXXXXXXX
 PART NUMBER : XXXXXXXX
 SEOUL SEMICONDUCTOR CO., LTD.

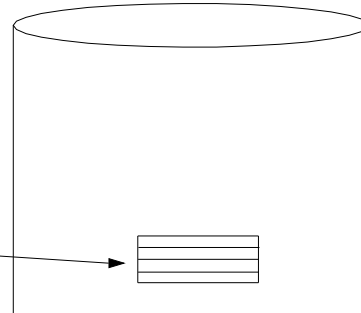

Outer Box Structure

Material : Paper(SW3B(B))

TYPE	SIZE (mm)		
	a	b	c
7inch	245	220	142

① SIDE

RANK: XXXX
 QUANTITY : XXXX
 LOT NUMBER : XXXXXXXXXXXX
 PART NUMBER : XXXXXXXX
 SEOUL SEMICONDUCTOR CO., LTD.

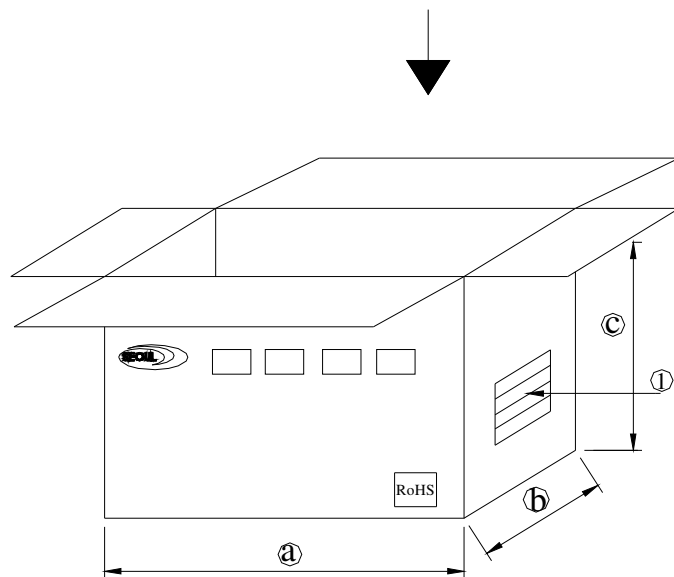

13. precaution for use

(1) Storage

In order to avoid the absorption of moisture, it is recommended to store in a dry box (or a desiccator) with a desiccant. Otherwise, to store them in the following environment is recommended.

Temperature : 5°C ~30°C Humidity : maximum 70%RH

(2) Attention after open.

LED is correspond to SMD, when LED be soldered dip, interfacial separation may affect the light transmission efficiency, causing the light intensity to drop.

Attention in followed; Keeping of a fraction

Temperature : 5 ~ 40°C Humidity : less than 10%

- (3) In the case of more than 1 week passed after opening or change color of indicator on desiccant, components shall be dried 10-12hr. at 60± 5°C.
- (4) Silver plating might be tarnished in the environment that contains corrosive gases and materials. Also any product that has tarnished lead might be decreased the solder-ability and optical-electrical properties compare to normal ones.
Please do not expose the product in the corrosive environment during the storage.
- (5) Any mechanical force or any excess vibration shall not be accepted to apply during cooling process to normal temperature after soldering.
- (6) Quick cooling shall be avoided.
- (7) Components shall not be mounted on warped direction of PCB.
- (8) Anti radioactive ray design is not considered for the products.
- (9) This device should not be used in any type of fluid such as water, oil, organic solvent etc. When washing is required, IPA should be used.
- (10) When the LEDs are illuminating, operating current should be decided after considering the ambient maximum temperature.
- (11) The LEDs must be soldered within seven days after opening the moisture-proof packing.
- (12) Repack unused products with anti-moisture packing, fold to close any opening and then store in a dry place.
- (13) The appearance and specifications of the product may be modified for improvement without notice.

14. Handling of Silicone Resin LEDs

1) During processing, mechanical stress on the surface should be minimized as much as possible. Sharp objects of all types should not be used to pierce the sealing compound.



2) In general, LEDs should only be handled from the side. By the way, this also applies to LEDs without a silicone sealant, since the surface can also become scratched.

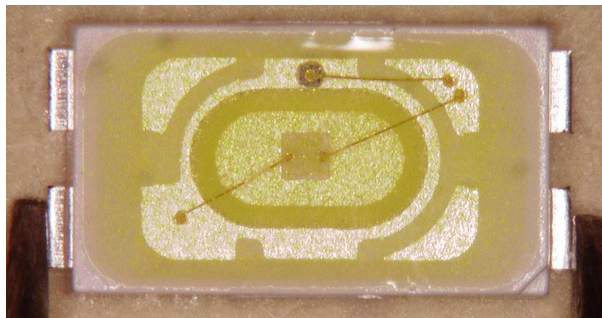

3) When populating boards in SMT production, there are basically no restrictions regarding the form of the pick and place nozzle, except that mechanical pressure on the surface of the resin must be prevented. This is assured by choosing a pick and place nozzle which is larger than the LED's reflector area.

4) Silicone differs from materials conventionally used for the manufacturing of LEDs. These conditions must be considered during the handling of such devices. Compared to standard encapsulants, silicone is generally softer, and the surface is more likely to attract dust.

As mentioned previously, the increased sensitivity to dust requires special care during processing. In cases where a minimal level of dirt and dust particles cannot be guaranteed, a suitable cleaning solution must be applied to the surface after the soldering of components.

5) SSC suggests using isopropyl alcohol for cleaning. In case other solvents are used, it must be assured that these solvents do not dissolve the package or resin. Ultrasonic cleaning is not recommended. Ultrasonic cleaning may cause damage to the LED.

6) Please do not mold this product into another resin (epoxy, urethane, etc) and do not handle this product with acid or sulfur material in sealed space.