

MOS FET Relays G3VM-61A1/D1

Compact, General-purpose, Analog-switching MOS FET Relay, with Dielectric Strength of 2.5 kVAC between I/O Using Optical Isolation

- Upgraded G3VM-61 A/D Series.
- Switches minute analog signals.
- RoHS Compliant.

■ **Application Examples**

- Measurement devices
- Security systems
- Amusement machines

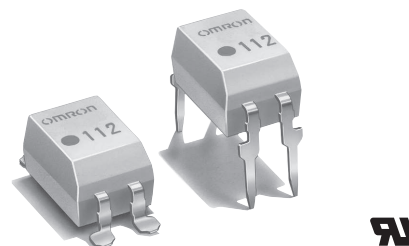

Note: The actual product is marked differently from the image shown here.

■ **List of Models**

Contact form	Terminals	Load voltage (peak value)	Model	Number per stick	Number per tape
SPST-NO	PCB terminals	60 VAC	G3VM-61A1	100	---
	Surface-mounting terminals		G3VM-61D1		
				G3VM-61D1(TR)	

■ **Dimensions**

Note: All units are in millimeters unless otherwise indicated.

G3VM-61A1

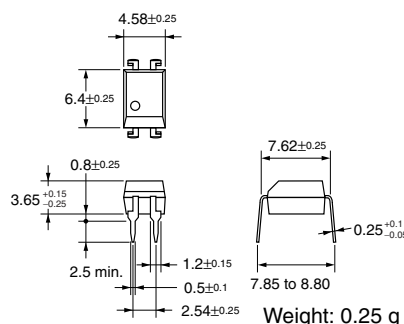

Note: The actual product is marked differently from the image shown here.

G3VM-61D1

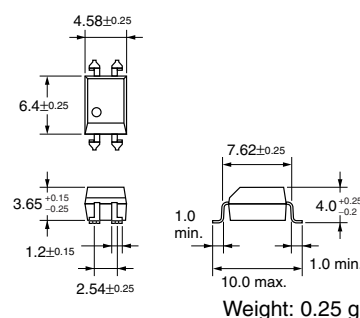

Note: The actual product is marked differently from the image shown here.

■ **Terminal Arrangement/Internal Connections (Top View)**

G3VM-61A1

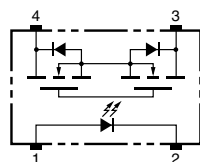

G3VM-61D1

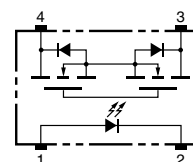

■ **PCB Dimensions (Bottom View)**

G3VM-61A1

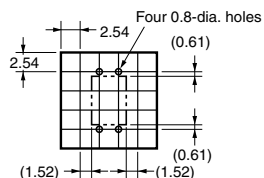

■ **Actual Mounting Pad Dimensions (Recommended Value, Top View)**

G3VM-61D1

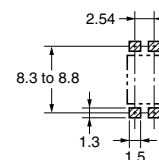

■ Absolute Maximum Ratings (Ta = 25°C)

Item		Symbol	Rating	Unit	Measurement conditions
Input	LED forward current	I_F	50	mA	
	Repetitive peak LED forward current	I_{FP}	1	A	100 μ s pulses, 100 pps
	LED forward current reduction rate	$\Delta I_F/^\circ\text{C}$	-0.5	mA/ $^\circ\text{C}$	Ta \geq 25 $^\circ\text{C}$
	LED reverse voltage	V_R	5	V	
	Connection temperature	T_j	125	$^\circ\text{C}$	
Output	Load voltage (AC peak/DC)	V_{OFF}	60	V	
	Continuous load current	I_O	500	mA	
	ON current reduction rate	$\Delta I_{ON}/^\circ\text{C}$	-5.0	mA/ $^\circ\text{C}$	Ta \geq 25 $^\circ\text{C}$
	Connection temperature	T_j	125	$^\circ\text{C}$	
Dielectric strength between input and output (See note 1.)		V_{I-O}	2,500	V_{rms}	AC for 1 min
Operating temperature		T_a	-40 to +85	$^\circ\text{C}$	With no icing or condensation
Storage temperature		T_{stg}	-55 to +125	$^\circ\text{C}$	With no icing or condensation
Soldering temperature (10 s)		---	260	$^\circ\text{C}$	10 s

Note: 1. The dielectric strength between the input and output was checked by applying voltage between all pins as a group on the LED side and all pins as a group on the light-receiving side.

■ Electrical Characteristics (Ta = 25°C)

Item		Symbol	Minimum	Typical	Maximum	Unit	Measurement conditions
Input	LED forward voltage	V_F	1.0	1.15	1.3	V	$I_F = 10$ mA
	Reverse current	I_R	---	---	10	μA	$V_R = 5$ V
	Capacity between terminals	C_T	---	30	---	pF	$V = 0$, $f = 1$ MHz
	Trigger LED forward current	I_{FT}	---	1.6	3	mA	$I_O = 500$ mA
Output	Maximum resistance with output ON	R_{ON}	---	1	2	Ω	$I_F = 5$ mA, $I_O = 500$ mA
	Current leakage when the relay is open	I_{LEAK}	---	0.001	1.0	μA	$V_{OFF} = 60$ V
	Capacity between terminals	C_{OFF}	---	130	---	pF	$V = 0$, $f = 1$ MHz
Capacity between I/O terminals		C_{I-O}	---	0.8	---	pF	$f = 1$ MHz, $V_s = 0$ V
Insulation resistance		R_{I-O}	1,000	---	---	$\text{M}\Omega$	$V_{I-O} = 500$ VDC, $R_{OH} \leq 60\%$
Turn-ON time		t_{ON}	---	0.8	2.0	ms	$I_F = 5$ mA, $R_L = 200$ Ω , $V_{DD} = 20$ V (See note 2.)
Turn-OFF time		t_{OFF}	---	0.1	0.5	ms	

Note: 2. Turn-ON and Turn-OFF Times

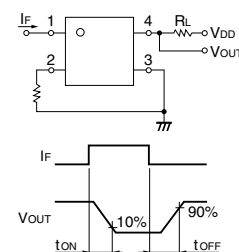

■ Recommended Operating Conditions

Use the G3VM under the following conditions so that the Relay will operate properly.

Item	Symbol	Minimum	Typical	Maximum	Unit
Load voltage (AC peak/DC)	V_{DD}	---	---	48	V
Operating LED forward current	I_F	5	7.5	25	mA
Continuous load current (AC peak/DC)	I_O	---	---	500	mA
Operating temperature	T_a	-20	---	65	$^\circ\text{C}$

■ Engineering Data

LED forward current vs. Ambient temperature

$I_F - T_a$

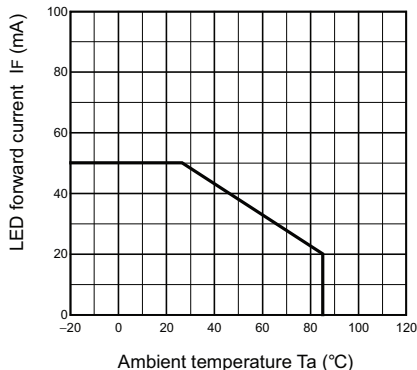

Continuous load current vs. Ambient temperature

$I_O - T_a$

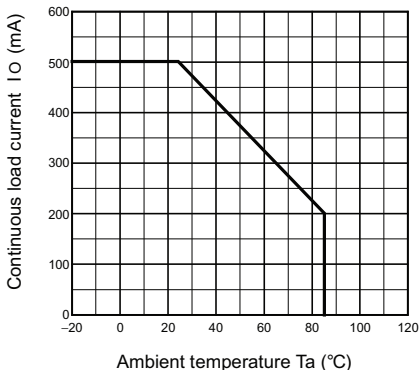

LED forward current vs. LED forward voltage

$I_F - V_F$

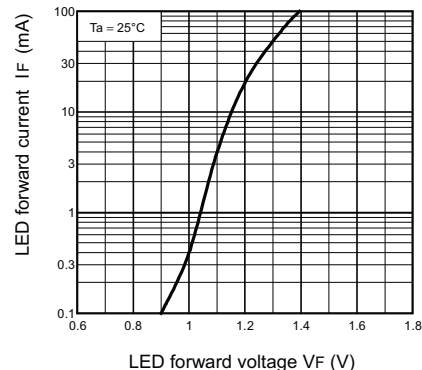

Continuous load current vs. On-state voltage

$I_O - V_{ON}$

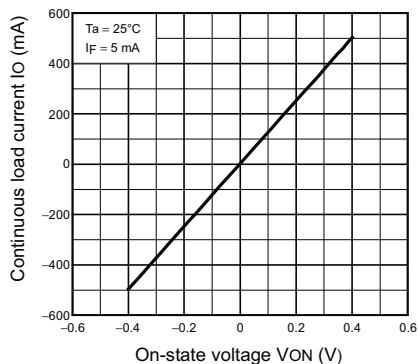

On-state resistance vs. Ambient temperature

$R_{ON} - T_a$

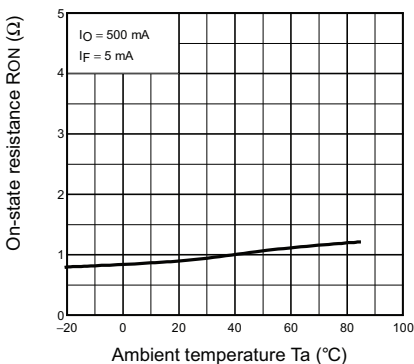

Trigger LED forward current vs. Ambient temperature

$I_{FT} - T_a$

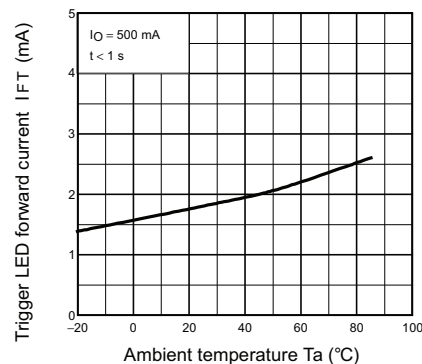

Turn ON, Turn OFF time vs. LED forward current

$t_{ON}, t_{OFF} - I_F$

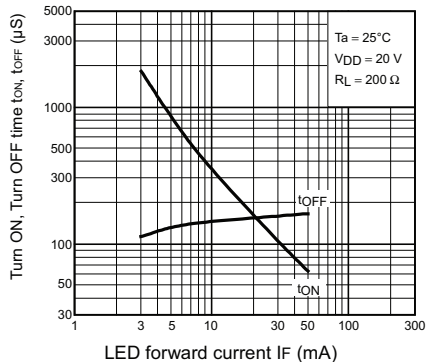

Turn ON, Turn OFF time vs. Ambient temperature

$t_{ON}, t_{OFF} - T_a$

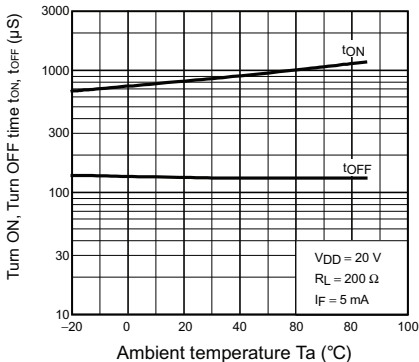

Current leakage vs. Ambient temperature

$I_{LEAK} - T_a$

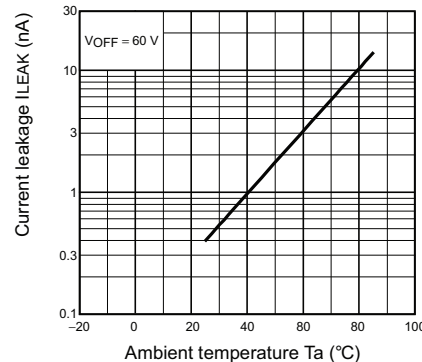

All sales are subject to Omron Electronic Components LLC standard terms and conditions of sale, which can be found at http://www.components.omron.com/components/web/webfiles.nsf/sales_terms.html

ALL DIMENSIONS SHOWN ARE IN MILLIMETERS.
To convert millimeters into inches, multiply by 0.03937. To convert grams into ounces, multiply by 0.03527.



OMRON ELECTRONIC COMPONENTS LLC
55 E. Commerce Drive, Suite B
Schaumburg, IL 60173

847-882-2288

OMRON ON-LINE

Global - <http://www.omron.com>
USA - <http://www.components.omron.com>

Cat. No. X302-E-1

12/10

Specifications subject to change without notice

Printed in USA