

0.5 mm-Pitch Rotary-Lock FPC Connector

XF2H

SMT ZIF (Zero Insertion Force)
Connector with Rotary-Lock
Improves Assembly Reliability,
Manufacturing Efficiency

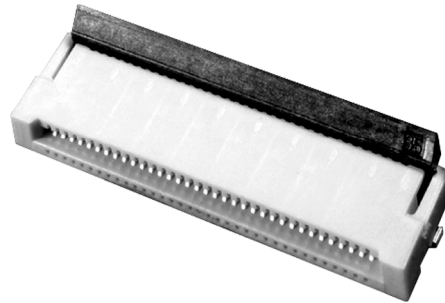

- Rotary-lock at rear instead of front simplifies assembly, provides secure connection even if cable flexes upward
- FPC housing design ensures reliable alignment of the circuits during assembly, unaffected by rotary-lock
- Double-sided contacts can be used wherever top or bottom connection is needed, reducing part numbers on the bill of materials
- Connector is supplied with rotary-lock in the open position, eliminating one step during assembly, improving productivity
- Low profile, measures only 2 mm max. above the circuit board
- Connectors supplied on tape reels for automatic insertion

Ordering Information

Circuits	Part number	Circuits	Part number	Quantity per reel
10	XF2H-1015-1	30	XF2H-3015-1	1,500 per reel Order in multiples of the quantity per reel.
12	XF2H-1215-1	32	XF2H-3215-1	
13	XF2H-1315-1	33	XF2H-3315-1	
14	XF2H-1415-1	34	XF2H-3415-1	
18	XF2H-1815-1	35	XF2H-3515-1	
20	XF2H-2015-1	36	XF2H-3615-1	
21	XF2H-2115-1	38	XF2H-3815-1	
22	XF2H-2215-1	40	XF2H-4015-1	
24	XF2H-2415-1	45	XF2H-4515-1	
26	XF2H-2615-1	50	XF2H-5015-1	

Note: Connectors with different circuit counts and contact locations are available on special order. Contact your Omron representative.

Specifications

Rated current	0.5 A
Rated voltage	50 VDC
Contact resistance	30 M Ω max. at 20 mVDC, 100 mA max.
Insulation resistance	100 M Ω min. at 250 VDC
Withstand voltage	250 VAC for 1 minute (with a leakage current of 1 mA max.)
Insertion tolerance	20 times
Ambient temperature	-30°C to 85°C (-22°F to 185°F); no condensation at low temperatures

■ MATERIALS/FINISH

Housing	PA46 resin (UL94V-0)/natural
Slide lock	LCP resin (UL94V-0)/black
Contact	Copper-alloy/nickel spring substrate (2 μ m) plated with tin alloy (2 μ m)
Hold-down	Copper-alloy/copper substrate (2 μ m) plated with tin alloy (2 μ m)

Dimensions

Unit: mm

XF2H-□□15-1

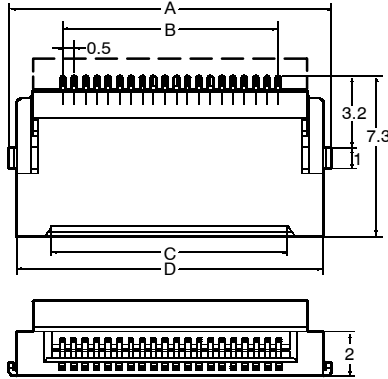
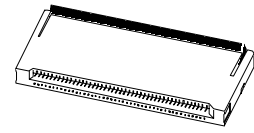

Applicable FPC Dimensions

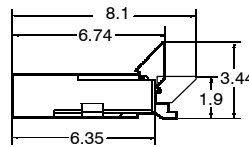
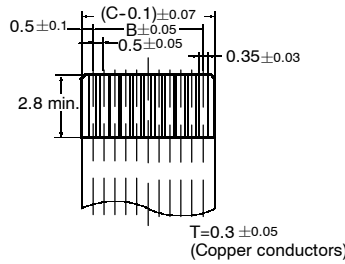

Printed Circuit Board Matching Dimensions (Top View)

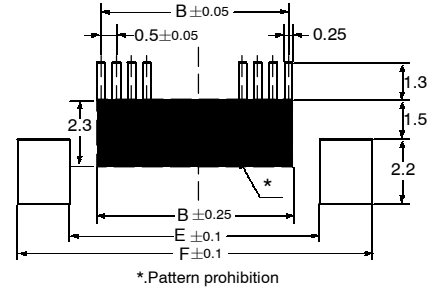
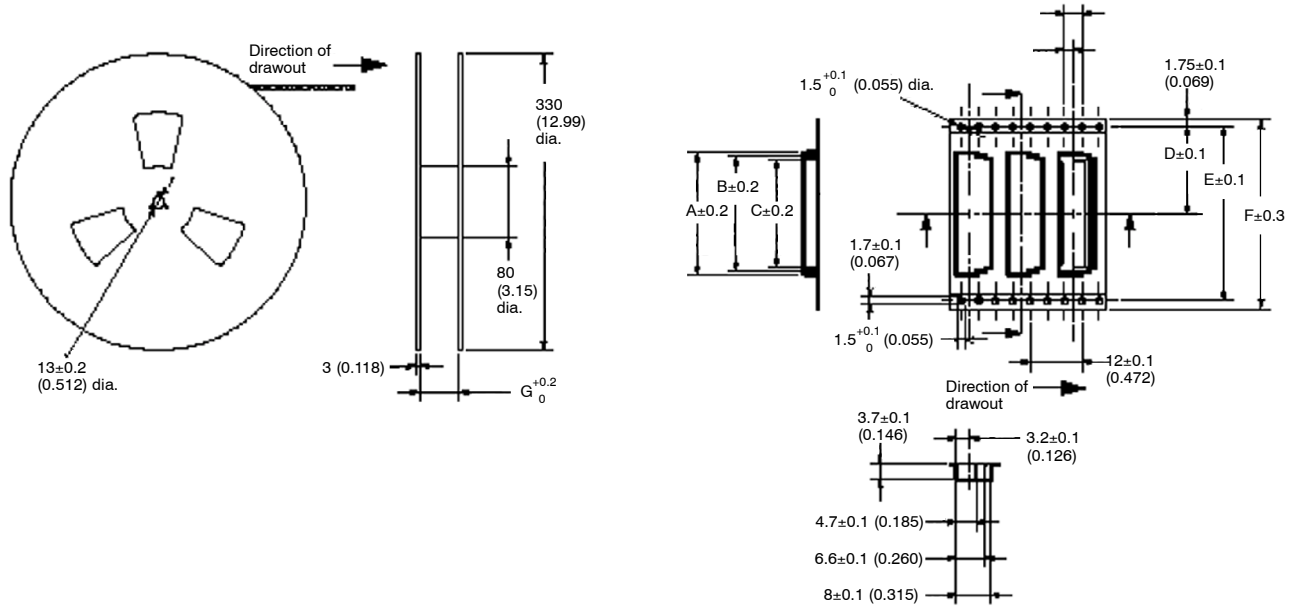

TABLE OF DIMENSIONS

Circuits	Part number	A	B	C	D	E	F
10	XF2H-1015-1	9.1 (0.36)	4.5 (0.18)	5.6 (0.22)	8.5 (0.33)	6.5 (0.26)	10.1 (0.40)
12	XF2H-1215-1	10.1 (0.39)	5.5 (0.22)	6.6 (0.26)	9.5 (0.37)	7.5 (0.29)	11.1 (0.44)
13	XF2H-1315-1	10.6 (0.42)	6.0 (0.24)	7.1 (0.28)	10.0 (0.39)	8.0 (0.31)	11.6 (0.46)
14	XF2H-1415-1	11.1 (0.44)	6.5 (0.26)	7.6 (0.30)	10.5 (0.41)	8.5 (0.33)	12.1 (0.48)
18	XF2H-1815-1	13.1 (0.52)	8.5 (0.33)	9.6 (0.38)	12.5 (0.49)	10.5 (0.41)	14.1 (0.56)
20	XF2H-2015-1	14.1 (0.56)	9.5 (0.37)	10.6 (0.42)	13.5 (0.53)	11.5 (0.45)	15.1 (0.59)
21	XF2H-2115-1	14.6 (0.57)	10.0 (0.39)	11.1 (0.44)	14.0 (0.55)	12.0 (0.47)	15.6 (0.61)
22	XF2H-2215-1	15.1 (0.59)	10.5 (0.41)	11.6 (0.46)	14.5 (0.57)	12.5 (0.49)	16.1 (0.63)
24	XF2H-2415-1	16.1 (0.63)	11.5 (0.45)	12.6 (0.50)	15.5 (0.61)	13.5 (0.53)	17.1 (0.67)
26	XF2H-2615-1	17.1 (0.67)	12.5 (0.49)	13.6 (0.53)	16.5 (0.65)	14.5 (0.57)	18.1 (0.71)
30	XF2H-3015-1	19.1 (0.75)	14.5 (0.57)	15.6 (0.61)	18.5 (0.73)	16.5 (0.65)	20.1 (0.79)
32	XF2H-3215-1	20.1 (0.79)	15.5 (0.61)	16.6 (0.65)	19.5 (0.77)	17.5 (0.69)	21.1 (0.83)
33	XF2H-3315-1	20.6 (0.81)	16.0 (0.63)	17.1 (0.67)	20.0 (0.79)	18.0 (0.71)	21.6 (0.85)
34	XF2H-3415-1	21.1 (0.83)	16.5 (0.65)	17.6 (0.69)	20.5 (0.81)	18.5 (0.73)	22.1 (0.87)
35	XF2H-3515-1	21.6 (0.85)	17.0 (0.67)	18.1 (0.71)	21.0 (0.83)	19.0 (0.75)	22.6 (0.89)
36	XF2H-3615-1	22.1 (0.87)	17.5 (0.69)	18.6 (0.73)	21.5 (0.85)	19.5 (0.77)	23.1 (0.91)
38	XF2H-3815-1	23.1 (0.91)	18.5 (0.73)	19.6 (0.77)	22.5 (0.89)	20.5 (0.81)	24.1 (0.95)
40	XF2H-4015-1	24.1 (0.95)	19.5 (0.77)	20.6 (0.81)	23.5 (0.92)	21.5 (0.85)	25.1 (0.99)
45	XF2H-4515-1	26.6 (1.05)	22.0 (0.87)	23.1 (0.91)	26.0 (1.02)	24.0 (0.94)	27.6 (1.09)
50	XF2H-5015-1	29.1 (1.15)	24.5 (0.96)	25.6 (1.01)	28.5 (1.12)	26.5 (1.04)	30.1 (1.19)

■ TAPE AND REEL DIMENSIONS



Circuits	Part number	A	B	C	D	E	F	G
10	XF2H-1015-1	10.2 (0.402)	8.7 (0.343)	7.4 (0.291)	11.5 (0.453)	—	24.0 (0.945)	24.4 (0.961)
12	XF2H-1215-1	11.2 (0.441)	9.7 (0.82)	8.4 (0.331)				
13	XF2H-1315-1	11.7 (0.461)	10.2 (0.402)	8.9 (0.350)				
14	XF2H-1415-1	12.2 (0.480)	10.7 (0.421)	9.4 (0.370)				
18	XF2H-1815-1	14.2 (0.559)	12.7 (0.5)	11.4 (0.449)				
20	XF2H-2015-1	15.2 (0.598)	13.7 (0.539)	12.4 (0.488)				
21	XF2H-2115-1	15.7 (0.618)	14.2 (0.559)	12.9 (0.508)				
22	XF2H-2215-1	16.2 (0.638)	14.7 (0.579)	13.4 (0.528)				
24	XF2H-2415-1	17.2 (0.677)	15.7 (0.618)	14.4 (0.567)				
26	XF2H-2615-1	18.2 (0.717)	16.7 (0.657)	15.4 (0.606)				
30	XF2H-3015-1	20.2 (0.795)	18.7 (0.736)	17.4 (0.685)				
32	XF2H-3215-1	21.2 (0.835)	19.7 (0.776)	18.4 (0.724)				
33	XF2H-3315-1	21.7 (0.854)	20.2 (0.795)	18.9 (0.744)				
34	XF2H-3415-1	22.2 (0.874)	20.7 (0.815)	19.4 (0.764)				
35	XF2H-3515-1	22.7 (0.894)	21.2 (0.835)	19.9 (0.783)	20.2 (0.795)	40.4 (1.591)	44.0 (1.732)	44.4 (1.748)
36	XF2H-3615-1	23.2 (0.913)	21.7 (0.854)	20.4 (0.803)				
38	XF2H-3815-1	24.2 (0.953)	22.7 (0.894)	21.4 (0.843)				
40	XF2H-4015-1	25.2 (0.992)	23.7 (0.933)	22.4 (0.882)				
45	XF2H-4515-1	27.7 (1.091)	26.2 (1.031)	24.9 (0.980)				
50	XF2H-5015-1	30.2 (1.189)	28.7 (1.130)	27.4 (1.079)				

Note: *For tape widths of 24 mm (dimension F), pilot holes are located on one side only.

Precautions

■ RECOMMENDED REFLOW CONDITIONS

Pre-heat

Temperature: $150 \pm 10^{\circ}\text{C}$

Time: 60 to 120 seconds

Soldering

Temperature: 200 to 240°C

Time: Not exceeding 30 seconds
(Not exceeding 10 seconds at 240°C
maximum temperature.)

■ STORAGE

Do not store under high humidity levels as this may cause deterioration of the insulation.

■ HANDLING THE FPC

Do not forcibly bend or pull an FPC which has been mounted and locked. This may cause discontinuities in the FPC.

NOTE: DIMENSIONS SHOWN ARE IN MILLIMETERS. To convert millimeters to inches divide by 25.4.

OMRON[®]

OMRON ELECTRONICS LLC

One East Commerce Drive
Schaumburg, IL 60173

1-800-55-OMRON

OMRON ON-LINE

Global - <http://www.omron.com>
USA - <http://www.omron.com/oei>
Canada - <http://www.omron.com/oci>

OMRON CANADA, INC.

885 Milner Avenue
Scarborough, Ontario M1B 5V8

416-286-6465