

Half-Pitch Connectors

XH2

Allows high-density mounting for electronic devices.

A half-pitch connector with a pitch of 1.27 mm (0.05 in.) for compactness.

- A pitch of 1.27 mm (0.05 in.) for high-density mounting of double-row arrangements.
- A quadruple-row staggered arrangement (1.27 mm x 1.905 mm) (0.05 in. x 0.075 in.) for board connection.
- The bellows contact design, enables smooth mating and resistance to bending.
- Space saving mating length of 3.1 mm (0.12 in.).
- Positive contact locking assures long-term contact quality. The gold/palladium plating has been improved for better contact reliability.
- A special finish prevents flux rise. Also, it has fastening pins to standardize all the terminals.

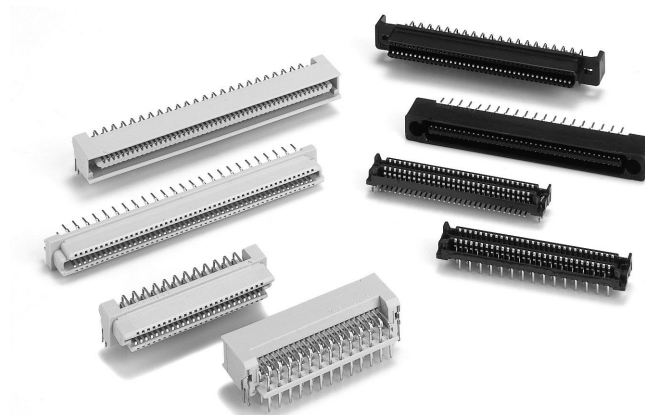

Ordering Information

See ordering tables on the following pages.

Specifications

Rated current	0.5 A (at 20°C)
Contact resistance*	30 mΩ max. (at 20 mV, 100 mA max.)
Insulation resistance	10 ³ mΩ min (at 500 VDC)
Withstand voltage	650 VAC for 1 min. (leakage current 1 mA max.)
Connector insertion	80 gf (0.18 lb.f) max. per contact
Connector removal	10 gf (0.022 lb.f) max. per contact
Usage durability	400 times min.
Operating temperature	-55 to 105°C

*For XH2A-□□42 and XH2B-□□41

Materials and Finish

Item		Plug	Socket
Housing		PBT resin with glass (UL94V-0) (black)	
Locator		PBT resin with glass (UL94V-0) (black)	
Contact	Mating end	Phosphor bronze/nickel base, gold/palladium plating	Phosphor bronze/nickel base/gold/palladium plating
	Terminal	Phosphor bronze/nickel base, copper plating (2mm)	Phosphor bronze/nickel base copper plating (2mm)
Fastening pins		Phosphor bronze/copper plating	

Mating Diagram

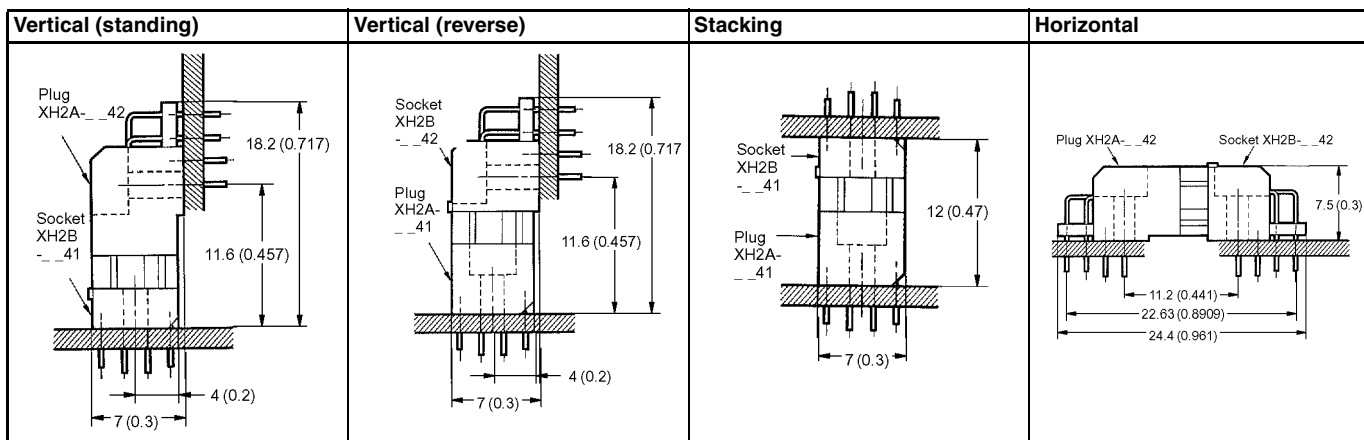

*The standard and reverse models function as the standard DIN connectors (XC5).

■ XH2A Plugs, Straight Dip Terminals

XH2A-□□41
(Straight dip terminals)

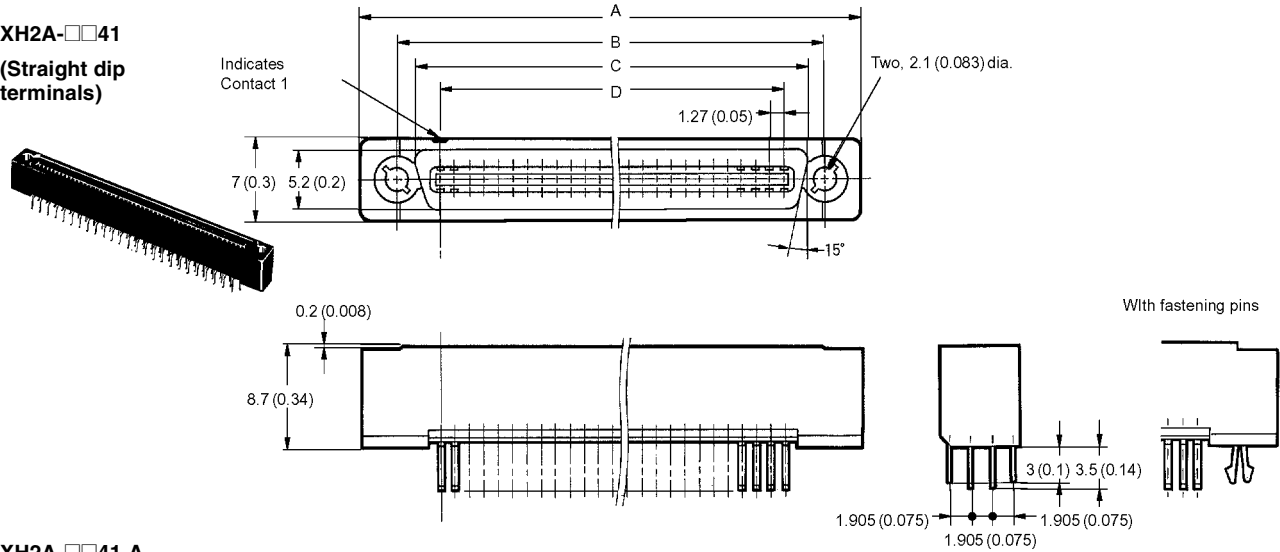

XH2A-□□41-A
(Straight dip terminals, with fastening pins)

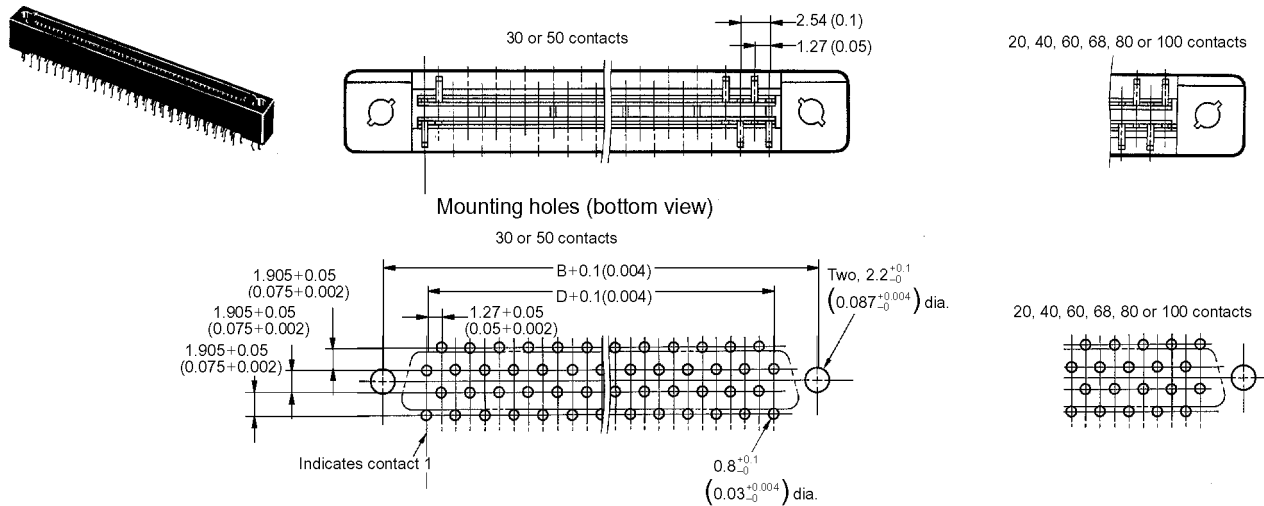

Ordering Information

No. of contacts	Dimensions [mm (in.)]				Model	
	A	B	C	D	Plug/straight dip terminals	Plug/straight dip terminals with fastening pins
20	25.4 (1)	19.05 (0.75)	15.8 (0.622)	11.43 (0.45)	XH2A-2041	XH2A-2041-A
30	31.8 (1.25)	25.40 (1)	22.2 (0.874)	17.78 (0.7)	XH2A-3041	XH2A-3041-A
40	38.1 (1.5)	31.75 (1.25)	28.5 (1.12)	24.13 (0.95)	XH2A-4041	XH2A-4041-A
50	44.5 (1.75)	38.10 (1.5)	34.9 (1.37)	30.48 (1.2)	XH2A-5041	XH2A-5041-A
60	50.8 (2)	45 (1.75)	41.2 (1.62)	36.83 (1.45)	XH2A-6041	XH2A-6041-A
68	55.9 (2.2)	49.53 (1.95)	46.3 (1.82)	41.91 (1.65)	XH2A-6841	XH2A-6841-A
80	63.5 (2.5)	57.15 (2.25)	53.9 (2.12)	49.53 (1.95)	XH2A-8041	XH2A-8041-A
100	76.2 (3)	69.85 (2.75)	66.6 (2.62)	62.23 (2.45)	XH2A-0141	XH2A-0141-A

■ XH2A Plugs, Right-angle Dip Terminals

XH2A-□□42

(Right-angle dip terminals)

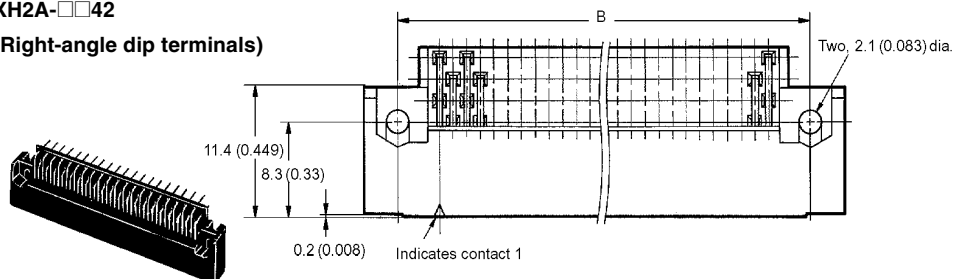

XH2A-□□42-A

(Right-angle dip terminals, with fastening pins)

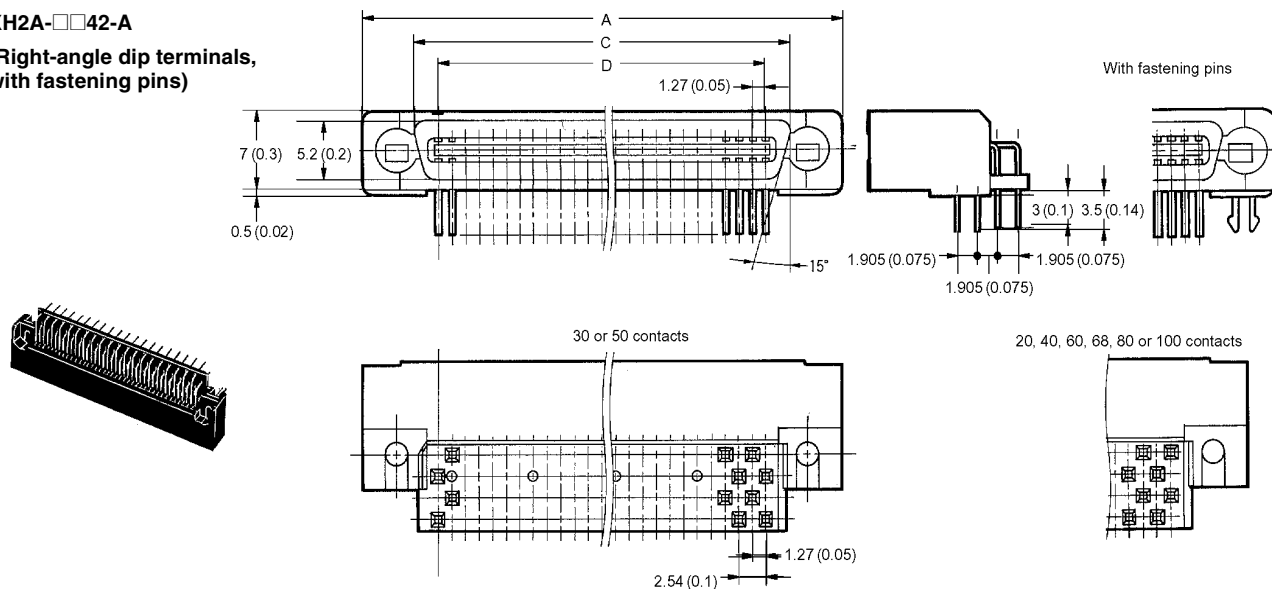

Mounting holes (bottom view)

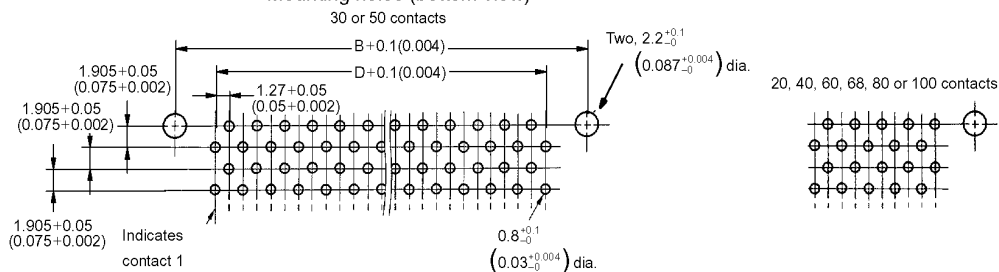

Ordering Information

No. of contacts	Dimensions [mm (in.)]				Model	
	A	B	C	D	Plug/straight dip terminals	Plug/straight dip terminals with fastening pins
20	25.4 (1)	19.05 (0.75)	15.8 (0.622)	11.43 (0.45)	XH2A-2042	XH2A-2042-A
30	31.8 (1.25)	25.40 (1)	22.2 (0.874)	17.78 (0.7)	XH2A-3042	XH2A-3042-A
40	38.1 (1.5)	31.75 (1.25)	28.5 (1.12)	24.13 (0.95)	XH2A-4042	XH2A-4042-A
50	44.5 (1.75)	38.10 (1.5)	34.9 (1.37)	30.48 (1.2)	XH2A-5042	XH2A-5042-A
60	50.8 (2)	44.45 (1.75)	41.2 (1.62)	36.83 (1.45)	XH2A-6042	XH2A-6042-A
68	55.9 (2.2)	49.53 (1.95)	46.3 (1.82)	41.91 (1.65)	XH2A-6842	XH2A-6842-A
80	63.5 (2.5)	57.15 (2.25)	53.9 (2.12)	49.53 (1.95)	XH2A-8042	XH2A-8042-A
100	76.2 (3)	69.85 (2.75)	66.6 (2.62)	62.23 (2.45)	XH2A-0142	XH2A-0142-A

■ XH2A Sockets, Straight Dip Terminals

XH2B-□□41
(Straight dip terminal)

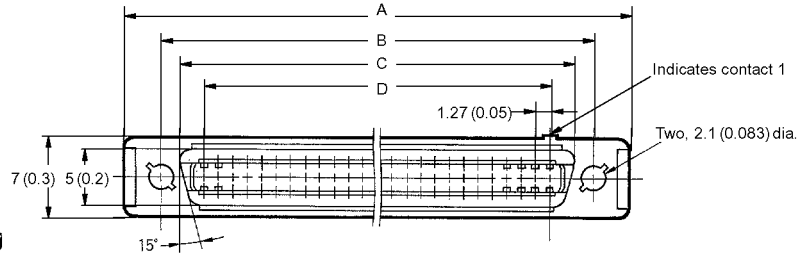
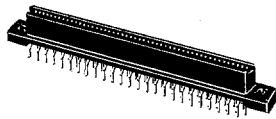

XH2B-□□41-A
(Straight dip terminal, with fastening pins)

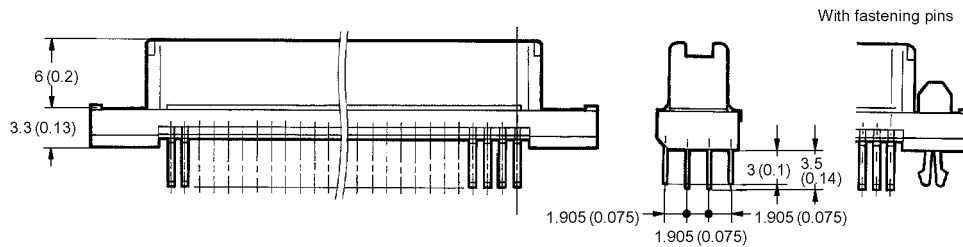
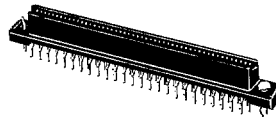

20, 40, 60, 68, 80 or 100 contacts

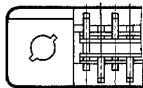

30 or 50 contacts

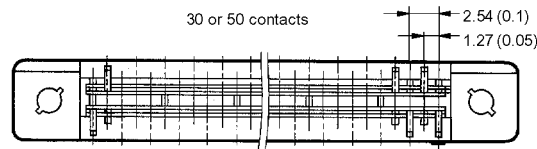

Mounting holes (bottom view)

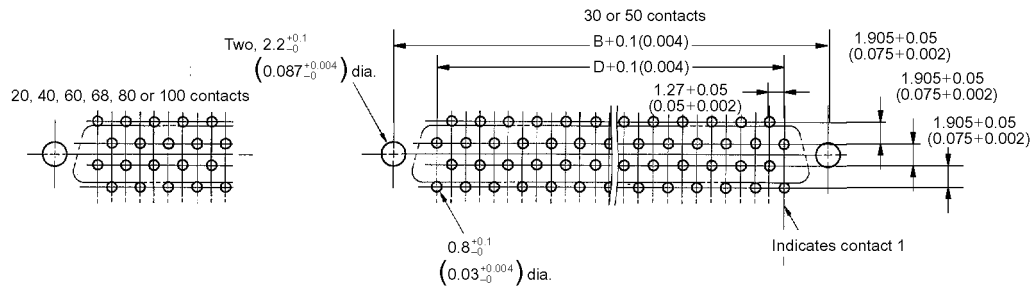

Ordering Information

No. of contacts	Dimensions [mm (in.)]				Model	
	A	B	C	D	Plug/straight dip terminals	Plug/straight dip terminals with fastening pins
20	25.4 (1)	19.05 (0.75)	15.7 (0.618)	11.43 (0.45)	XH2B-2041	XH2B-2041-A
30	31.8 (1.25)	25.40 (1)	22.1 (0.87)	17.78 (0.7)	XH2B-3041	XH2B-3041-A
40	38.1 (1.5)	31.75 (1.25)	28.4 (1.12)	24.13 (0.95)	XH2B-4041	XH2B-4041-A
50	44.5 (1.75)	38.10 (1.5)	34.8 (1.37)	30.48 (1.2)	XH2B-5041	XH2B-5041-A
60	50.8 (2)	44.45 (1.75)	41.1 (1.62)	36.83 (1.45)	XH2B-6041	XH2B-6041-A
68	55.9 (2.2)	49.53 (1.95)	46.2 (1.82)	41.91 (1.65)	XH2B-6841	XH2B-6841-A
80	63.5 (2.5)	57.15 (2.25)	53.8 (2.12)	49.53 (1.95)	XH2B-8041	XH2B-8041-A
100	76.2 (3)	69.85 (2.75)	66.5 (2.62)	62.23 (2.45)	XH2B-0141	XH2B-0141-A

■ XH2A Sockets, Right-angle Dip Terminals

XH2B-□□42

(Right-angle dip terminals)

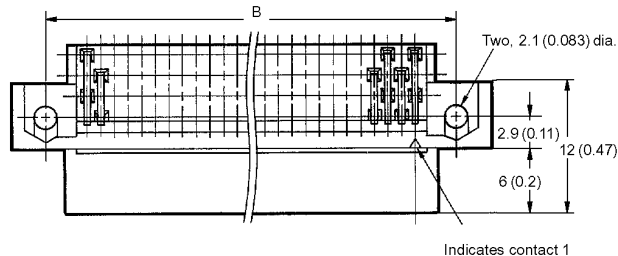
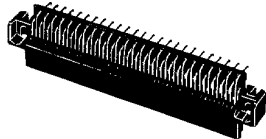

XH2B-□□42-A

(Right-angle dip terminals with fastening pins)

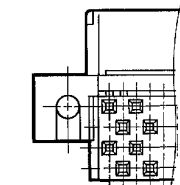
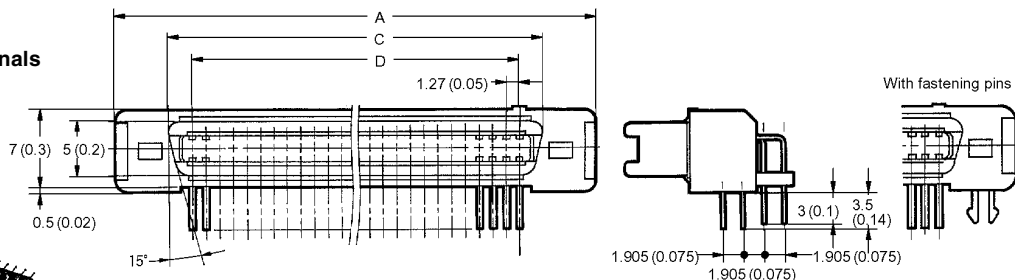
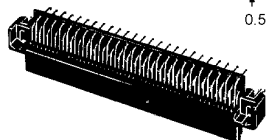

20, 40, 60, 68, 80, or 100 contacts

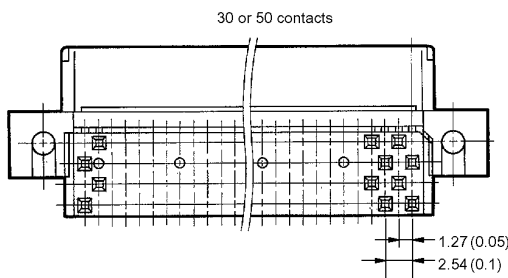

Mounting holes (bottom view)

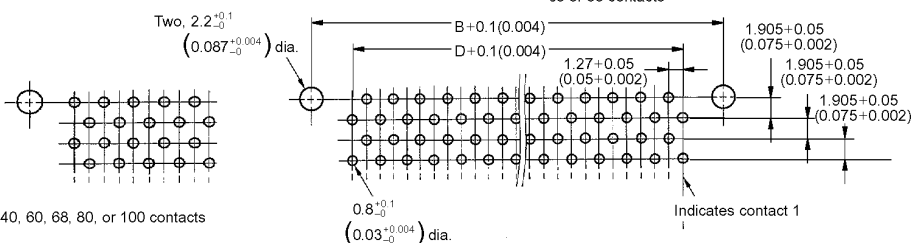

20, 40, 60, 68, 80, or 100 contacts

Ordering Information

No. of contacts	Dimensions [mm (in.)]				Model	
	A	B	C	D	Plug/straight dip terminals	Plug/straight dip terminals with fastening pins
20	25.4 (1)	19.05 (0.75)	15.7 (0.618)	11.43 (0.45)	XH2B-2042	XH2B-2042-A
30	31.8 (1.25)	25.40 (1)	22.1 (0.87)	17.78 (0.7)	XH2B-3042	XH2B-3042-A
40	38.1 (1.5)	31.75 (1.25)	28.4 (1.12)	24.13 (0.95)	XH2B-4042	XH2B-4042-A
50	44.5 (1.75)	38.10 (1.5)	34.8 (1.37)	30.48 (1.2)	XH2B-5042	XH2B-5042-A
60	50.8 (2)	44.45 (1.75)	41.1 (1.62)	36.83 (1.45)	XH2B-6042	XH2B-6042-A
68	55.9 (2.2)	49.53 (1.95)	46.2 (1.82)	41.91 (1.65)	XH2B-6842	XH2B-6842-A
80	63.5 (2.5)	57.15 (2.25)	53.8 (2.12)	49.53 (1.95)	XH2B-8042	XH2B-8042-A
100	76.2 (3)	69.85 (2.75)	66.5 (2.62)	62.23 (2.45)	XH2B-0142	XH2B-0142-A

General Information

■ Contact Numbers

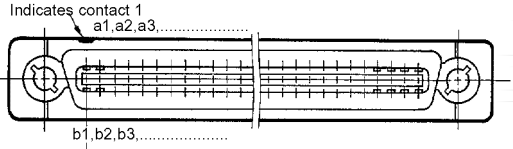
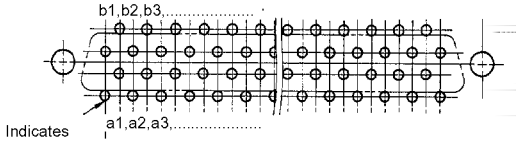
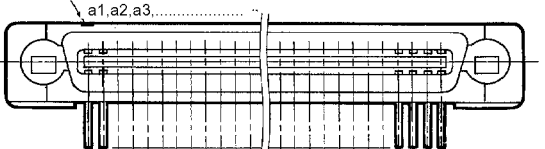
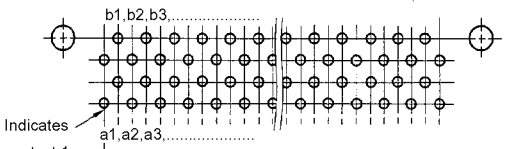
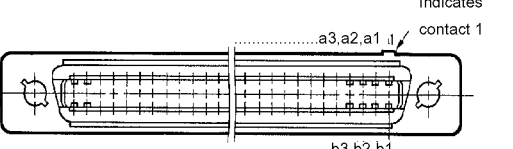
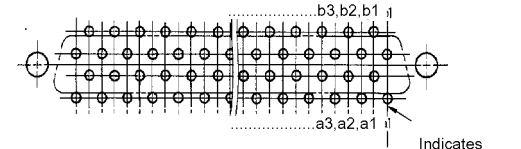
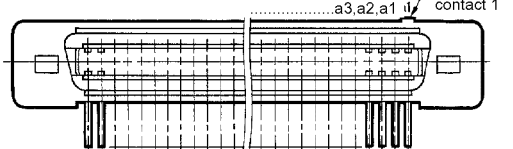
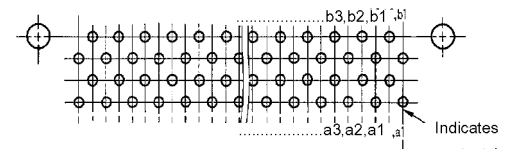
Terminal shape	Mated diagram	Mounting holes (bottom view)
Plug, straight terminals	 <p>Indicates contact 1 a1,a2,a3..... b1,b2,b3.....</p>	 <p>b1,b2,b3..... a1,a2,a3..... Indicates contact 1</p>
Plug, right-angle terminals	 <p>Indicates contact 1 a1,a2,a3..... b1,b2,b3.....</p>	 <p>b1,b2,b3..... a1,a2,a3..... Indicates contact 1</p>
Socket, straight terminals	 <p>Indicates contact 1a3,a2,a1b3,b2,b1</p>	 <p>.....b3,b2,b1a3,a2,a1 Indicates contact 1</p>
Socket, right-angle terminals	 <p>Indicates contact 1a3,a2,a1b3,b2,b1</p>	 <p>.....b3,b2,b1a3,a2,a1 Indicates contact 1</p>

- Contact numbers are not printed on the connectors. Use the triangular mark (indicates contact 1) as a guide when mounting to a board.
- On the mating side, the row terminals on the triangular mark side are called row a, and the other side is called row b. The numbers are in the order shown.
- The triangular marks on the plug and the socket should be aligned when mated. The contact numbers on both sides should match.

■ Precautions

Automated Soldering

Use tape to mask the right-angle connectors before automated-soldering.

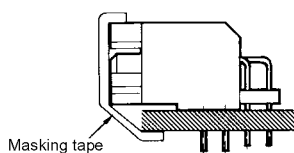

MEMO

A large grid of dashed lines for taking notes, consisting of 20 columns and 30 rows.

Terms and Conditions of Sale

1. **Offer; Acceptance.** These terms and conditions (these "Terms") are deemed part of all quotations, acknowledgments, invoices, purchase orders and other documents, whether electronic or in writing, relating to the sale of products or services (collectively, the "Products") by Omron Electronic Components LLC ("Seller"). Seller hereby objects to any terms or conditions proposed in Buyer's purchase order or other documents which are inconsistent with, or in addition to, these Terms.
2. **Prices; Payment.** All prices stated are current, subject to change without notice by Seller. Buyer agrees to pay the price in effect at time of shipment. Payments for Products received are due net 30 days unless otherwise stated in the invoice.
3. **Discounts.** Cash discounts, if any, will apply only on the net amount of invoices sent to Buyer after deducting transportation charges, taxes and duties, and will be allowed only if (i) the invoice is paid according to Seller's payment terms and (ii) Buyer has no past due amounts owing to Seller.
4. **Currencies.** If the prices quoted herein are in a currency other than U.S. dollars, Buyer shall make remittance to Seller at the then current exchange rate most favorable to Seller and which is available on the due date; provided that if remittance is not made when due, Buyer will convert the amount to U.S. dollars at the then current exchange rate most favorable to Seller available during the period between the due date and the date remittance is actually made.
5. **Governmental Approvals.** Buyer shall be responsible for, and shall bear all costs involved in, obtaining any government approvals required for the importation or sale of the Products.
6. **Taxes.** All taxes, duties and other governmental charges (other than general real property and income taxes), including any interest or penalties thereon, imposed directly or indirectly on Seller or required to be collected directly or indirectly by Seller for the manufacture, production, sale, delivery, importation, consumption or use of the Products sold hereunder (including customs duties and sales, excise, use, turnover and license taxes) shall be charged to and remitted by Buyer to Seller.
7. **Financial.** If the financial position of Buyer at any time becomes unsatisfactory to Seller, Seller reserves the right to stop shipments or require satisfactory security or payment in advance. If Buyer fails to make payment or otherwise comply with these Terms or any related agreement, Seller may (without liability and in addition to other remedies) cancel any unshipped portion of Products sold hereunder and stop any Products in transit until Buyer pays all amounts, including amounts payable hereunder, whether or not then due, which are owing to it by Buyer. Buyer shall in any event remain liable for all unpaid accounts.
8. **Cancellation; Etc.** Orders are not subject to rescheduling or cancellation unless Buyer indemnifies Seller fully against all costs or expenses arising in connection therewith.
9. **Force Majeure.** Seller shall not be liable for any delay or failure in delivery resulting from causes beyond its control, including earthquakes, fires, floods, strikes or other labor disputes, shortage of labor or materials, accidents to machinery, acts of sabotage, riots, delay in or lack of transportation or the requirements of any government authority.
10. **Shipping; Delivery.** Unless otherwise expressly agreed in writing by Seller:
 1. Shipments shall be by a carrier selected by Seller;
 2. Such carrier shall act as the agent of Buyer and delivery to such carrier shall constitute delivery to Buyer;
 3. All sales and shipments of Products shall be FOB shipping point (unless otherwise stated in writing by Seller), at which point title to and all risk of loss of the Products shall pass from Seller to Buyer, provided that Seller shall retain a security interest in the Products until the full purchase price is paid by Buyer;
 4. Delivery and shipping dates are estimates only.
 5. Seller will package Products as it deems proper for protection against normal handling and extra charges apply to special conditions.
11. **Claims.** Any claim by Buyer against Seller for shortage or damage to the Products occurring before delivery to the carrier must be presented in writing to Seller within 30 days of receipt of shipment and include the original transportation bill signed by the carrier noting that the carrier received the Products from Seller in the condition claimed.
12. **Warranties.** (a) **Exclusive Warranty.** Seller's exclusive warranty is that the Products will be free from defects in materials and workmanship for a period of twelve months from the date of sale by Seller (or such other period expressed in writing by Seller). Seller disclaims all other warranties, express or implied. (b) **Limitations.** SELLER MAKES NO WARRANTY OR REPRESENTATION, EXPRESS OR IMPLIED, ABOUT NON-INFRINGEMENT, MERCHANTABILITY OR FITNESS FOR A PARTICULAR PURPOSE OF THE PRODUCTS. BUYER ACKNOWLEDGES THAT IT ALONE HAS DETERMINED THAT THE PRODUCTS WILL SUITABLY MEET THE REQUIREMENTS OF THEIR INTENDED USE. Seller further disclaims all warranties and responsibility of any type for claims or expenses based on infringement by the Products or otherwise of any intellectual property right. (c) **Buyer Remedy.** Seller's sole obligation hereunder shall be to replace (in the form originally shipped with Buyer responsible for labor charges for removal or replacement thereof) the non-complying Product or, at Seller's election, to repay or credit Buyer an amount equal to the purchase price of the Product; provided that in no event shall Seller be responsible for warranty, repair, indemnity or any other claims or expenses regarding the Products unless Seller's analysis confirms that the Products were properly handled, stored, installed and maintained and not subject to contamination, abuse, misuse or inappropriate modification. Return of any Products by Buyer must be approved in writing by Seller before shipment. Seller shall not be liable for the suitability or unsuitability or the results from the use of Products in combination with any electrical or electronic components, circuits, system assemblies, or any other materials or substances or environments. Any advice, recommendations or information given orally or in writing are not to be construed as an amendment to the above warranty.
13. **Limitation on Liability; Etc.** SELLER SHALL NOT BE LIABLE FOR SPECIAL, INDIRECT, INCIDENTAL OR CONSEQUENTIAL DAMAGES, LOSS OF PROFITS OR PRODUCTION OR COMMERCIAL LOSS IN ANY WAY CONNECTED WITH THE PRODUCTS, WHETHER SUCH CLAIM IS BASED IN CONTRACT, WARRANTY, NEGLIGENCE OR STRICT LIABILITY. Further, in no event shall liability of Seller exceed the individual price of the Product on which liability is asserted.
14. **Indemnities.** Buyer shall indemnify and hold harmless Seller, its affiliates and its employees from and against all liabilities, losses, claims, costs and expenses (including attorney's fees and expenses) related to any claim, investigation, litigation or proceeding (whether or not Seller is a party) which arises or is alleged to arise from Buyer's acts or omissions under these Terms or in any way with respect to the Products. Without limiting the foregoing, Buyer (at its own expense) shall indemnify and hold harmless Seller and defend or settle any action brought against Seller to the extent that it is based on a claim that any Product made to Buyer specifications infringed intellectual property rights of another party.
15. **Property; Confidentiality.** The intellectual property embodied in the Products is the exclusive property of Seller and its affiliates and Buyer shall not attempt to duplicate it in any way without the written permission of Seller. Notwithstanding any charges to Buyer for engineering or tooling, all engineering and tooling supplied by Seller to Buyer relating to the Products are confidential and proprietary, and Buyer shall limit distribution thereof to its trusted employees and strictly prevent disclosure to any third party.
16. **Miscellaneous.** (a) **Waiver.** No failure or delay by Seller in exercising any right and no course of dealing between Buyer and Seller shall operate as a waiver of rights by Seller. (b) **Assignment.** Buyer may not assign its rights hereunder without Seller's written consent. (c) **Law.** These Terms are governed by Illinois law (without regard to conflict of law principles). Federal and state courts in Illinois shall have exclusive jurisdiction for any dispute hereunder. (d) **Amendment.** These Terms constitute the entire agreement between Buyer and Seller relating to the Products, and no provision may be changed or waived unless in writing signed by the parties. (e) **Severability.** If any provision hereof is rendered ineffective or invalid, such provision shall not invalidate any other provision. (f) **Setoff.** Buyer shall have no right to set off any amounts against the amount owing in respect of this invoice. (g) **Definitions.** As used herein, "including" means "including without limitation".

Certain Precautions on Specifications and Use

1. **Suitability for Use.** Seller shall not be responsible for conformity with any standards, codes or regulations which apply to the combination of the Product in Buyer's application or use of the Product. At Buyer's request, Seller will provide applicable third party certification documents identifying ratings and limitations of use which apply to the Product. This information by itself is not sufficient for a complete determination of the suitability of the Product in combination with the end product, machine, system, or other application or use. Buyer shall be solely responsible for determining appropriateness of the particular Product with respect to Buyer's application, product or system. Buyer shall take application responsibility in all cases but the following is a non-exhaustive list of applications for which particular attention must be given:
 - (i) Outdoor use, uses involving potential chemical contamination or electrical interference, or conditions or uses not described in this document.
 - (ii) Energy control systems, combustion systems, railroad systems, aviation systems, medical equipment, amusement machines, vehicles, safety equipment, and installations subject to separate industry or government regulations.
 - (iii) Use in consumer products or any use in significant quantities.
 - (iv) Systems, machines and equipment that could present a risk to life or property. Please know and observe all prohibitions of use applicable to this product.

NEVER USE THE PRODUCT FOR AN APPLICATION INVOLVING SERIOUS RISK TO LIFE OR PROPERTY WITHOUT ENSURING THAT THE SYSTEM AS A WHOLE HAS BEEN DESIGNED TO ADDRESS THE RISKS, AND THAT THE OMRON PRODUCT IS PROPERLY RATED AND INSTALLED FOR THE INTENDED USE WITHIN THE OVERALL EQUIPMENT OR SYSTEM.
2. **Programmable Products.** Seller shall not be responsible for the user's programming of a programmable product, or any consequence thereof.
3. **Performance Data.** Performance data given in this publication is provided as a guide for the user in determining suitability and does not constitute a warranty. It may represent the result of Seller's test conditions, and the users must correlate it to actual application requirements. Actual performance is subject to Seller's Warranty and Limitations of Liability.
4. **Change in Specifications.** Product specifications and accessories may be changed at any time based on improvements and other reasons. It is our practice to change part numbers when published ratings or features are changed or when significant construction changes are made. However, some specifications of the Product may be changed without any notice. When in doubt, special part numbers may be assigned to fix or establish key specifications for your application. Please consult with your Seller representative at any time to confirm actual specifications of purchased Product.
5. **Errors and Omissions.** The information in this publication has been carefully checked and is believed to be accurate; however, no responsibility is assumed for clerical, typographical or proofreading errors, or omissions.
6. **RoHS Compliance.** Where indicated, our products currently comply, to the best of our knowledge as of the date of this publication, with the requirements of the European Union's Directive on the Restriction of certain Hazardous Substances ("RoHS"), although the requirements of RoHS do not take effect until July 2006. These requirements may be subject to change. Please consult our website for current information.

Complete "Terms and Conditions of Sale" for product purchase and use are on Omron's website at www.components.omron.com – under the "About Us" tab, in the Legal Matters section.

ALL DIMENSIONS SHOWN ARE IN MILLIMETERS.

To convert millimeters into inches, multiply by 0.03937. To convert grams into ounces, multiply by 0.03527.

OMRON®

**OMRON ELECTRONIC
COMPONENTS LLC**

55 E. Commerce Drive, Suite B
Schaumburg, IL 60173

847-882-2288

OMRON CANADA, INC.

885 Milner Avenue
Toronto, Ontario M1B 5V8

416-286-6465

OMRON ON-LINE

Global - <http://www.omron.com>

USA - <http://www.components.omron.com>

Canada - <http://www.omron.ca>