

Surface Mount Detection Switch D3SK

The smallest detection switch in the industry (OMRON's data as of April 2008.)

- Ultra small size and ultra low profile contributing to down-sizing of sets devices. (3.0 x 3.5 x 0.9 mm (W x D x H))
- A unique mechanism enables high contact reliability and high precision operation.
- Long stroke for easy installation is available.
- Meet a variety of applications by contact and lever variations.

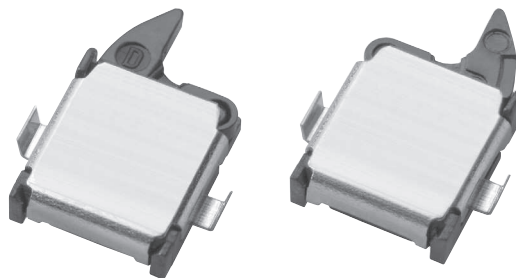

NEW

Ordering Information

Contact form	Direction of Operation		Positioning Boss	Model	Packing form
SPST-NO	Right		With Boss	D3SK-A1R	Embossed tape packing (see note)
			Without Boss	D3SK-A0R	
	Left		With Boss	D3SK-A1L	
			Without Boss	D3SK-A0L	
SPST-NC	Right		With Boss	D3SK-B1R	
			Without Boss	D3SK-B0R	
	Left		With Boss	D3SK-B1L	
			Without Boss	D3SK-B0L	

Note: The minimum packaging unit of the above models is 1,000 pieces per reel. Add "-6" to the end of the part number to obtain packaging quantities of 6,000 pieces per reel. eg: D3SK-B1R-6.

Model Number Legend

D3SK -
 1 2 3

1. **Contact Form**
A: SPST-NO
B: SPST-NC

2. **Boss for PCB Positioning**
0: without Boss
1: with Boss

3. **Lever and Detection Operation**
R: Right Operating with lever
L: Left Operating with lever

Specifications

■ Characteristics

Electrical Rating (see note 3)	1 mA at 5 VDC (resistive)
Operating speed	1 mm to 300 mm/s
Operating frequency	Mechanical: 20 operations/minute max. Electrical: 20 operations/minute max.
Insulation resistance	100 MΩ min. (at 100 VDC)
Contact resistance	3 Ω max.
Dielectric strength	100 VAC for 1 min between terminals of same polarity
Vibration resistance (see note 2)	Malfuction: 10 to 55 Hz, 1.5-mm double amplitude
Shock resistance (see note 2)	Destruction: 1000 m/s ² (approx. 100 G) max. Malfuction: 300 m/s ² (approx. 30 G) max.
Life expectancy	Mechanical: 150,000 operations min. (20 operations/minute) Electrical: 100,000 operations min. (20 operations/minute)
Ambient operating temperature	-25°C to 85°C (at 60% RH max.) with no icing or condensation
Ambient operating humidity	85% max. (for 5°C to 35°C)
Weight	Approx. 0.02 g

- Note:** 1. The data given above are initial values.
 2. The values apply at the total travel position. Contact opening or closing time is within 1ms.
 3. The electrical rating applies under the following test conditions:
 Ambient Temperature = 20±2°C, Ambient Humidity = 65±5%, Operating frequency = 30 operations/minute

■ Contact Specifications

Contact Specification	Slide
Minimum applicable load	15 μA at 3 VDC

Engineering Data

■ Contact form

SPST-NO

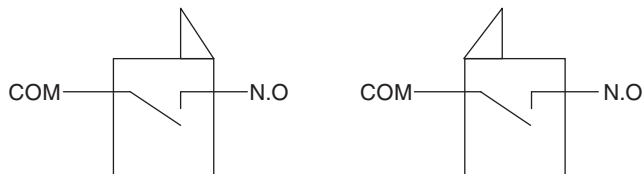

SPST-NC

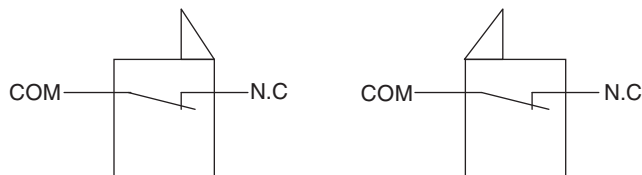

Note: The cover connects with COM terminal inside.

■ Packaging Specifications

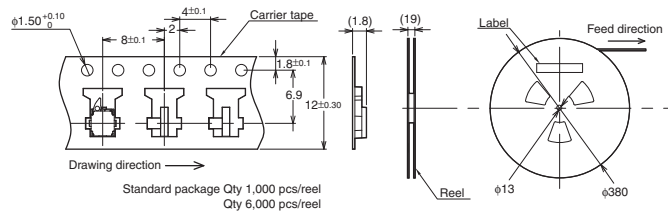

Standards	Conforms to JEITA
Package	Qty 1,000 pcs/reel Qty 6,000 pcs/reel

Dimensions and Operating Characteristics

Note: 1. Unless otherwise specified, all units are in millimeters and a tolerance of ± 0.15 mm applies to all dimensions
 2. The operating characteristics are for operation in the A direction (\downarrow) and B direction (\rightarrow , \leftarrow).

Right operating - without Boss D3SK-□0R

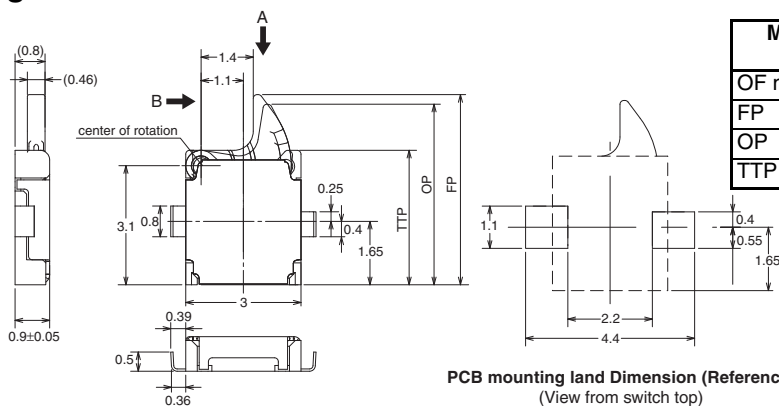
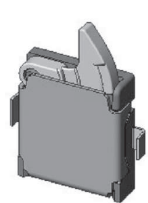

All Standard Models

Model	D3SK-□□R D3SK-□□L
OF max.	41 gf
FP	4.95 ± 0.15 mm
OP	4.7 ± 0.2 mm
TTP	3.5 ± 0.2 mm

Left operating - without Boss D3SK-□0L

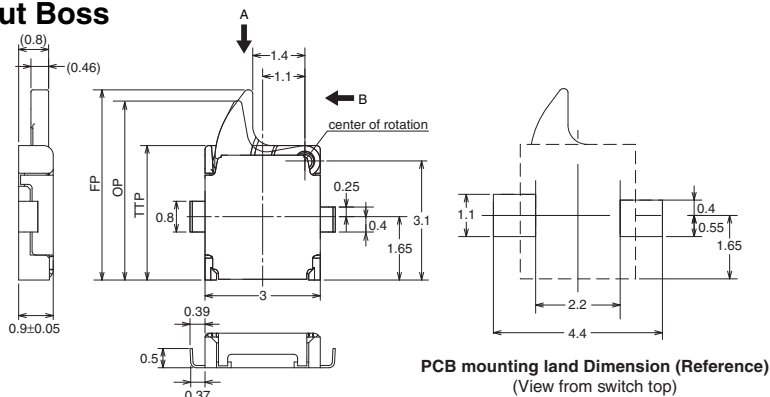
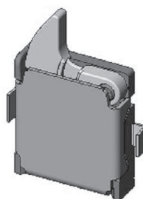

Right operating - with Boss D3SK-□1R

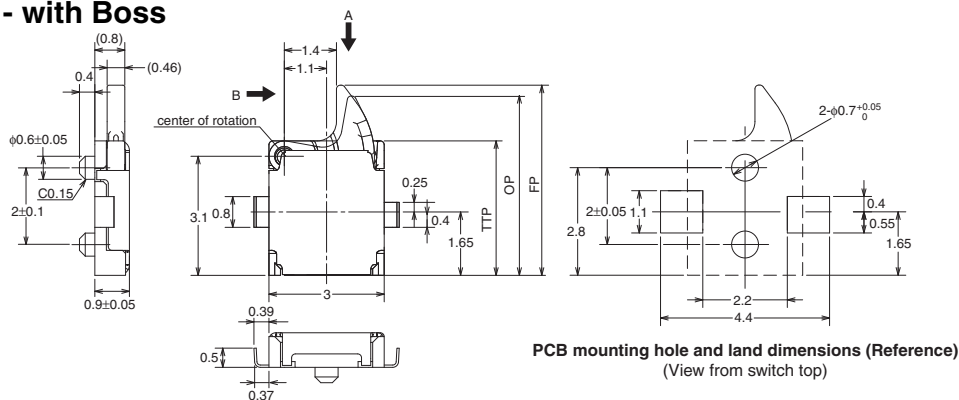
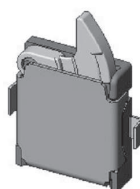

Left operating - with Boss D3SK-□1L

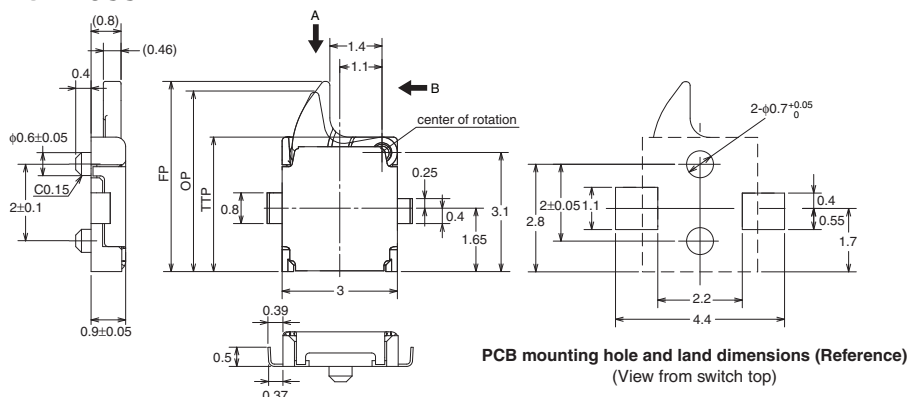
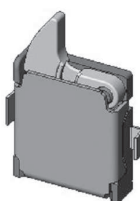

Precautions

Be sure to read the precautions and information common to all Snap Action and Detection Switches, contained in the Technical User's Guide, "Snap Action Switches, Technical Information" for correct use.

■ Correct Use

Mounting

The cover has the same electrical potential as the COM terminal. Do not short-circuit the cover with a NO or NC terminal when mounting the cover.

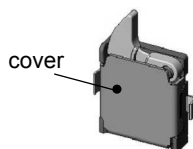

Be careful of the following points. Incorrect handling may lead to insufficient actuator return, Switch damage, or reduced durability.

- Set the operating body in line with the direction of the actuator movement, and make sure that the operating body is completely separate from the actuator when the Switch is in the free position (FP). When the actuator is operated from the crosswise direction of the Switch, make sure that the corner of the operating body has a minimum radius of R1.

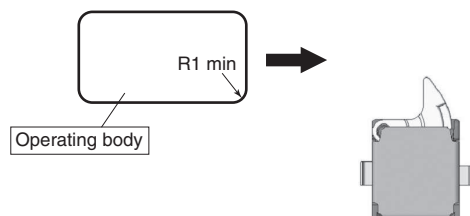

- Set the Switch stroke to 70% to 100% of the overtravel (the difference between the operating position and the total travel position).
- Do not subject the Switch to operations that involve strong impact.
- Do not use the Switch as a stopper.
- Do not apply excessive loads to the cover or operate the actuator from a direction other than a specified operating direction.
- Do not use an adhesive to secure the Switch.

A lubricant is used in the Switch. Some of the lubricant may seep out because the Switch does not have an airtight construction. Consider this possibility with respect to the usage conditions when designing or using the Switch.

Application Environment

Do not use the Switch in locations that are subject to toxic gas, silicon, excessive dust, excessive dirt, high temperatures, high humidity, sudden temperature changes, water splashes, or oil splashes. Otherwise, damage resulting by faulty contact of the Switch contacts, corrosion, or other causes, or other functional faults may occur.

Insulation and Wiring

Be sure that the installation conditions provide a sufficient insulation distance between Switch terminals and other metal parts, lands, etc.

Cleaning

The Switch does not have an airtight construction, and it must not be cleaned with cleaning fluids. Malfunctions may occur if the cleaning fluid penetrates the interior of the Switch together with flux or foreign matter from the surface of the PCB.

Confirmation with Actual Equipment

Be sure to confirm the quality of the product under the load and environmental conditions that will be used during actual applications.

■ Caution

Electrical Ratings

Confirm the contact load in order to select an appropriate switch rating.

Do not apply an excessive electrical load to the contacts, otherwise the contacts may weld, resulting in a short circuit or burning.

Terminal Connection

Do not use flow soldering or hand soldering to solder terminals.

Conduct reflow soldering within the range shown in the terminal temperature profile below. Some reflow soldering devices have extremely high peak values. Do a test in advance to confirm proper soldering conditions.

Do not conduct reflow soldering more than twice. Also provide a time interval of at least five minutes between the first and second reflow soldering processes to allow the Switch to return to room temperature. Heating the Switch continuously (without an interval) may cause the edges of the Switch to melt and degrade the characteristics.

When printing for a cream solder process, a 0.13-mm screen thickness is recommended.

Be sure to provide local ventilation.

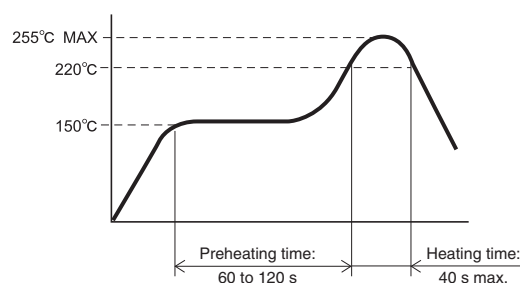

Printed Circuit Boards

Special attention must be paid to the handling of printed circuit boards after a Switch has been mounted onto them. Airborne PCB particles may penetrate the interior of the Switch when printed circuit boards are separated by cutting. Also, do not stack printed circuit boards that have Switches mounted on them.

Product Specification Details

This document provides only a partial list of specifications. It is recommended that you request complete drawings and specifications prior to purchasing or using the product.

■ RoHS Directive Compliance

Models that are indicated as being RoHS compliant are free of the following six substances.

Lead:	1,000 ppm max.
Mercury:	1,000 ppm max.
Cadmium:	100 ppm max.
Hexavalent chromium:	1,000 ppm max.
PBB:	1,000 ppm max.
PBDE:	1,000 ppm max.

A large grid of 20 columns and 30 rows of small squares, intended for taking notes or drawing. The grid is composed of thin, light gray lines forming a uniform pattern across the page.

All sales are subject to Omron Electronic Components LLC standard terms and conditions of sale, which can be found at http://www.components.omron.com/components/web/webfiles.nsf/sales_terms.html

ALL DIMENSIONS SHOWN ARE IN MILLIMETERS.

To convert millimeters into inches, multiply by 0.03937. To convert grams into ounces, multiply by 0.03527.

OMRON[®]

**OMRON ELECTRONIC
COMPONENTS LLC**

55 E. Commerce Drive, Suite B
Schaumburg, IL 60173

847-882-2288

OMRON ON-LINE

Global - <http://www.omron.com>

USA - <http://www.components.omron.com>