

Photomicrosensor (Actuator Mounted) EE-SA104

■ Dimensions

Note: All units are in millimeters unless otherwise indicated.

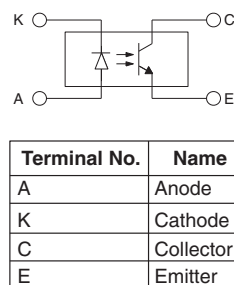
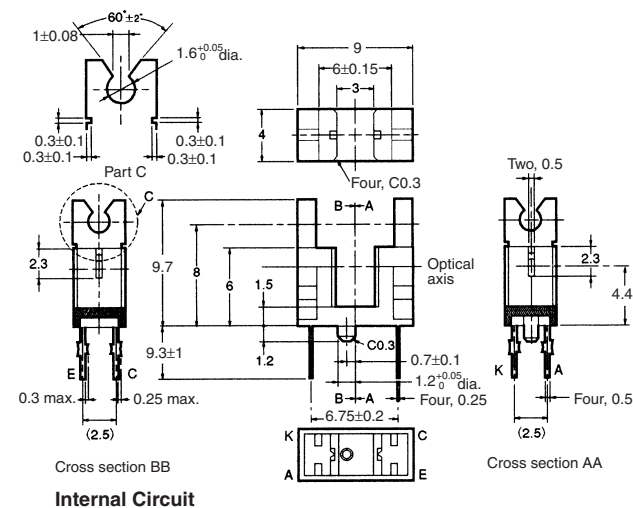

Unless otherwise specified, the tolerances are as shown below.

| Dimensions | Tolerance |
|--------------|-----------|
| 3 mm max. | ±0.3 |
| 3 < mm ≤ 6 | ±0.375 |
| 6 < mm ≤ 10 | ±0.45 |
| 10 < mm ≤ 18 | ±0.55 |
| 18 < mm ≤ 30 | ±0.65 |

■ Features

- An actuator can be attached.
- PCB mounting type.
- High resolution with a 0.5-mm-wide aperture.
- RoHS Compliant.

■ Absolute Maximum Ratings (Ta = 25°C)

| Item | Symbol | Rated value |
|-----------------------|------------------------------|---------------------------|
| Emitter | Forward current | I_F 50 mA (see note 1) |
| | Pulse forward current | I_{FP} 1 A (see note 2) |
| | Reverse voltage | V_R 4 V |
| Detector | Collector–Emitter voltage | V_{CEO} 30 V |
| | Emitter–Collector voltage | V_{ECO} --- |
| | Collector current | I_C 20 mA |
| | Collector dissipation | P_C 100 mW (see note 1) |
| Ambient temperature | Operating | T_{opr} -25°C to 85°C |
| | Storage | T_{stg} -30°C to 100°C |
| Soldering temperature | T_{sol} 260°C (see note 3) | |

- Note: 1. Refer to the temperature rating chart if the ambient temperature exceeds 25°C.
 2. The pulse width is 10 μs maximum with a frequency of 100 Hz.
 3. Complete soldering within 10 seconds.

■ Ordering Information

| Description | Model |
|-------------------------------------|----------|
| Photomicrosensor (actuator mounted) | EE-SA104 |

■ Electrical and Optical Characteristics (Ta = 25°C)

| Item | Symbol | Value | Condition |
|--------------|--------------------------------------|---|--------------------------------|
| Emitter | Forward voltage | V_F 1.2 V typ., 1.5 V max. | $I_F = 30$ mA |
| | Reverse current | I_R 0.01 μA typ., 10 μA max. | $V_R = 4$ V |
| | Peak emission wavelength | λ_P 940 nm typ. | $I_F = 20$ mA |
| Detector | Light current | I_L 0.5 mA min., 14 mA max. | $I_F = 20$ mA, $V_{CE} = 10$ V |
| | Dark current | I_D 2 nA typ., 200 nA max. | $V_{CE} = 10$ V, 0 lx |
| | Leakage current | I_{LEAK} --- | --- |
| | Collector–Emitter saturated voltage | $V_{CE(sat)}$ 0.1 V typ., 0.4 V max. | $I_F = 20$ mA, $I_L = 0.1$ mA |
| | Peak spectral sensitivity wavelength | λ_P 850 nm typ. | $V_{CE} = 10$ V |
| Rising time | t_r 4 μs typ. | $V_{CC} = 5$ V, $R_L = 100 \Omega$, $I_L = 5$ mA | |
| Falling time | t_f 4 μs typ. | $V_{CC} = 5$ V, $R_L = 100 \Omega$, $I_L = 5$ mA | |

■ Engineering Data

Forward Current vs. Collector Dissipation Temperature Rating

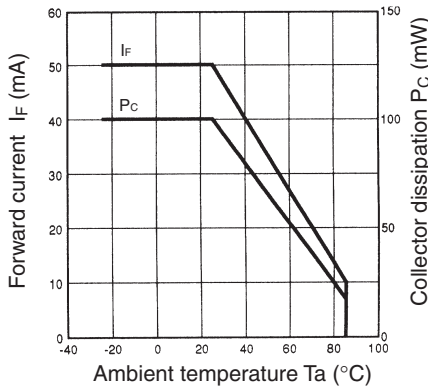

Forward Current vs. Forward Voltage Characteristics (Typical)

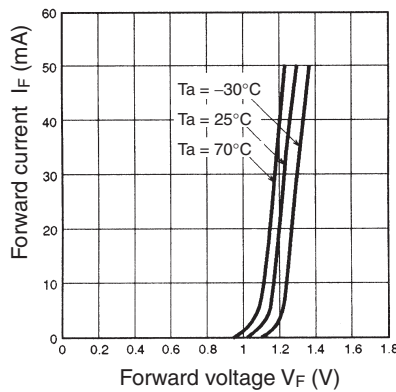

Light Current vs. Forward Current Characteristics (Typical)

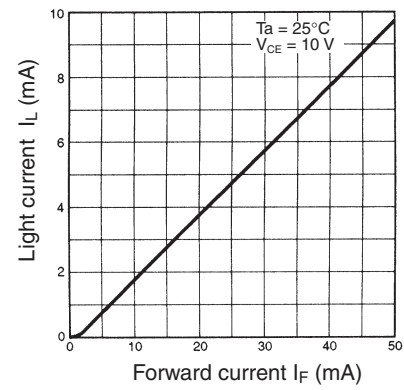

Light Current vs. Collector–Emitter Voltage Characteristics (Typical)

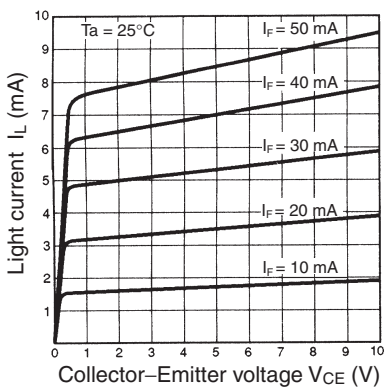

Relative Light Current vs. Ambient Temperature Characteristics (Typical)

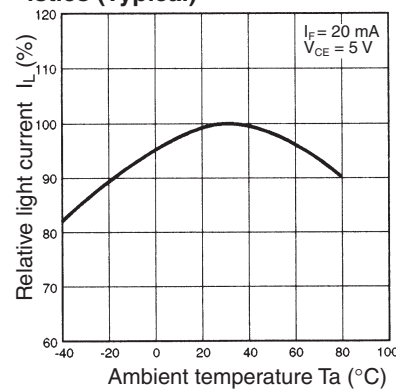

Dark Current vs. Ambient Temperature Characteristics (Typical)

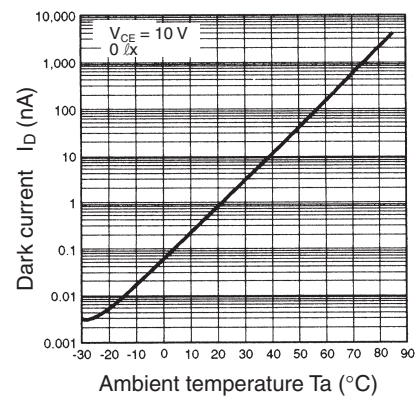

Response Time vs. Load Resistance Characteristics (Typical)

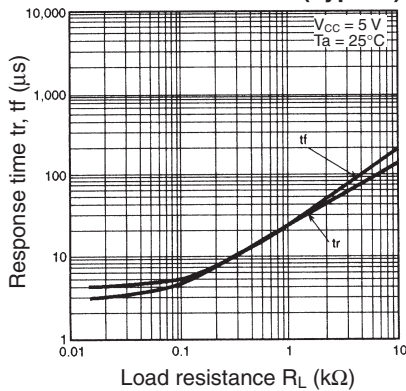

Sensing Position Characteristics (Typical)

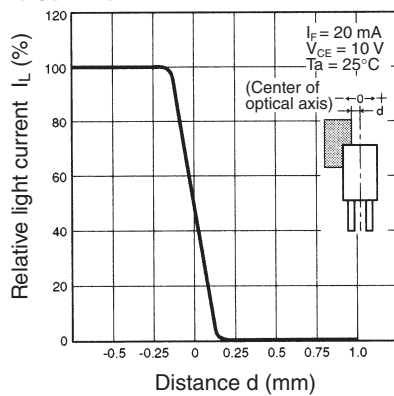

Sensing Position Characteristics (Typical)

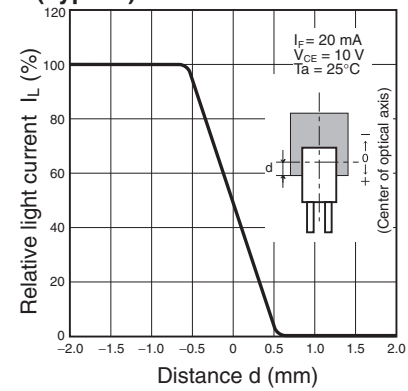

Response Time Measurement Circuit

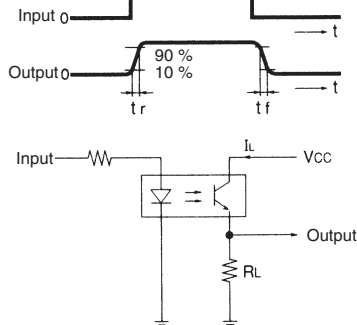

Actuator Dimensions

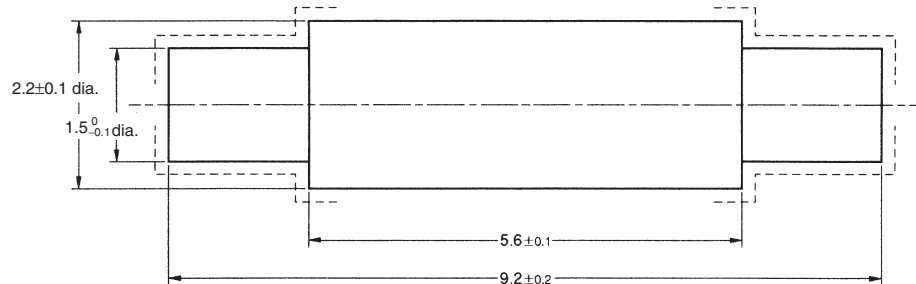

Note: 1. Make sure that the portions marked with dotted lines have no burrs.
2. The material of the actuator must be selected by considering the infrared permeability of the actuator.

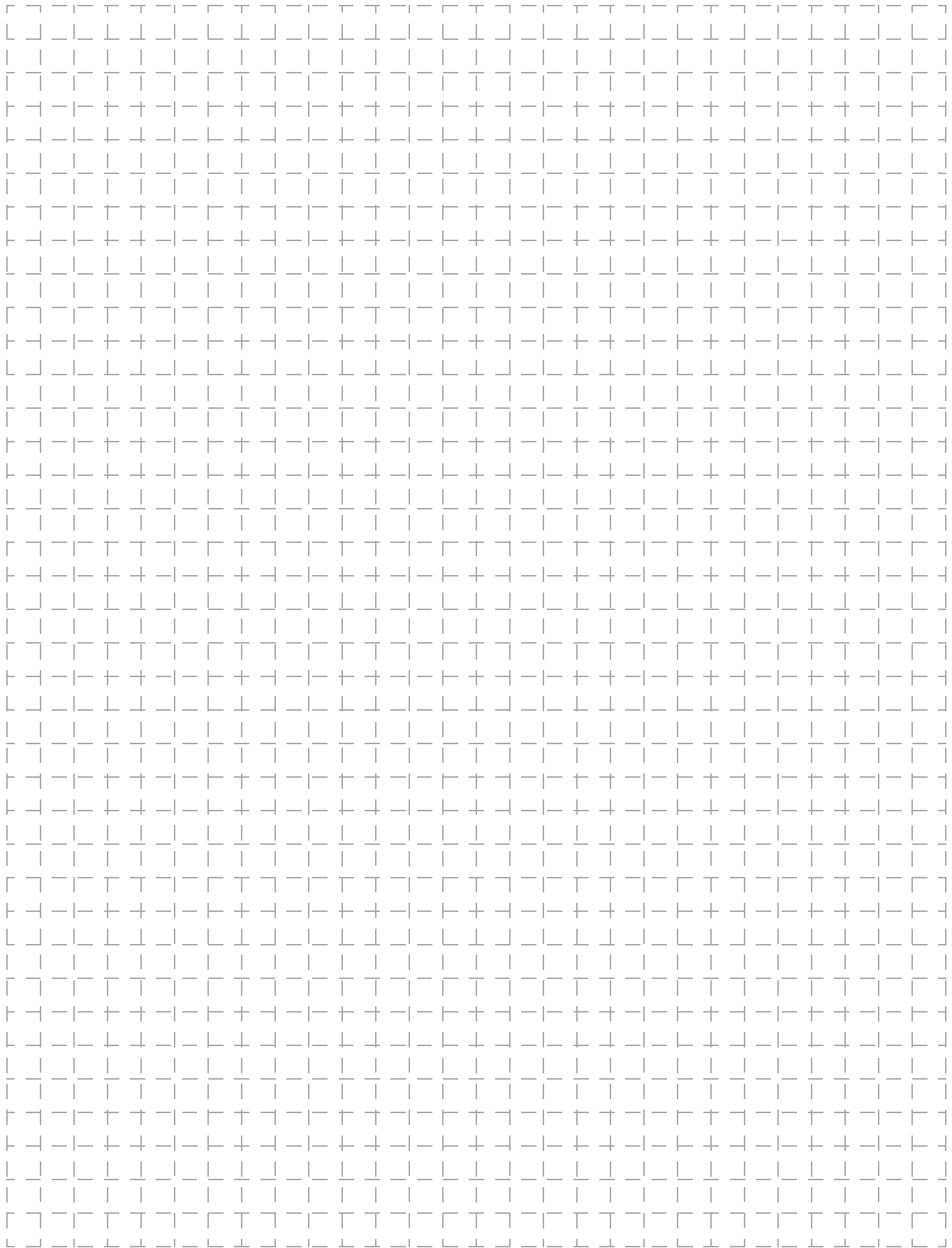

All sales are subject to Omron Electronic Components LLC standard terms and conditions of sale, which can be found at http://www.components.omron.com/components/web/webfiles.nsf/sales_terms.html

ALL DIMENSIONS SHOWN ARE IN MILLIMETERS.
To convert millimeters into inches, multiply by 0.03937. To convert grams into ounces, multiply by 0.03527.

OMRON[®]

**OMRON ELECTRONIC
COMPONENTS LLC**

55 E. Commerce Drive, Suite B
Schaumburg, IL 60173

847-882-2288

OMRON ON-LINE

Global - <http://www.omron.com>

USA - <http://www.components.omron.com>