

Photomicrosensor (Transmissive) EE-SX1131

■ Dimensions

Note: All units are in millimeters unless otherwise indicated.

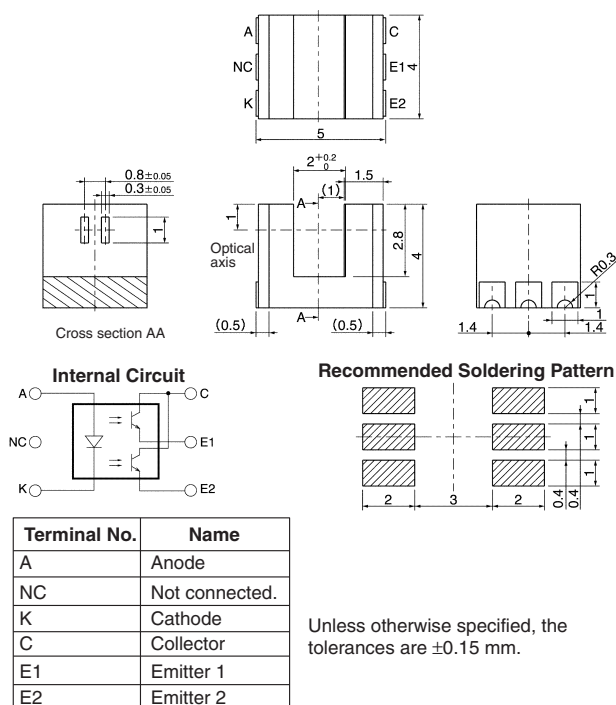

■ Features

- Ultra-compact with a 5-mm-wide sensor and a 2-mm-wide slot.
- PCB surface mounting type.
- High resolution with a 0.3-mm-wide aperture.
- Dual-channel output.
- RoHS Compliant.

■ Absolute Maximum Ratings (Ta = 25°C)

Item	Symbol	Rated value
Emitter	Forward current	I_F 25 mA (see note 1)
	Pulse forward current	I_{FP} 100 mA (see note 2)
	Reverse voltage	V_R 5 V
Detector	Collector–Emitter voltage	V_{CEO} 20 V
	Emitter–Collector voltage	V_{ECO} 5 V
	Collector current	I_C 20 mA
	Collector dissipation	P_C 75 mW (see note 1)
Ambient temperature	Operating	T_{opr} -30°C to 85°C
	Storage	T_{stg} -40°C to 90°C
	Reflow soldering	T_{sol} 255°C (see note 3)
	Manual soldering	T_{sol} 350°C (see note 3)

- Note: 1. Refer to the temperature rating chart if the ambient temperature exceeds 25°C .
 2. Duty: 1/100; Pulse width: 0.1 ms
 3. Complete soldering within 10 seconds for reflow soldering and within 3 seconds for manual soldering.

■ Ordering Information

Description	Model
Photomicrosensor (transmissive)	EE-SX1131

■ Electrical and Optical Characteristics (Ta = 25°C)

Item	Symbol	Value	Condition
Emitter	Forward voltage	V_F 1.1 V typ., 1.3 V max.	$I_F = 5$ mA
	Reverse current	I_R 10 μA max.	$V_R = 5$ V
	Peak emission wavelength	λ_P 940 nm typ.	$I_F = 20$ mA
Detector	Light current	I_{L1}/I_{L2} 50 μA min., 150 μA typ., 500 μA max.	$I_F = 5$ mA, $V_{CE} = 5$ V
	Dark current	I_D 100 nA max.	$V_{CE} = 10$ V, 0 lx
	Leakage current	I_{LEAK} ---	---
	Collector–Emitter saturated voltage	$V_{CE(sat)}$ 0.1 V typ., 0.4 V max.	$I_F = 20$ mA, $I_L = 50$ μA
	Peak spectral sensitivity wavelength	λ_P 900 nm typ.	---
Rising time	t_r 10 μs typ.	$V_{CC} = 5$ V, $R_L = 1$ k Ω , $I_L = 100$ μA	
Falling time	t_f 10 μs typ.	$V_{CC} = 5$ V, $R_L = 1$ k Ω , $I_L = 100$ μA	

■ Engineering Data

Forward Current vs. Collector Dissipation Temperature Rating

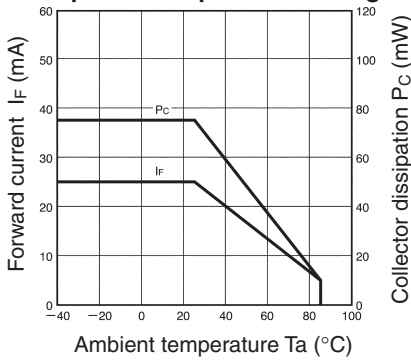

Forward Current vs. Forward Voltage Characteristics (Typical)

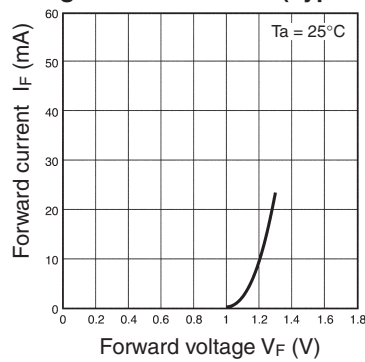

Light Current vs. Forward Current Characteristics (Typical)

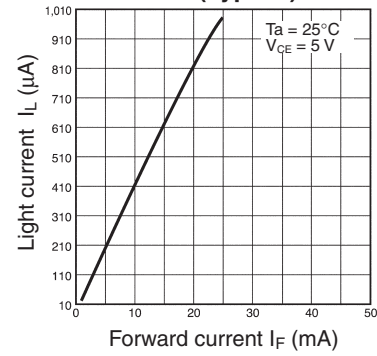

Light Current vs. Collector-Emitter Voltage Characteristics (Typical)

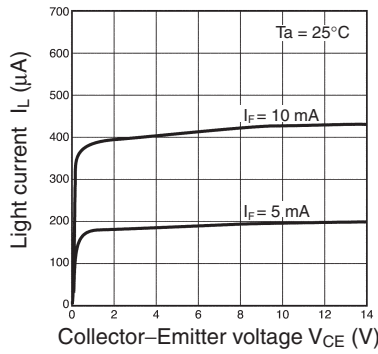

Relative Light Current vs. Ambient Temperature Characteristics (Typical)

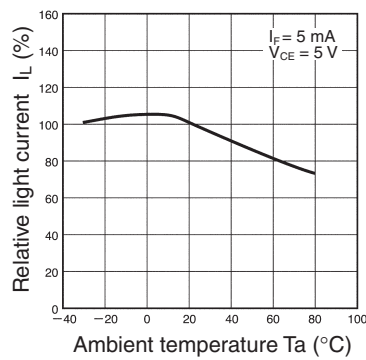

Dark Current vs. Ambient Temperature Characteristics

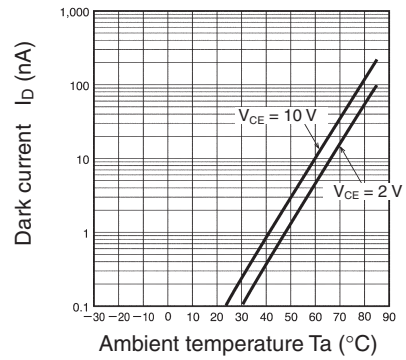

Response Time vs. Load Resistance Characteristics (Typical)

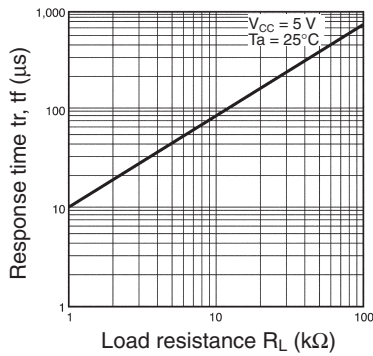

Sensing Position Characteristics (Typical)

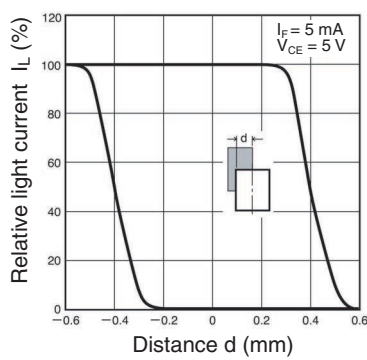

Sensing Position Characteristics (Typical)

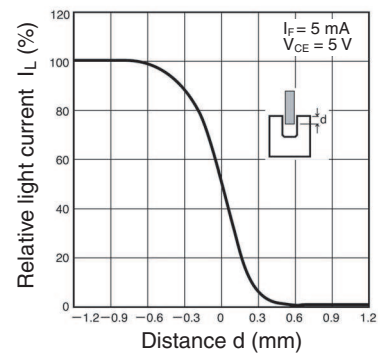

Response Time Measurement Circuit

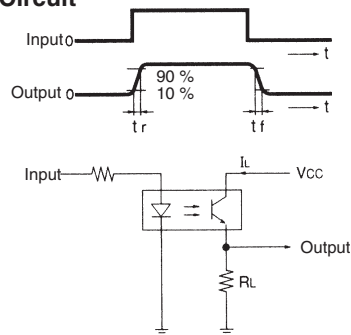

Unit: mm (inch)

■ Tape and Reel

Reel

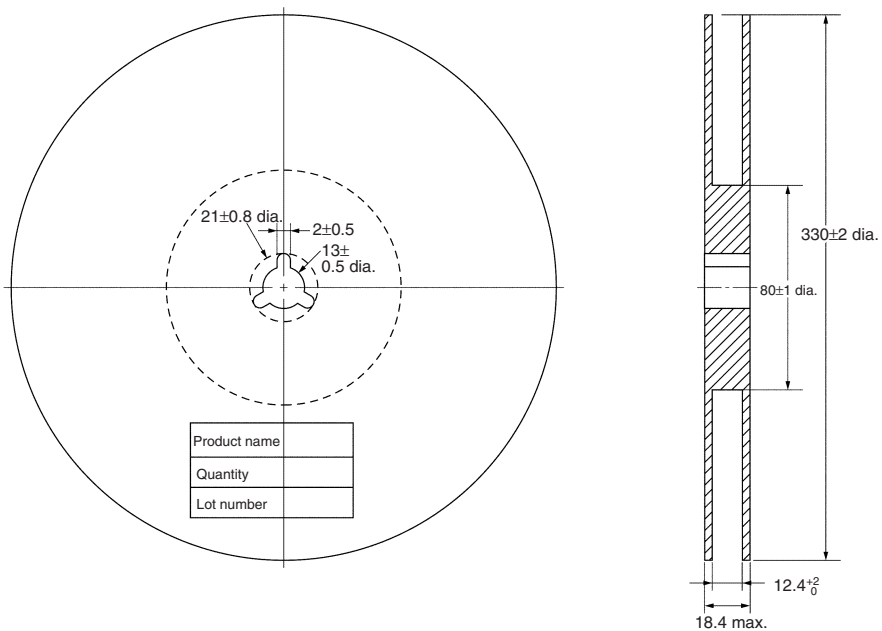

Tape

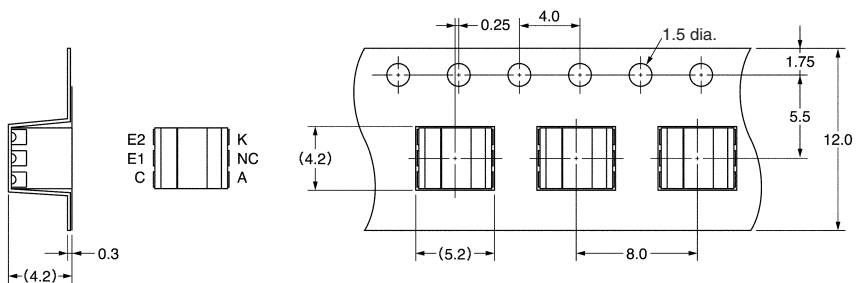

Tape configuration

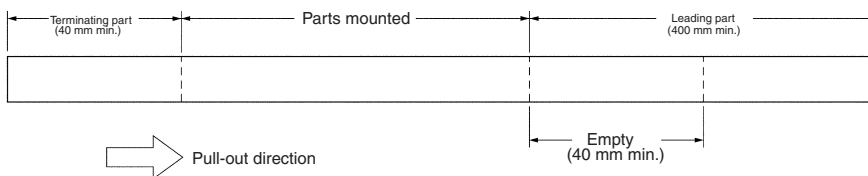

Tape quantity

2,000 pcs./reel

Precautions

■ Soldering Information

Reflow soldering

- The following soldering paste is recommended:
Melting temperature: 216 to 220°C
Composition: Sn 3.5 Ag 0.75 Cu
- The recommended thickness of the metal mask for screen printing is between 0.2 and 0.25 mm.
- Set the reflow oven so that the temperature profile shown in the following chart is obtained for the upper surface of the product being soldered.

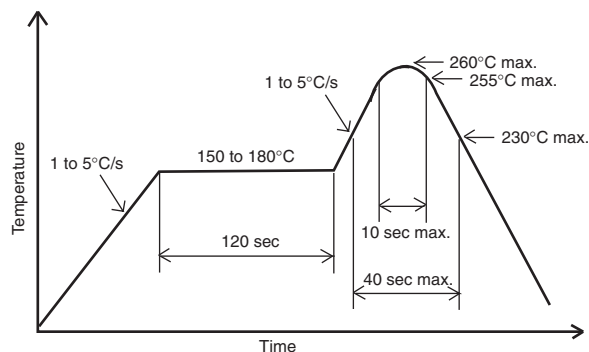

Manual soldering

- Use "Sn 60" (60% tin and 40% lead) or solder with silver content.
- Use a soldering iron of less than 25 W, and keep the temperature of the iron tip at 300°C or below.
- Solder each point for a maximum of three seconds.
- After soldering, allow the product to return to room temperature before handling it.

Storage

To protect the product from the effects of humidity until the package is opened, dry-box storage is recommended. If this is not possible, store the product under the following conditions:

Temperature: 10 to 30°C

Humidity: 60% max.

The product is packed in a humidity-proof envelope. Reflow soldering must be done within 48 hours after opening the envelope, during which time the product must be stored under 30°C at 80% maximum humidity.

If it is necessary to store the product after opening the envelope, use dry-box storage or reseal the envelope.

Baking

If a product has remained packed in a humidity-proof envelope for six months or more, or if more than 48 hours have lapsed since the envelope was opened, bake the product under the following conditions before use:

Reel: 60°C for 24 hours or more

Bulk: 80°C for 4 hours or more

A large grid of 20 columns and 30 rows of small squares, intended for handwritten notes. The grid is composed of thin, light gray lines forming a uniform pattern across the page.

All sales are subject to Omron Electronic Components LLC standard terms and conditions of sale, which can be found at http://www.components.omron.com/components/web/webfiles.nsf/sales_terms.html

ALL DIMENSIONS SHOWN ARE IN MILLIMETERS.
To convert millimeters into inches, multiply by 0.03937. To convert grams into ounces, multiply by 0.03527.

OMRON[®]

**OMRON ELECTRONIC
COMPONENTS LLC**

55 E. Commerce Drive, Suite B
Schaumburg, IL 60173

847-882-2288

OMRON ON-LINE

Global - <http://www.omron.com>

USA - <http://www.components.omron.com>