

**SERIES 84S**  
Sealed

**FEATURES**

- Waterproof Silicone Rubber
- Easily Customized Legends
- Audible, Tactile Contacts
- Low Contact Resistance
- Optional RFI/EMI Shielding
- 3,000,000 Operations per Button



Keyboards and Keypads

**DIMENSIONS** In inches (and millimeters)

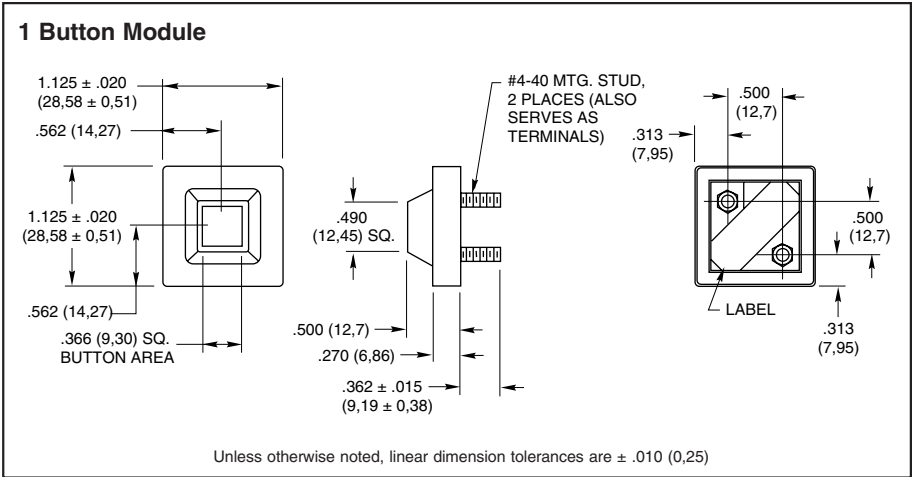

**CIRCUITRY**

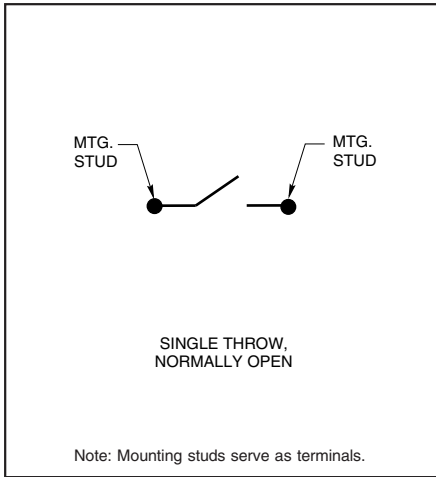

**3x4 Keyboard**

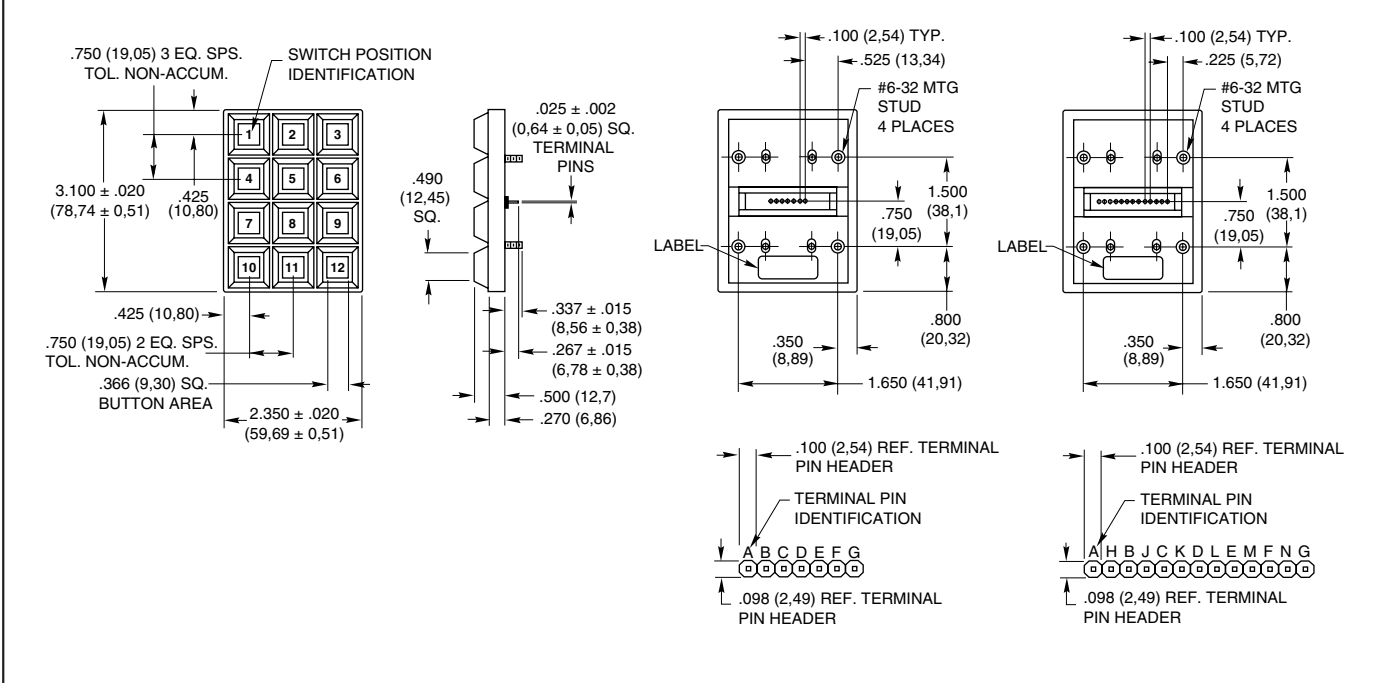

**DIMENSIONS** In inches (and millimeters)

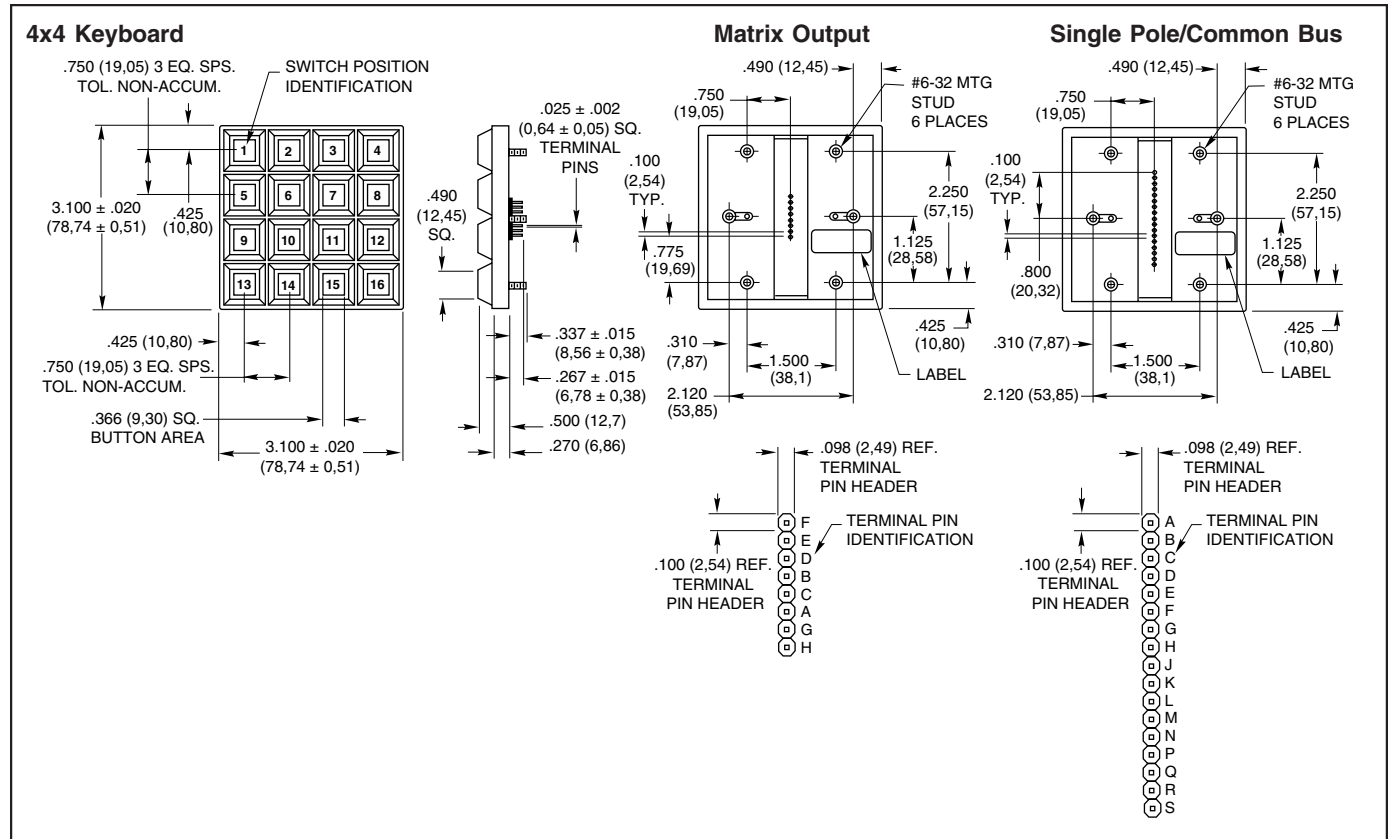

**CODE AND TRUTH TABLES**

Dots in the chart indicate connected terminals when switch is closed. Terminals are identified on the keyboard.

**12 Button Keypads**

3x4	CODES	
	Matrix	Single Pole/Common Bus
1	•	•
2	•	•
3	•	•
4	•	•
5	•	•
6	•	•
7	•	•
8	•	•
9	•	•
10	•	•
11	•	•
12	•	•
	C B A G F E D	E C B F D A N K H M L J G
	TERMINAL LOCATION	

**16 Button Keypads**

4x4	CODES	
	Matrix	Single Pole/Common Bus
1	•	•
2	•	•
3	•	•
4	•	•
5	•	•
6	•	•
7	•	•
8	•	•
9	•	•
10	•	•
11	•	•
12	•	•
13	•	•
14	•	•
15	•	•
16	•	•
	A B C D E F G H	D B A C H F E G K M L J P R Q N S
	TERMINAL LOCATION	

**SPECIFICATIONS**

**Rating Criteria**

- Rating at 24 Vdc:** ≤10 milliamps resistive
- Contact Bounce:** 4 milliseconds maximum at make; 10 milliseconds at break
- Contact Resistance:** MOS, TTL, and DTL compatible. (10 ohms maximum)
- Life Expectancy:** 3 million operations/button
- Insulation Resistance:** □1,000 megohms

**Operating Features**

- Pre-Travel:** .030 inches minimum
- Operating Temperature:** -55°C to 85°C

- Operating Force:** 20 ± 4 ounces
- Humidity:** 0 to 98% (no condensation)
- Minimum Push Out Force Per Pin:** 5 pounds

**Materials and Finishes**

- Terminal Pins:** Copper alloy CDA 725, solder-plated
- PC Board:** FR-4 glass cloth epoxy
- Contact Dome:** Stainless steel, selectively gold-plated
- Dome Retainer/Rear Seal Sheet:** Polyester

- Mounting Studs:** Phosphor bronze
- Optional Hex Nut:** Stainless steel, passivated
- Optional EMI Shield:** Aluminum foil
- Keypad:** Silicone rubber
- Buttons:** ABS Cyclac, grade FR15U

**Shielding Effectiveness**

Results shown are typical for a standard Grayhill Series 84S Keyboard. A conductive gasket will generally increase the shielding, depending on the size and shape of the gasket and its material. Data derived for E-Field Radiation.

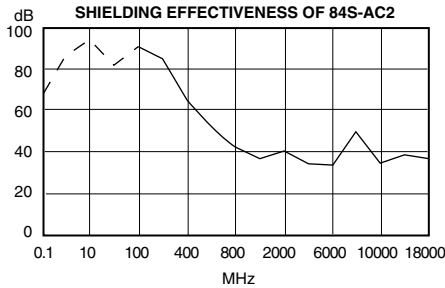

Frequency MHz	Rating in dB
0.1	66.2
10	94.8
100	90.5
400	64.2
800	42.3
2,000	40.5
6,000	33.1
10,000	34.4
18,000	37.0

receiving equipment. A signal generator provided the frequency source that was radiated from the transmitting antenna to the enclosed receiving antenna. The spacing between antennas was maintained constant throughout the frequency range. The effectiveness rating is determined by establishing a reference reading without obstruction between the two antennas and determining the difference between that reading and the test setup reading.

**Note:**

When measured in actual equipment, shielding effectiveness is determined by many factors. This method accurately represents the shielding effectiveness of the Grayhill Series 84S under ideal test conditions.

**Test Method:**

Measurements were made with the keyboard mounted to a brass plate, which in turn was mounted to a shielded enclosure containing the

**STANDARD LEGENDS**

**Available through Grayhill Distributors**

To order one of the configurations below, use the dash number shown here; select the keypad size and code, and order the part number with the appropriate legend dash number. The buttons in these keypads can be removed, and reinserted in any configuration.

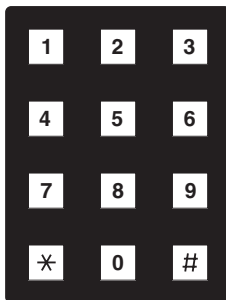

-112

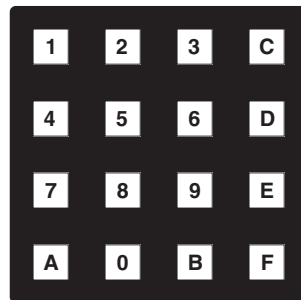

-014

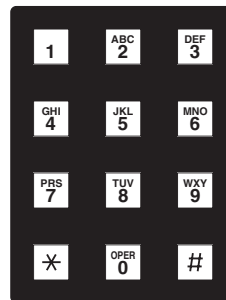

-113

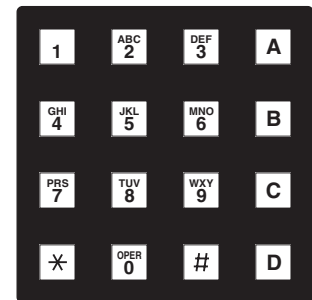

-016

**CUSTOM LEGENDS**

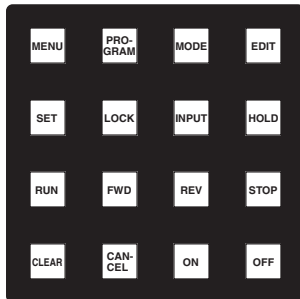

**Library of Legends**

Grayhill maintains a legend library which contains the most often requested special legends and many unusual ones. If the legend is in the library, the cost to utilize this legend in your keypad configuration is minimal. If the legend is not available, Grayhill can list the charges required to add your legend to the library. In this manner, new legends are added on a periodic basis. Custom legends to fit your unique requirements may not be as expensive as you think, contact Grayhill.

**Adding Color**

Use colored buttons to segregate button groupings or to provide originality. Available in black legends on white or yellow buttons, or in white legends on black, green, red or blue buttons. Two popular combinations, black on white and white on black, are available from Grayhill stock. Delivery time will increase for other color combinations.



**HEADER CONNECTORS**

Compatible with: Samtec, Inc. Header Series BCS, BSW, CES, ESW, ESQ, SLW, SSW, SSQ, IDSS and IDSD or equivalent.

Available from your local Grayhill Distributor. For prices and discounts, contact a local Sales Office, an authorized local Distributor or Grayhill.

**ORDERING INFORMATION**

**84S-AC2-113-N**

- Grayhill Series Number**
- Shielded or Non-Shielded Option**  
S = Shielded; SN = Non-Shielded
- Size Option:** A = 3x4; B = 4x4; C = 1 Button
- Circuitry Option (B2 and C2 not applicable to 1 button)**  
B2 = Matrix in-line pins  
C2 = Single pole/common bus, in-line pins  
C3 = 1 Button, SPST-N.O., non-shielded only
- Mounting Nut Option**  
N = Provided with hex nuts for mounting; Blank = Nuts not provided
- Standard Legend Choices**  
3x4 Size: -112 or -113; -000, No buttons; -101, Blank Buttons  
4x4 Size: -014 or -016; -000, No buttons; -001, Blank Buttons  
1 Button Size: -001, No legend, white button