

Ultra Linear Low Noise

Monolithic Amplifier

PGA-103+

50Ω 0.05 to 4 GHz

The Big Deal

- Ultra High IP3
- Broadband High Dynamic Range without external Matching Components
- May be used as a replacement for RFMD SPF-5189Z^{a,b}



SOT-89 PACKAGE

Product Overview

PGA-103+ (RoHS compliant) is an advanced wideband amplifier fabricated using E-PHEMT technology and offers extremely high dynamic range over a broad frequency range and with low noise figure. In addition, the PGA-103+ has good input and output return loss over a broad frequency range without the need for external matching components and has demonstrated excellent reliability. Lead finish is SnAgNi. It has repeatable performance from lot to lot and is enclosed in a SOT-89 package for very good thermal performance.

Key Features

Feature	Advantages
Broad Band: 0.05 to 4.0 GHz	Broadband covering primary wireless communications bands: Cellular, PCS, LTE, WiMAX
Ultra High IP3 Versus DC power Consumption: 45 dBm typical at 2 GHz at +5.0V Supply Voltage and only 97mA	The PGA-103+ provides excellent IP3 performance relative to device size and power consumption. The combination of the design and E-PHEMT Structure provides enhanced linearity over a broad frequency range as evidence in the IP3 being typically 20 dB above the P 1dB point. This feature makes this amplifier ideal for use in: <ul style="list-style-type: none">• Driver amplifiers for complex waveform up converter paths• Drivers in linearized transmit systems• Secondary amplifiers in ultra High Dynamic range receivers
No External Matching Components Required	Unlike competing products, Mini-Circuits PGA-103+ provides Input and Output Return Loss of 11-24 dB over 0.4-4 GHz without the need for any external matching components
Low Noise Figure: 0.6 dB up to 1.0 GHz	A unique feature of the PGA-103+ which separates this design from all competitors is the low noise figure performance in combination with the high dynamic range.

Notes:

- a. Suitability for model replacement within a particular system must be determined by and is solely the responsibility of the customer based on, among other things, electrical performance criteria, stimulus conditions, application, compatibility with other components and environmental conditions and stresses.
- b. The RFMD SPF-5189Z part number is used for identification and comparison purposes only.

Notes

- A. Performance and quality attributes and conditions not expressly stated in this specification document are intended to be excluded and do not form a part of this specification document.
- B. Electrical specifications and performance data contained in this specification document are based on Mini-Circuit's applicable established test performance criteria and measurement instructions.
- C. The parts covered by this specification document are subject to Mini-Circuits standard limited warranty and terms and conditions (collectively, "Standard Terms"); Purchasers of this part are entitled to the rights and benefits contained therein. For a full statement of the Standard Terms and the exclusive rights and remedies thereunder, please visit Mini-Circuits' website at www.minicircuits.com/MCLStore/terms.jsp



Ultra Linear Low Noise Monolithic Amplifier

0.05-4 GHz

Product Features

- 5V/3V operation
- High IP3, 45 dBm typ. at 2 GHz, Vd=5V
- Low Noise Figure, 0.6 at 1 GHz; 0.9 dB at 2 GHz
- Gain, 11.0 dB typ. at 2 GHz
- P1dB 22.5 dBm typ. at 2 GHz at Vd=5V
- No external matching components required
- May be used as a replacement for RFMD SPF-5189Z^{a,b}

Typical Applications

- Base station infrastructure
- Portable Wireless
- CATV & DBS
- MMDS & Wireless LAN
- LTE



PGA-103+

CASE STYLE: DF782
PRICE: \$1.99 ea. QTY. (20)

+RoHS Compliant

The +Suffix identifies RoHS Compliance. See our web site for RoHS Compliance methodologies and qualifications

General Description

PGA-103+ (RoHS compliant) is an advanced wideband amplifier fabricated using E-PHEMT technology and offers extremely high dynamic range over a broad frequency range and with low noise figure. In addition, the PGA-103+ has good input and output return loss over a broad frequency range without the need for external matching components. Lead finish is SnAgNi. It has repeatable performance from lot to lot and is enclosed in a SOT-89 package for very good thermal performance.

simplified schematic and pin description

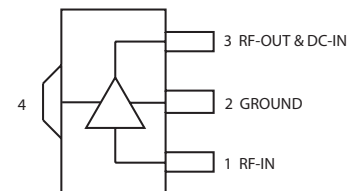
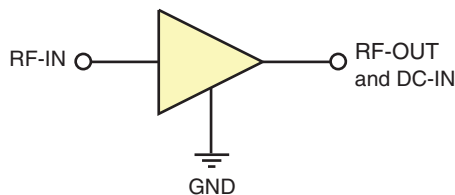

Function	Pin Number	Description
RF IN	1	RF input pin. This pin requires the use of an external DC blocking capacitor chosen for the frequency of operation.
RF-OUT and DC-IN	3	RF output and bias pin. DC voltage is present on this pin; therefore a DC blocking capacitor is necessary for proper operation. An RF choke is needed to feed DC bias without loss of RF signal due to the bias connection, as shown in "Recommended Application Circuit", Fig. 2
GND	2,4	Connections to ground. Use via holes as shown in "Suggested Layout for PCB Design" to reduce ground path inductance for best performance.

Notes:

- a. Suitability for model replacement within a particular system must be determined by and is solely the responsibility of the customer based on, among other things, electrical performance criteria, stimulus conditions, application, compatibility with other components and environmental conditions and stresses.
- b. The RFMD SPF-5189Z part number is used for identification and comparison purposes only.

Notes

- A. Performance and quality attributes and conditions not expressly stated in this specification document are intended to be excluded and do not form a part of this specification document.
- B. Electrical specifications and performance data contained in this specification document are based on Mini-Circuit's applicable established test performance criteria and measurement instructions.
- C. The parts covered by this specification document are subject to Mini-Circuits standard limited warranty and terms and conditions (collectively, "Standard Terms"); Purchasers of this part are entitled to the rights and benefits contained therein. For a full statement of the Standard Terms and the exclusive rights and remedies thereunder, please visit Mini-Circuits' website at www.minicircuits.com/MCLStore/terms.jsp



Electrical Specifications⁽¹⁾ at 25°C, 50Ω, unless noted

Parameter	Condition (GHz)	Vd=5V			Vd=3V	Units
		Min.	Typ.	Max.	Typ.	
Frequency Range		0.05		4.0		GHz
Gain	0.05		26.5		25.9	dB
	0.4		22.1		21.6	
	1.0	14.7	16.2	18.0	15.8	
	2.0		11.0		10.6	
	3.0		8.1		7.7	
	4.0		6.2		5.9	
Noise Figure	0.05		0.5		0.5	dB
	0.4		0.5		0.5	
	1.0		0.6		0.6	
	2.0		0.9		0.9	
	3.0		1.2		1.2	
	4.0		1.5		1.4	
Input Return Loss	0.05		6.7		6.1	dB
	0.4		11.3		10.4	
	1.0	10.0	13.0		12.0	
	2.0		12.8		13.0	
	3.0		13.7		13.0	
	4.0		15.0		14.2	
Output Return Loss	0.05		14.1		13.8	dB
	0.4		23.8		25.5	
	1.0	10.0	21.8		30.6	
	2.0		20.6		26.4	
	3.0		17.2		20.8	
	4.0		16.0		19.2	
Reverse Isolation	1.0		21.2		20.5	dB
Output Power @ 1 dB compression ⁽²⁾	0.05		20.0		15.4	dBm
	0.4		21.5		18.2	
	1.0		22.5		18.7	
	2.0		22.5		19.3	
	3.0		22.9		20.0	
	4.0		23.2		20.7	
Output IP3	0.05		36.7		32.4	dBm
	0.4		39.0		34.1	
	1.0		41.9		34.5	
	2.0	40.0	44.6		35.6	
	3.0		44.3		35.6	
	4.0		45.4		35.3	
Device Operating Voltage		4.8	5.0	5.2	3.0	V
Device Operating Current			97	120	60	mA
Device Current Variation vs. Temperature			-178		-54	μA/°C
Device Current Variation vs Voltage			0.014		0.018	mA/mV
Thermal Resitance			36		36	°C/W

⁽¹⁾ Measured on Mini-Circuits Characterization test board TB-313. See Characterization Test Circuit (Fig. 1)

⁽²⁾ Current increases at P1dB

Absolute Maximum Ratings

Parameter	Ratings
Operating Temperature (ground lead)	-40°C to 85°C
Storage Temperature	-65°C to 150°C
Operating Current at 5.0V	200 mA
Power Dissipation at 5.0V	1W
Input Power (CW)	+21 dBm (50 to 2000 MHz) +26 dBm (2000 to 4000 MHz)
DC Voltage on Pin 3	6V

Notes:

Permanent damage may occur if any of these limits are exceeded.
Electrical maximum ratings are not intended for continuous normal operation.

Notes

- A. Performance and quality attributes and conditions not expressly stated in this specification document are intended to be excluded and do not form a part of this specification document.
- B. Electrical specifications and performance data contained in this specification document are based on Mini-Circuit's applicable established test performance criteria and measurement instructions.
- C. The parts covered by this specification document are subject to Mini-Circuits standard limited warranty and terms and conditions (collectively, "Standard Terms"); Purchasers of this part are entitled to the rights and benefits contained therein. For a full statement of the Standard Terms and the exclusive rights and remedies thereunder, please visit Mini-Circuits' website at www.minicircuits.com/MCLStore/terms.jsp

DC Current Histogram, Vd=5V

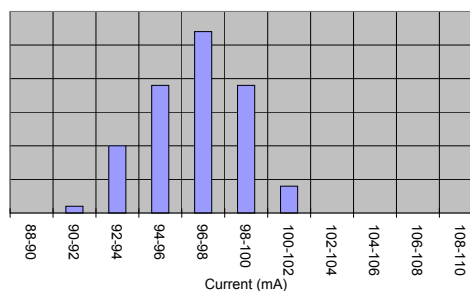

Characterization Test Circuit

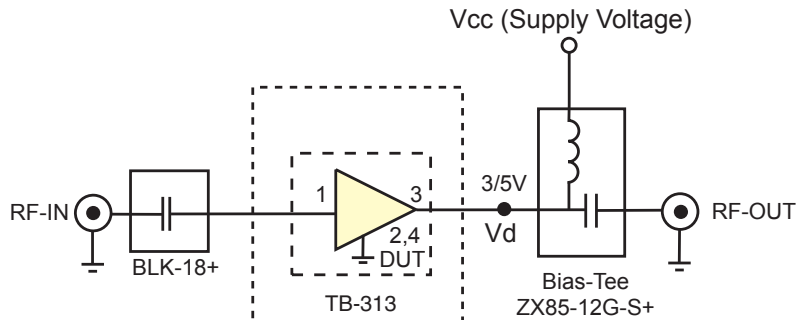
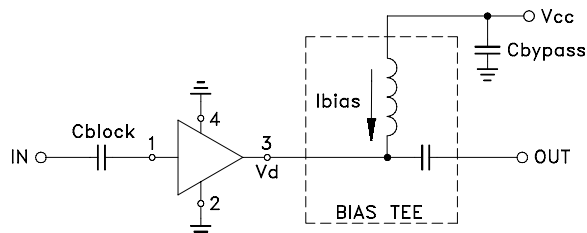

Fig 1. Block Diagram of Test Circuit used for characterization. (DUT tested on Mini-Circuits Characterization test board TB-313) Gain, Return loss, Output power at 1dB compression (P1 dB) , output IP3 (OIP3) and noise figure measured using Agilent’s N5242A PNA-X microwave network analyzer.

Conditions:

1. Gain and Return loss: Pin= -25dBm
2. Output IP3 (OIP3): Two tones, spaced 1 MHz apart, 5 dBm/tone at output.

Recommended Application Circuit



Cblock=0.001µF, Bias-Tee=TCBT-14+, Cbypass=0.1µF

Fig 2a. Evaluation board includes case, connectors and components soldered to PCB

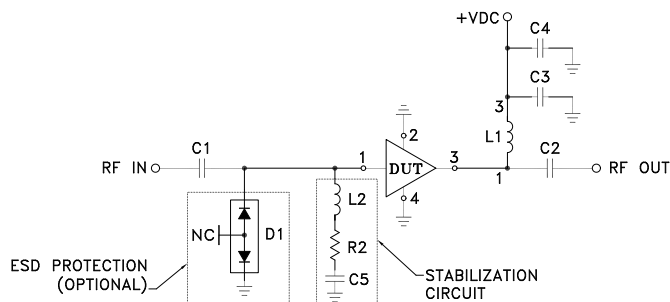
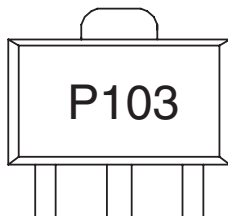

Fig 2b. Evaluation board unconditionally stable (see note AN-60-064)

Product Marking



SEQ	Manufacturer P/N	Size
A1	PGA-103+	—
C1, C2	.01 uF	0805
C3	.01 uF	1206
C4	.01 uF	1206
C5	.01 pF	0603
D1	ESD Diode (see note 3)	SOT 723
L1	TCCH-80+	—
L2	620 nH	.115X.110
R2	150 Ohm	0603

Notes

- Performance and quality attributes and conditions not expressly stated in this specification document are intended to be excluded and do not form a part of this specification document.
- Electrical specifications and performance data contained in this specification document are based on Mini-Circuit’s applicable established test performance criteria and measurement instructions.
- The parts covered by this specification document are subject to Mini-Circuits standard limited warranty and terms and conditions (collectively, “Standard Terms”); Purchasers of this part are entitled to the rights and benefits contained therein. For a full statement of the Standard Terms and the exclusive rights and remedies thereunder, please visit Mini-Circuits’ website at www.minicircuits.com/MCLStore/terms.jsp



Additional Detailed Technical Information	
<i>additional information is available on our dash board. To access this information click here</i>	
Performance Data	Data Table
	Swept Graphs
	S-Parameter (S2P Files) Data Set (.zip file)
Case Style	DF782 (SOT 89) <i>Plastic package, exposed paddle lead finish: tin-silver over nickel</i>
Tape & Reel Standard quantities available on reel	F55 <i>7" reels with 20, 50, 100, 200, 500 or 1K devices</i>
Suggested Layout for PCB Design	PL-313
Evaluation Board	TB-678-103+ TB-761-103+ (see Application Note AN-60-064)
Environmental Ratings	ENV08T1

ESD Rating

Human Body Model (HBM): Class 1A (250 to <500V) in accordance with ANSI/ESD STM 5.1 - 2001

Machine Model (MM): Class M1(25V) in accordance with ANSI/ESD STM5.2-1999



Attention
Observe precautions for handling electrostatic sensitive devices

MSL Rating

Moisture Sensitivity: MSL1 in accordance with IPC/JEDEC J-STD-020D

MSL Test Flow Chart

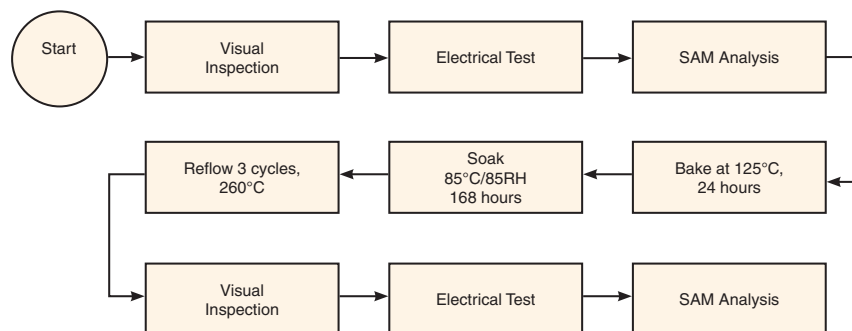

Notes

- A. Performance and quality attributes and conditions not expressly stated in this specification document are intended to be excluded and do not form a part of this specification document.
- B. Electrical specifications and performance data contained in this specification document are based on Mini-Circuit's applicable established test performance criteria and measurement instructions.
- C. The parts covered by this specification document are subject to Mini-Circuits standard limited warranty and terms and conditions (collectively, "Standard Terms"); Purchasers of this part are entitled to the rights and benefits contained therein. For a full statement of the Standard Terms and the exclusive rights and remedies thereunder, please visit Mini-Circuits' website at www.minicircuits.com/MCLStore/terms.jsp

