

High Gain, High IP3

Wideband Amplifier

ZX60-V63+

50Ω 0.05 to 6 GHz



Case Style: GC957

The Big Deal

- High Gain
- Broadband High Dynamic Range
- Wideband, 0.05 to 6 GHz

Product Overview

The ZX60-V63+ (RoHS compliant) uses Mini-Circuits' HBT technology to offer high gain over a broad frequency range and high IP3. Housed in a rugged, cost effective unibody chassis, this amplifier supports a wide variety of applications requiring moderate power output, low distortion and 50 ohm matched input/output ports.

Key Features

Feature	Advantages
High Gain 21.9 dB typ. at 0.05 GHz 15.4 dB typ. at 6 GHz	High gain reduces number of gain stages, at lower real estate, component count and cost. ±1.7 dB gain flatness from 50 MHz to 3 GHz
Broadband: 0.05 to 6 GHz	Broadband covering primary wireless communications bands: Cellular, PCS, LTE, WiMAX, UHF, VHF, L band, Satcom, radar, etc.
High IP3 vs. DC power consumption 34.2 dBm typical at 0.05 GHz 33.3 dBm typical at 0.8 GHz	This model matches good IP3 performance relative to power consumption. The HBT structure provides good linearity over a broad frequency range as shown in the IP3 being typically 16 dB above the P1dB point to 0.8 GHz. This feature makes this amplifier ideal for use in: <ul style="list-style-type: none">• driver amplifiers for complex waveform upconverter paths• drivers in linearized transmit systems
Very Small Size, 0.75" x 0.75"	The unique unibody construction enables the ZX60-V63+ to be used in compact designs.

Notes

- A. Performance and quality attributes and conditions not expressly stated in this specification document are intended to be excluded and do not form a part of this specification document.
B. Electrical specifications and performance data contained in this specification document are based on Mini-Circuit's applicable established test performance criteria and measurement instructions.
C. The parts covered by this specification document are subject to Mini-Circuits standard limited warranty and terms and conditions (collectively, "Standard Terms"); Purchasers of this part are entitled to the rights and benefits contained therein. For a full statement of the Standard Terms and the exclusive rights and remedies thereunder, please visit Mini-Circuits' website at www.minicircuits.com/MCLStore/terms.jsp



High Gain, High IP3 Wideband Amplifier

ZX60-V63+

50Ω 0.05 to 6 GHz

Features

- Gain, 21 dB typ. at 0.8 GHz
- Flat Gain, ±1.7 dB from 50 to 3000 MHz
- High Pout, P1dB, +18.5 dBm typ. at 0.8 GHz
- High IP3, 33.3 dBm typ. at 0.8 GHz

Applications

- Base station infrastructure
- Portable wireless
- CATV & DBS
- MMDS & Wireless LAN
- LTE
- SATCOM
- Radar



Case Style: GC957

Connectors	Model	Price	Qty.
SMA	ZX60-V63+	\$49.95 ea.	(1-9)

+RoHS Compliant

The +Suffix identifies RoHS Compliance. See our web site for RoHS Compliance methodologies and qualifications

Electrical Specifications at 25°C and 5.0V unless noted

Parameter	Condition (GHz)	Min.	Typ.	Max.	Units
Frequency Range		0.05		6	GHz
Gain	0.05	19.0	21.9		dB
	0.8		21.1		
	2.0		20.3		
	3.0		19.2		
	4.0		18.0		
Gain Flatness	6.0	15.4		dB	
	0.05 - 3.0	±1.7			
	0.7 - 2.6	±1.3			
	0.05	14.8			
	0.8	23.6			
Input Return Loss	2.0	14.0	16.7		dB
	3.0		10.8		
	4.0		10.8		
	6.0		13.4		
	0.05		15.7		
Output Return Loss	0.8	12.0	15.5		dB
	2.0		13.6		
	3.0		15.9		
	4.0		24.1		
	6.0		11.8		
Output IP3	0.05		34.2		dBm
	0.8		33.3		
	2.0		31.2		
	3.0		28.8		
	4.0		27.7		
Output Power @ 1 dB compression	6.0	17.0	23.9		dBm
	0.05		18.4		
	0.8		18.5		
	2.0		17.8		
	3.0		16.1		
Noise Figure	4.0		15.0		dB
	6.0		12.1		
	0.05		3.6		
	0.8		3.7		
	2.0		3.7		
Directivity (Isolation-Gain)	3.0		3.8		dB
	4.0		3.8		
	6.0		4.3		
	0.05 - 6		4.0		
	DC Voltage				
DC Current		58	69	78	mA

Notes

- Performance and quality attributes and conditions not expressly stated in this specification document are intended to be excluded and do not form a part of this specification document.
- Electrical specifications and performance data contained in this specification document are based on Mini-Circuit's applicable established test performance criteria and measurement instructions.
- The parts covered by this specification document are subject to Mini-Circuits standard limited warranty and terms and conditions (collectively, "Standard Terms"); Purchasers of this part are entitled to the rights and benefits contained therein. For a full statement of the Standard Terms and the exclusive rights and remedies thereunder, please visit Mini-Circuits' website at www.minicircuits.com/MCLStore/terms.jsp



Maximum Ratings

Parameter	Ratings
Operating Temperature	-40°C to 85°C Case
Storage Temperature	-55°C to 100°C
DC Voltage	5.7 V
Input RF Power (no damage)	13 dBm
Power Consumption	0.5 W

Permanent damage may occur if any of these limits are exceeded.

Outline Drawing

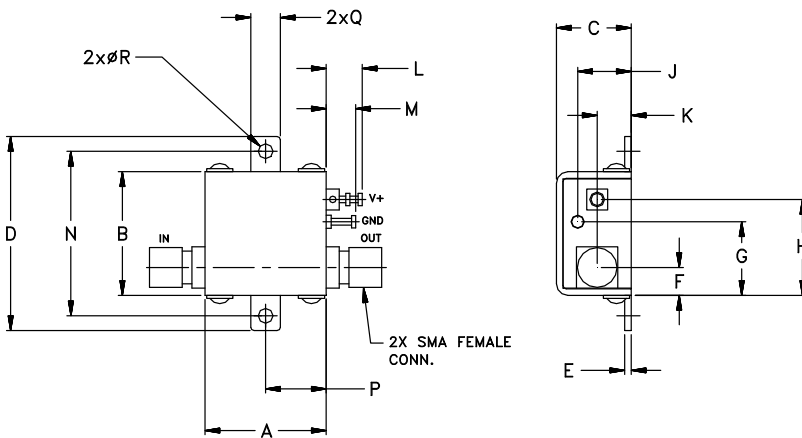

Outline Dimensions (inch)

A	B	C	D	E	F	G	H	J	K	L	M	N	P	Q	R	wt
.74	.75	.46	1.18	.04	.17	.45	.59	.33	.21	.22	.18	1.00	.37	.18	.106	grams
18.80	19.05	11.68	29.97	1.02	4.32	11.43	14.99	8.38	5.33	5.59	4.57	25.40	9.40	4.57	2.69	23.0

Notes

- Performance and quality attributes and conditions not expressly stated in this specification document are intended to be excluded and do not form a part of this specification document.
- Electrical specifications and performance data contained in this specification document are based on Mini-Circuit's applicable established test performance criteria and measurement instructions.
- The parts covered by this specification document are subject to Mini-Circuits standard limited warranty and terms and conditions (collectively, "Standard Terms"); Purchasers of this part are entitled to the rights and benefits contained therein. For a full statement of the Standard Terms and the exclusive rights and remedies thereunder, please visit Mini-Circuits' website at www.minicircuits.com/MCLStore/terms.jsp



FREQUENCY (MHz)	GAIN (dB)	DIRECTIVITY (dB)	VSWR (:1)		POUT at 1dB COMPR. (dBm)	NOISE FIGURE (dB)	OUTPUT IP3 (dBm)
			IN	OUT			
50.00	21.87	2.52	1.44	1.39	18.4	3.6	34.2
500.00	21.28	3.10	1.18	1.31	18.5	3.6	33.7
1000.00	21.04	3.28	1.12	1.46	18.5	3.7	32.3
1400.00	20.80	3.36	1.14	1.54	18.5	3.7	32.2
1600.00	20.66	3.38	1.19	1.55	18.4	3.7	31.8
1800.00	20.49	3.46	1.26	1.55	18.3	3.7	31.8
2000.00	20.29	3.59	1.34	1.53	17.8	3.7	31.2
2400.00	19.88	3.84	1.52	1.47	17.4	3.7	30.5
3000.00	19.21	4.43	1.81	1.38	16.1	3.8	28.8
3400.00	18.74	4.89	1.89	1.31	15.8	3.8	28.8
3800.00	18.22	5.37	1.84	1.19	15.3	3.9	28.0
4000.00	17.96	5.65	1.81	1.13	15.0	3.8	27.7
4600.00	17.09	6.64	1.62	1.21	14.1	3.9	26.4
5000.00	16.59	7.17	1.51	1.35	13.5	4.0	25.7
5500.00	16.23	7.59	1.47	1.61	12.8	4.2	24.8
6000.00	15.41	8.40	1.54	1.69	12.1	4.3	23.9

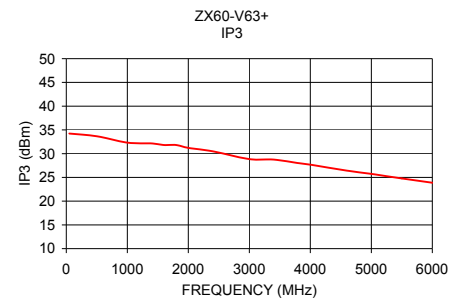
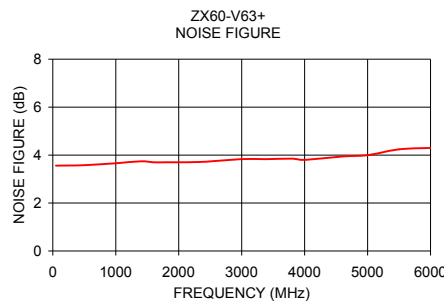
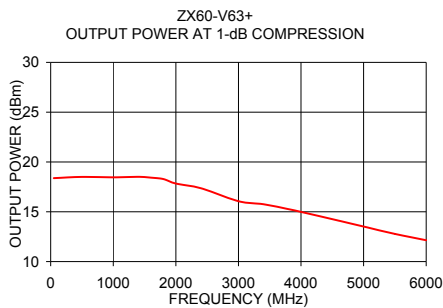
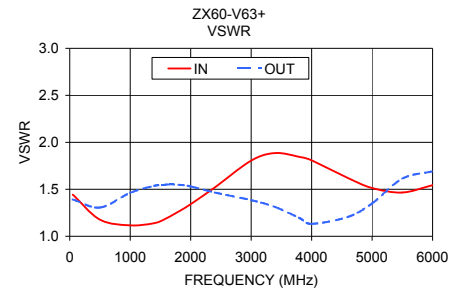
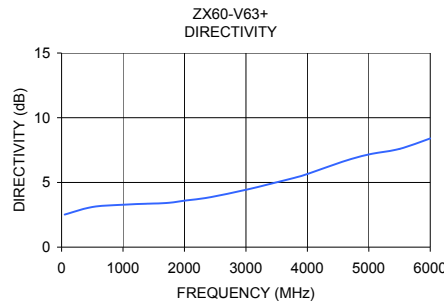
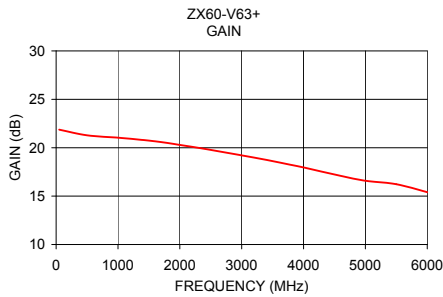

Notes

- A. Performance and quality attributes and conditions not expressly stated in this specification document are intended to be excluded and do not form a part of this specification document.
- B. Electrical specifications and performance data contained in this specification document are based on Mini-Circuits' applicable established test performance criteria and measurement instructions.
- C. The parts covered by this specification document are subject to Mini-Circuits standard limited warranty and terms and conditions (collectively, "Standard Terms"); Purchasers of this part are entitled to the rights and benefits contained therein. For a full statement of the Standard Terms and the exclusive rights and remedies thereunder, please visit Mini-Circuits' website at www.minicircuits.com/MCLStore/terms.jsp

