

# Ceramic Low Pass Filter

50Ω DC<sup>(1)</sup> to 630 MHz

## LFCN-630+ LFCN-630



CASE STYLE: FV1206  
PRICE: \$2.99 ea. QTY (20)

**+RoHS Compliant**  
The +Suffix identifies RoHS Compliance. See our web site for RoHS Compliance methodologies and qualifications

**Available Tape and Reel at no extra cost**  
Reel Size Devices/Reel  
7" 20, 50, 100, 200, 500, 1000, 3000

### Maximum Ratings

Operating Temperature	-55°C to 100°C
Storage Temperature	-55°C to 100°C
RF Power Input*	8.5W max. at 25°C

\* Passband rating, derate linearly to 3.5W at 100°C ambient. Permanent damage may occur if any of these limits are exceeded.

### Pin Connections

RF IN	1
RF OUT	3
GROUND	2,4

### Outline Drawing

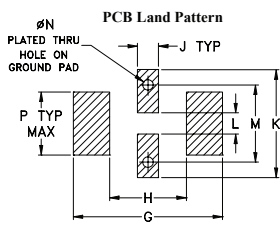
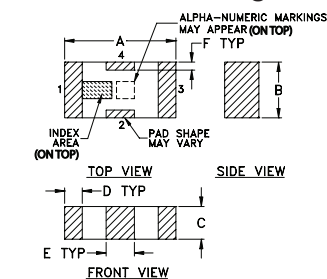

Suggested Layout, Tolerance to be within ±0.02

### Outline Dimensions (inch)

A	B	C	D	E	F	G
.126	.063	.037	.020	.032	.009	.169
3.20	1.60	0.94	0.51	0.81	0.23	4.29

H	J	K	L	M	N	P	wt
.087	.024	.122	.024	.087	.012	.071	grams
2.21	0.61	3.10	0.61	2.21	0.30	1.80	.020

### Demo Board MCL P/N: TB-270 Suggested PCB Layout (PL-137)

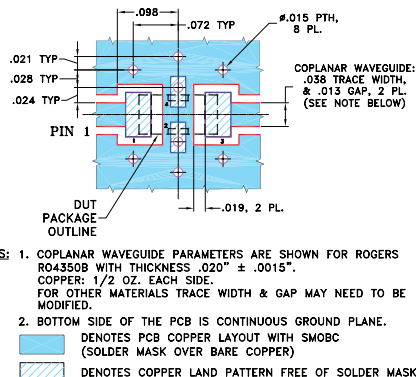

### Features

- excellent power handling, 8.5W
- small size
- 7 sections
- temperature stable
- LTCC construction
- protected by U.S. Patent 6,943,646

### Applications

- harmonic rejection
- VHF/UHF transmitters/receivers
- RF suppression for DC lines on PCB
- anti-aliasing for A/D converter

### Electrical Specifications<sup>(1,2)</sup> at 25°C

Parameter	F#	Frequency (MHz)	Min.	Typ.	Max.	Unit	
Pass Band	Insertion Loss	DC-F1	DC-630	—	—	1.2	dB
	Freq. Cut-Off	F2	830	—	3.0	—	dB
	VSWR	DC-F1	DC-630	—	1.2	—	:1
Stop Band	Rejection Loss	F3	1000	20	—	—	dB
		F4-F5	1050-3500	—	40	—	dB
		F6	6000	—	20	—	dB
VSWR	F3-F6	1000-6000	—	20	—	:1	

(1) In Application where DC voltage is present at either input or output ports, coupling capacitors are required. Alternatively, if DC pass IN-OUT is required, Mini-Circuits' "D" suffix version of this model will support DC IN-OUT, and provide >100 MOhm isolation to ground.

(2) Measured on Mini-Circuits Characterization Test Board TB-270.

### Typical Frequency Response

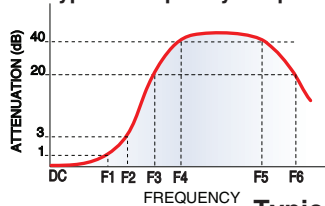

### Electrical Schematic

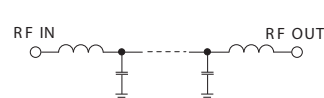

### Typical Performance Data at 25°C

Frequency (MHz)	Insertion Loss (dB)	VSWR (:1)
1.00	0.05	1.01
100.00	0.18	1.06
630.00	0.75	1.13
700.00	0.95	1.20
830.00	2.02	1.39
900.00	7.06	4.64
955.00	16.49	11.38
1000.00	25.84	15.96
1040.00	35.54	18.50
1130.00	66.95	22.29
2015.00	74.70	43.44
3000.00	51.23	49.64
3500.00	45.12	45.72
5000.00	30.26	35.46
6000.00	23.74	25.94

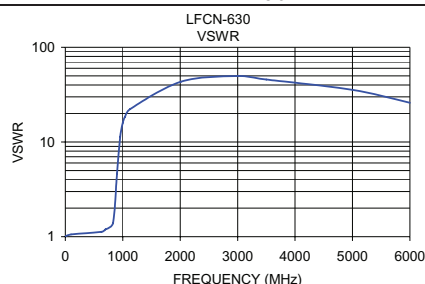
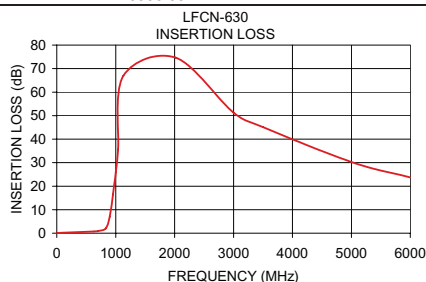

### Notes

- Performance and quality attributes and conditions not expressly stated in this specification document are intended to be excluded and do not form a part of this specification document.
- Electrical specifications and performance data contained in this specification document are based on Mini-Circuit's applicable established test performance criteria and measurement instructions.
- The parts covered by this specification document are subject to Mini-Circuits standard limited warranty and terms and conditions (collectively, "Standard Terms"); Purchasers of this part are entitled to the rights and benefits contained therein. For a full statement of the Standard Terms and the exclusive rights and remedies thereunder, please visit Mini-Circuits' website at [www.minicircuits.com/MCLStore/terms.jsp](http://www.minicircuits.com/MCLStore/terms.jsp)

