

60x60x38 mm

41.5~56.5 CFM



■ Specifications

Model	Bearing	Rating Voltage	Power Current	Power Consumption	Speed	Air Flow	Static Pressure	Noise	Weight	Curve
	2BALL Sleeve	(VDC)	(mA)	(WATTS)	(RPM)	(CFM)	(Inch-H ₂ O)	(dB(A))	(g)	
PMD1206PMB1-A (2).GN	☉	12	880	10.6	8000	56.5	0.92	56.0	90.0	1
PMD1206PMB2-A (2).GN	☉	12	580	7.0	7000	49.2	0.71	52.0	90.0	2
PMD1206PMB3-A (2).GN	☉	12	430	5.2	6000	41.5	0.53	47.0	90.0	3
PMD2406PMB1-A (2).GN	☉	24	430	10.3	8000	56.5	0.92	56.0	90.0	1
PMD2406PMB2-A (2).GN	☉	24	310	7.4	7000	49.2	0.71	52.0	90.0	2
PMD2406PMB3-A (2).GN	☉	24	220	5.3	6000	41.5	0.53	47.0	90.0	3
PMD4806PMB1-A (2).GN	☉	48	240	11.5	8000	56.5	0.92	56.0	90.0	1
PMD4806PMB2-A (2).GN	☉	48	180	8.6	7000	49.2	0.71	52.0	90.0	2
PMD4806PMB3-A (2).GN	☉	48	130	6.2	6000	41.5	0.53	47.0	90.0	3

■ Air Flow-Static Pressure Characteristics

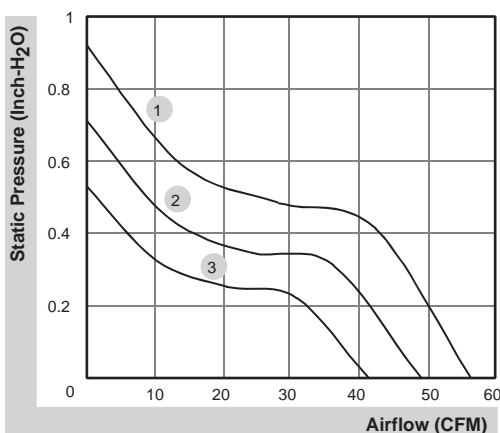

■ External dimensions(mm)

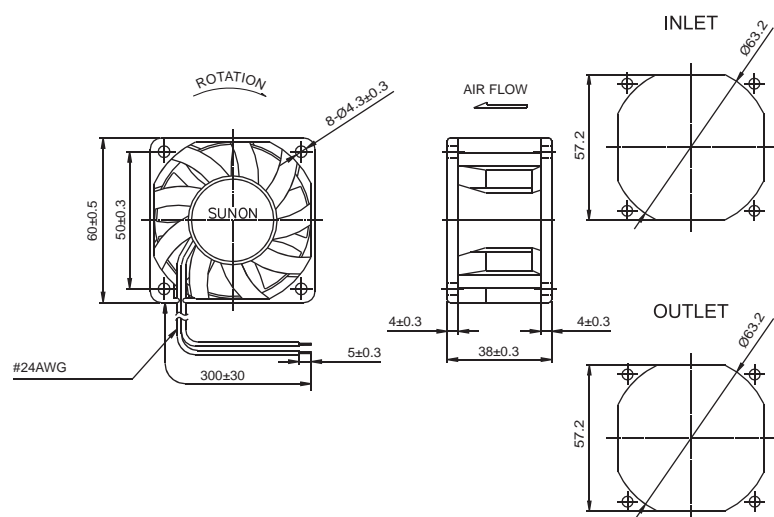

*All model could be customized. Please contact with Sunon Sales.

*Specifications are subject to change without notice. Please Visit SUNON website at <http://www.sunon.com> for update information.