

80x80x20 mm

45.0~53.0 CFM



■ Specifications

	Bearing	Rating Voltage	Power Current	Power Consumption	Speed	Air Flow	Static Pressure	Noise	Weight	Curve
	● VAPO	(VDC)	(mA)	(WATTS)	(RPM)	(CFM)	(Inch-H ₂ O)	(dB(A))	(g)	
PF80201V1-000U-A99	●	12	285	3.42	4600	53.0	0.36	48.0	85.0	1
PF80201V2-000U-A99	●	12	230	2.76	4200	49.0	0.31	45.0	85.0	2
PF80201V3-000U-A99	●	12	195	2.34	3900	45.0	0.26	43.0	85.0	3

■ Air Flow-Static Pressure Characteristics

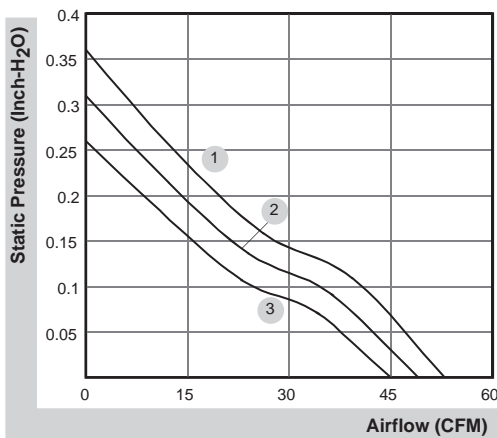

■ External dimensions(mm)

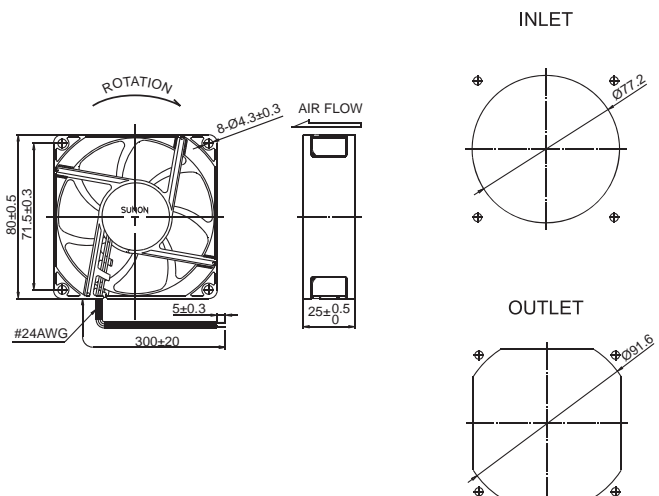

*All model could be customized. Please contact with Sunon Sales.

*Specifications are subject to change without notice. Please Visit SUNON website at <http://www.sunon.com> for update information.