

80x80x20 mm

29.0~36.0 CFM



■ Specifications

	Bearing	Rating Voltage	Power Current	Power Consumption	Speed	Air Flow	Static Pressure	Noise	Weight	Curve
	● VAPO	(VDC)	(mA)	(WATTS)	(RPM)	(CFM)	(Inch-H ₂ O)	(dB(A))	(g)	
ME80201V1-000U-A99	●	12	130	1.56	3300	36.0	0.18	38.0	66.0	1
ME80201V2-000U-A99	●	12	95	1.14	3000	33.0	0.16	35.0	66.0	2
ME80201V3-000U-A99	●	12	74	0.89	2600	29.0	0.12	30.0	66.0	3
ME80202V1-000U-A99	●	24	64	1.54	3300	36.0	0.18	38.0	66.0	1
ME80202V2-000U-A99	●	24	51	1.23	3000	33.0	0.16	35.0	66.0	2
ME80202V3-000U-A99	●	24	42	1.01	2600	29.0	0.12	30.0	66.0	3

Model	Bearing	Rating Voltage	Power Current	Power Consumption	Speed	Air Flow	Static Pressure	Noise	Weight	Curve
	○ 2BALL Sleeve	(VDC)	(mA)	(WATTS)	(RPM)	(CFM)	(Inch-H ₂ O)	(dB(A))	(g)	
EE80201S1-000U-A99	○	12	130	1.56	3300	36.0	0.18	38.0	66.0	1
EE80201S2-000U-999	○	12	110	1.32	3000	33.0	0.16	35.0	66.0	2
EE80201S3-000U-999	○	12	83	1.00	2600	29.0	0.12	30.0	66.0	3
EE80202S1-000U-A99	○	24	64	1.54	3300	36.0	0.18	38.0	66.0	1
EE80202S2-000U-999	○	24	55	1.32	3000	33.0	0.16	35.0	66.0	2
EE80202S3-000U-999	○	24	44	1.06	2600	29.0	0.12	30.0	66.0	3

■ Air Flow-Static Pressure Characteristics

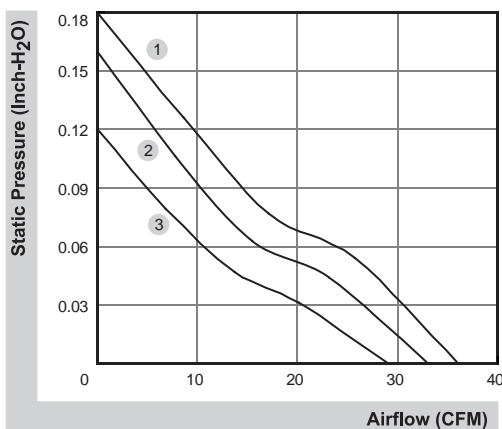

■ External dimensions(mm)

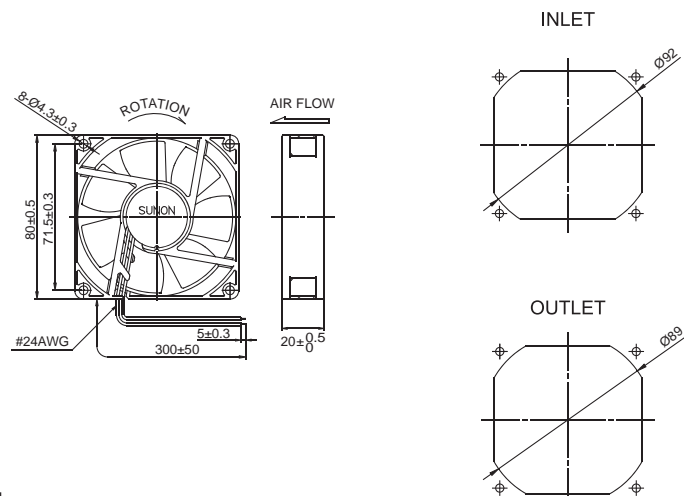

*All model could be customized. Please contact with Sunon Sales.

*Specifications are subject to change without notice. Please Visit SUNON website at <http://www.sunon.com> for update information.