

















# 92x92x25 mm

## 39.5~55.0 CFM



■ Specifications

	Bearing	Rating Voltage	Power Current	Power Consumption	Speed	Air Flow	Static Pressure	Noise	Weight	Curve
	● VAPO	(VDC)	(mA)	(WATTS)	(RPM)	(CFM)	(Inch-H <sub>2</sub> O)	(dB(A))	(g)	
ME92251VX-000U-A99	●	12	190	2.30	3400	55.0	0.21	37.5	89.0	1
ME92251V1-000U-A99	●	12	165	2.00	3000	51.5	0.15	34.0	96.0	2
ME92251V2-000U-A99	●	12	135	1.60	2700	45.0	0.13	32.0	94.0	3
ME92251V3-000U-A99	●	12	91	1.30	2400	39.5	0.10	28.0	94.0	4
ME92252VX-000U-A99	●	24	100	2.40	3400	55.0	0.21	37.5	89.0	1
ME92252V1-000U-A99	●	24	87	2.10	3000	51.5	0.15	34.0	94.0	2
ME92252V2-000U-A99	●	24	68	1.60	2700	45.0	0.13	32.0	94.0	3
ME92252V3-000U-A99	●	24	56	1.30	2400	39.5	0.10	28.0	94.0	4

Model	Bearing	Rating Voltage	Power Current	Power Consumption	Speed	Air Flow	Static Pressure	Noise	Weight	Curve
		(VDC)	(mA)	(WATTS)	(RPM)	(CFM)	(Inch-H <sub>2</sub> O)	(dB(A))	(g)	
EE92251BX-000U-A99		12	190	2.30	3400	55.0	0.21	37.5	89.0	1
EE92251B1-000U-A99		12	165	2.00	3000	51.5	0.15	34.0	94.0	2
EE92251B2-000U-999		12	135	1.60	2700	45.0	0.13	32.0	94.0	3
EE92251B3-000U-999		12	105	1.30	2400	39.5	0.10	28.0	94.0	4
EE92252BX-000U-A99		24	100	2.40	3400	55.0	0.21	37.5	89.0	1
EE92252B1-000U-A99		24	87	2.10	3000	51.5	0.15	34.0	94.0	2
EE92252B2-000U-999		24	70	1.70	2700	45.0	0.13	32.0	94.0	3
EE92252B3-000U-999		24	57	1.40	2400	39.5	0.10	28.0	94.0	4
EE92251S1-000U-A99		12	165	2.00	3000	51.5	0.15	34.0	94.0	2
EE92251S2-000U-999		12	135	1.60	2700	45.0	0.13	32.0	94.0	3
EE92251S3-000U-999		12	105	1.30	2400	39.5	0.10	28.0	94.0	4
EE92252S1-000U-A99		24	87	2.10	3000	51.5	0.15	34.0	94.0	2
EE92252S2-000U-999		24	72	1.70	2700	45.0	0.13	32.0	94.0	3
EE92252S3-000U-999		24	60	1.40	2400	39.5	0.10	28.0	94.0	4

■ Air Flow-Static Pressure Characteristics

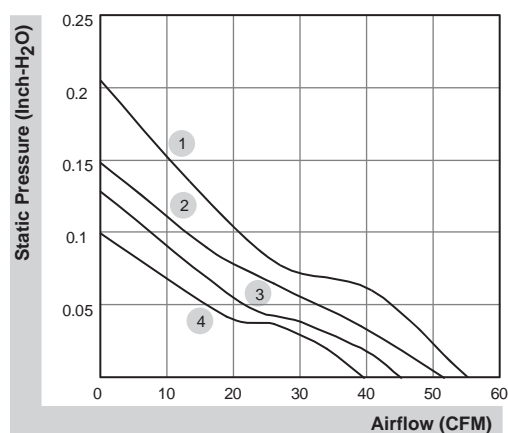

■ External dimensions(mm)

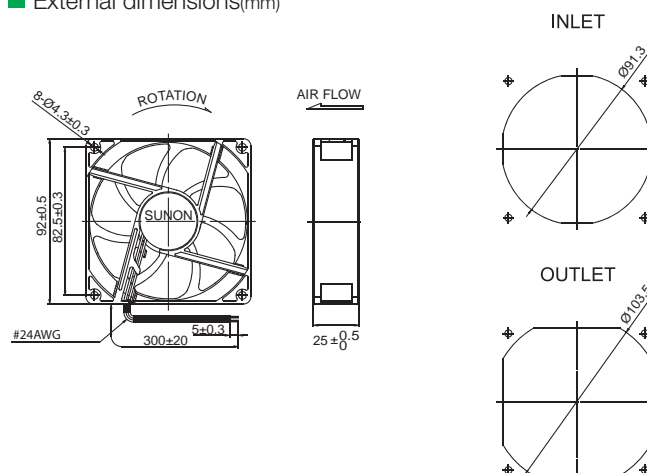

\*All model could be customized. Please contact with Sunon Sales.

\*Specifications are subject to change without notice. Please Visit SUNON website at <http://www.sunon.com> for update information.