

20x20x8 mm

1.3~1.6 CFM



■ Specifications

	Bearing	Rating Voltage	Power Current	Power Consumption	Speed	Air Flow	Static Pressure	Noise	Weight	Curve
	• VAPO	(VDC)	(mA)	(WATTS)	(RPM)	(CFM)	(Inch-H ₂ O)	(dB(A))	(g)	
MC20080V1-000U-A99	•	5	135	0.68	15000	1.6	0.22	23.0	4.64	1
MC20080V2-000U-A99	•	5	90	0.45	12000	1.3	0.15	21.0	4.64	2

■ Air Flow-Static Pressure Characteristics

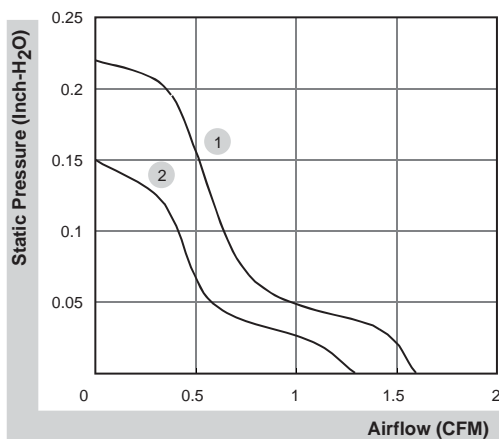

■ External dimensions(mm)

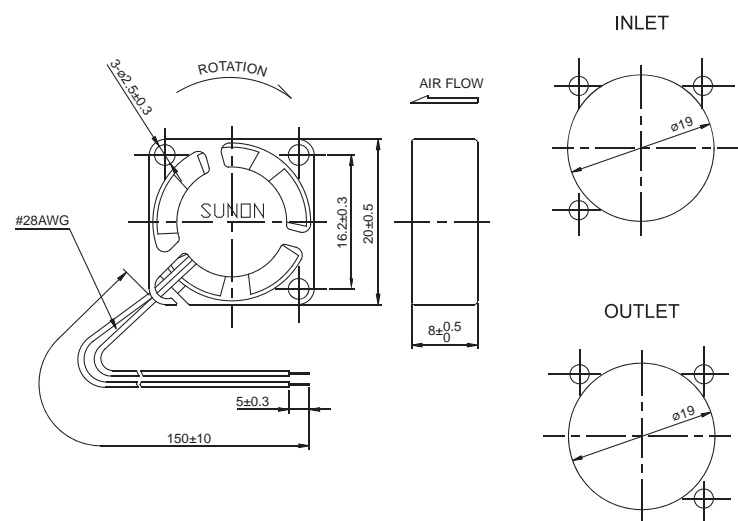

*All model could be customized. Please contact with Sunon Sales.

*Specifications are subject to change without notice. Please Visit SUNON website at <http://www.sunon.com> for update information.