

30x30x6 mm

3.7~4.9 CFM



■ Specifications

	Bearing	Rating Voltage	Power Current	Power Consumption	Speed	Air Flow	Static Pressure	Noise	Weight	Curve
	● VAPO	(VDC)	(mA)	(WATTS)	(RPM)	(CFM)	(Inch-H ₂ O)	(dB(A))	(g)	
MC30060V1-000U-A99	●	5	112	0.56	9500	4.9	0.14	28.0	6.0	1
MC30060V2-000U-A99	●	5	72	0.36	7500	3.7	0.09	24.0	6.0	2

■ Air Flow-Static Pressure Characteristics

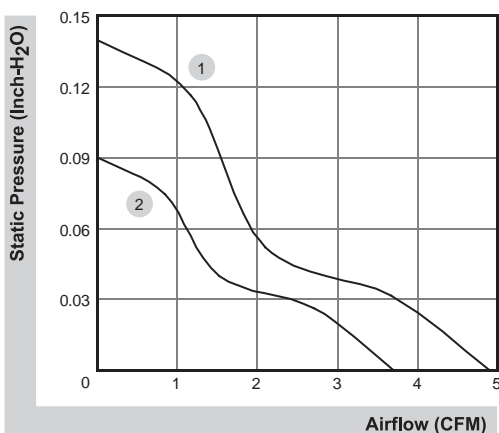

■ External dimensions(mm)

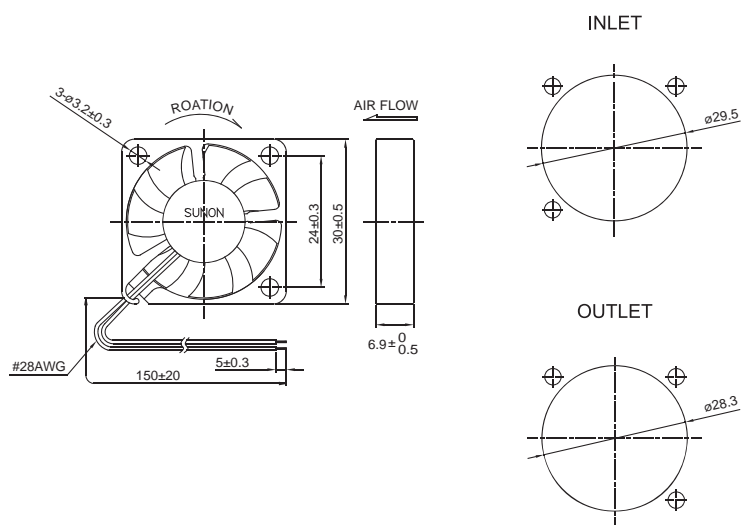

*All model could be customized. Please contact with Sunon Sales.

*Specifications are subject to change without notice. Please Visit SUNON website at <http://www.sunon.com> for update information.