

45x45x10 mm

9.2~11.0 CFM



■ Specifications

	Bearing	Rating Voltage	Power Current	Power Consumption	Speed	Air Flow	Static Pressure	Noise	Weight	Curve
	● VAPO	(VDC)	(mA)	(WATTS)	(RPM)	(CFM)	(Inch-H ₂ O)	(dB(A))	(g)	
ME45100V1-000U-A99	●	5	223	1.12	6000	11.0	0.17	32.0	16.0	2
MB45100V2-000U-A99	●	5	230	1.15	5000	9.2	0.12	27.0	19.0	4
ME45101V1-000U-A99	●	12	110	1.32	6500	11.8	0.18	32.5	16.0	1
MB45101V2-000U-A99	●	12	105	1.26	5000	9.2	0.12	27.0	18.5	4

Model	Bearing	Rating Voltage	Power Current	Power Consumption	Speed	Air Flow	Static Pressure	Noise	Weight	Curve
	○ 2BALL Sleeve	(VDC)	(mA)	(WATTS)	(RPM)	(CFM)	(Inch-H ₂ O)	(dB(A))	(g)	
EE45100S1-000U-999	○	5	260	1.30	6000	11.0	0.17	32.0	16.0	2
EB45100S2-000U-999	○	5	240	1.20	5000	9.2	0.12	27.0	19.0	4
EE45101S1-000U-999	○	12	110	1.32	5700	10.5	0.16	31.0	16.0	3
EB45101S2-000U-999	○	12	120	1.44	5000	9.2	0.12	27.0	18.5	4

■ Air Flow-Static Pressure Characteristics

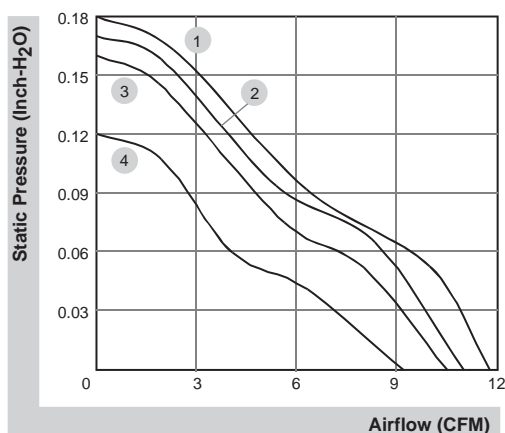

■ External dimensions(mm)

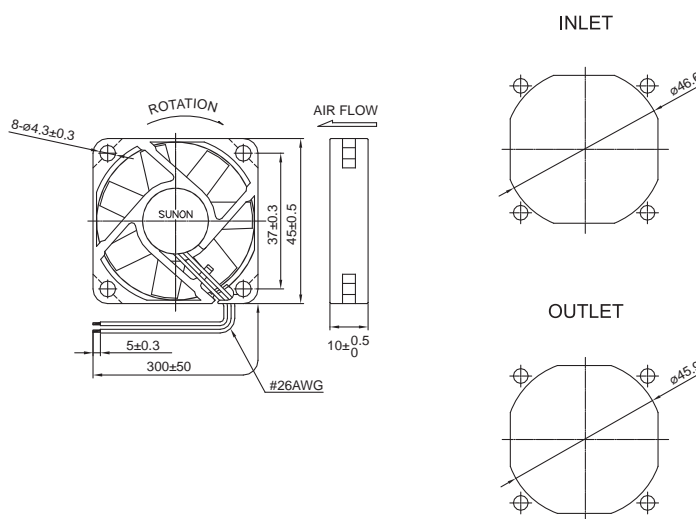

*All model could be customized. Please contact with Sunon Sales.

*Specifications are subject to change without notice. Please Visit SUNON website at <http://www.sunon.com> for update information.