

REAR VIEW

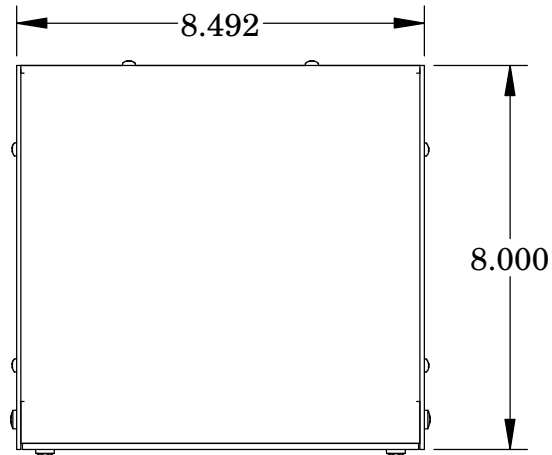

TOP VIEW

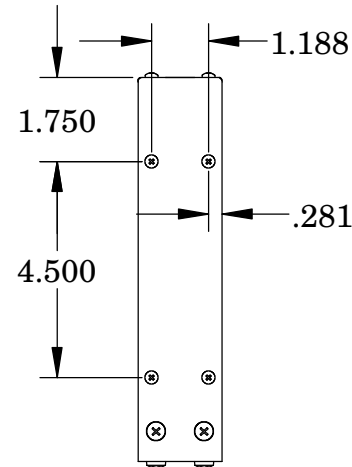

SIDE VIEW

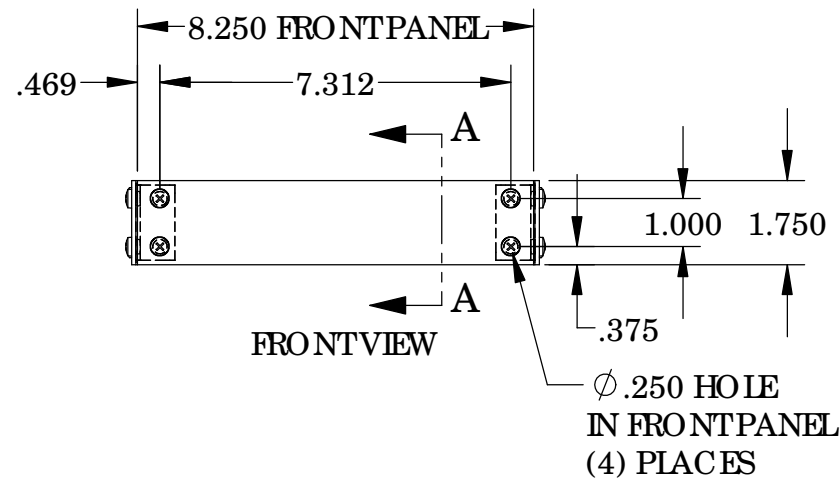
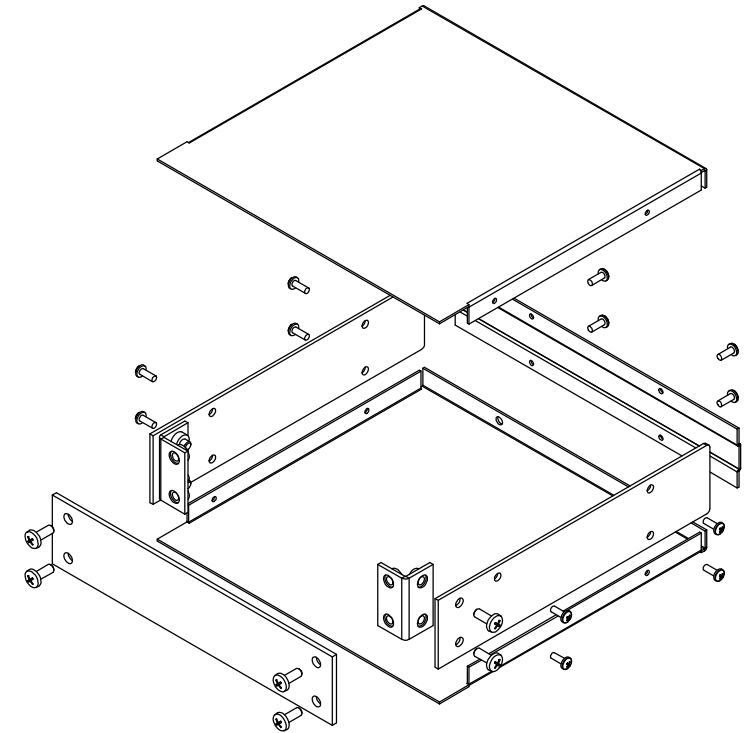

FRONT VIEW

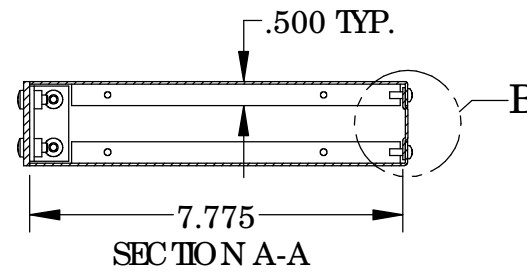

SECTION A-A

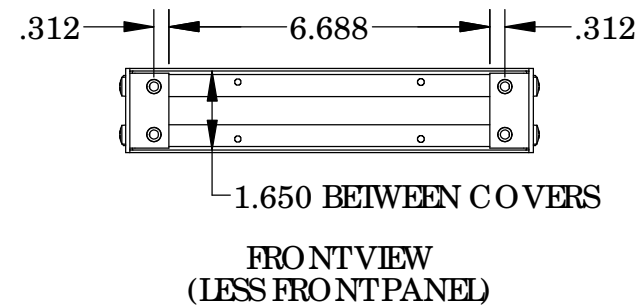

FRONT VIEW (LESS FRONT PANEL)

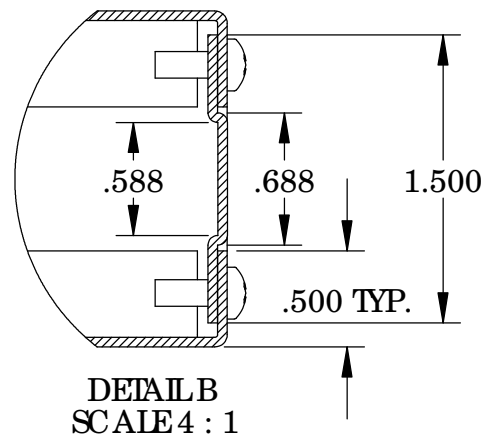

DETAIL B SCALE 4 : 1

UNIT SHIPPED UNASSEMBLED.

OPTIONAL SELF-ADHESIVE RUBBER FEET (SUPPLIED)

LOAD RATING: 25 LBS. MAX.

MATERIAL:

BACK & COVERS _____ 0.050 THICK ALUMINUM
 SIDES & INNER BRACKETS _____ 0.090 THICK ALUMINUM
 FRONT PANEL _____ 0.125 THICK ALUMINUM

FINISH:

BACK & COVERS _____ PREPAINTED SMOOTH WHITE
 SIDES _____ WHITE TEXTURED
 FRONT PANEL _____ NATURAL (OUTSIDE SURFACE TAPED WITH PVC)
 INNER BRACKETS _____ NATURAL
 FEET _____ BLACK