

UNIT SHIPPED UNASSEMBLED.

OUTER BRACKETS FOR MOUNTING IN STANDARD 19" WIDE CABINETS.

OPTIONAL SELF-ADHESIVE RUBBER FEET (SUPPLIED)

LOAD RATING: 25 LBS. MAX.

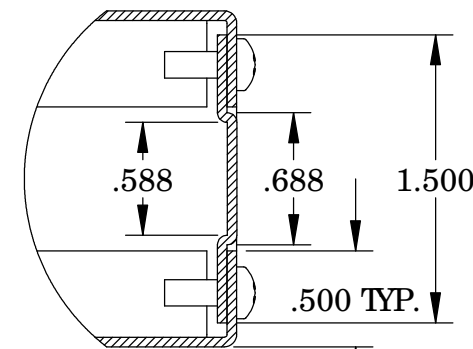
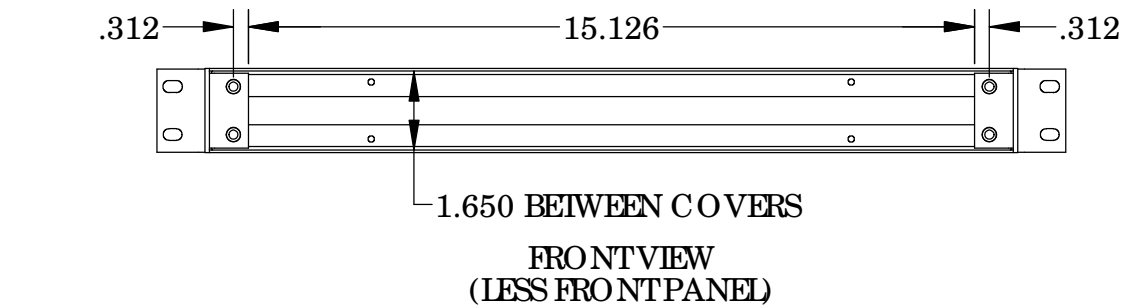
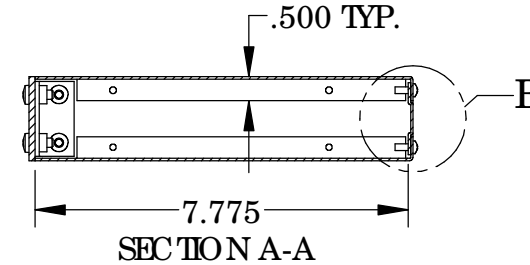
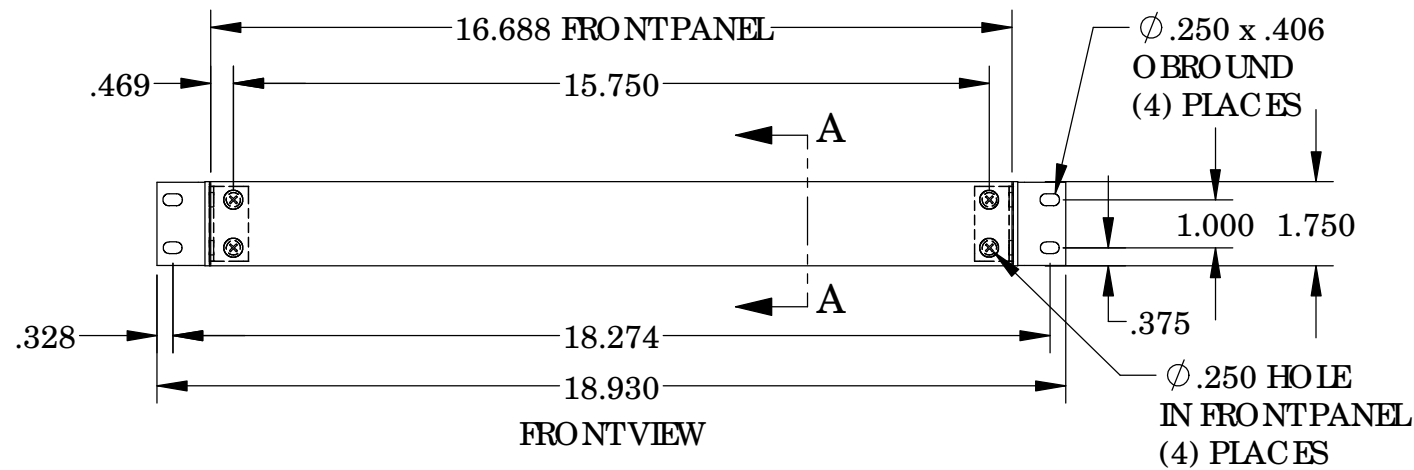
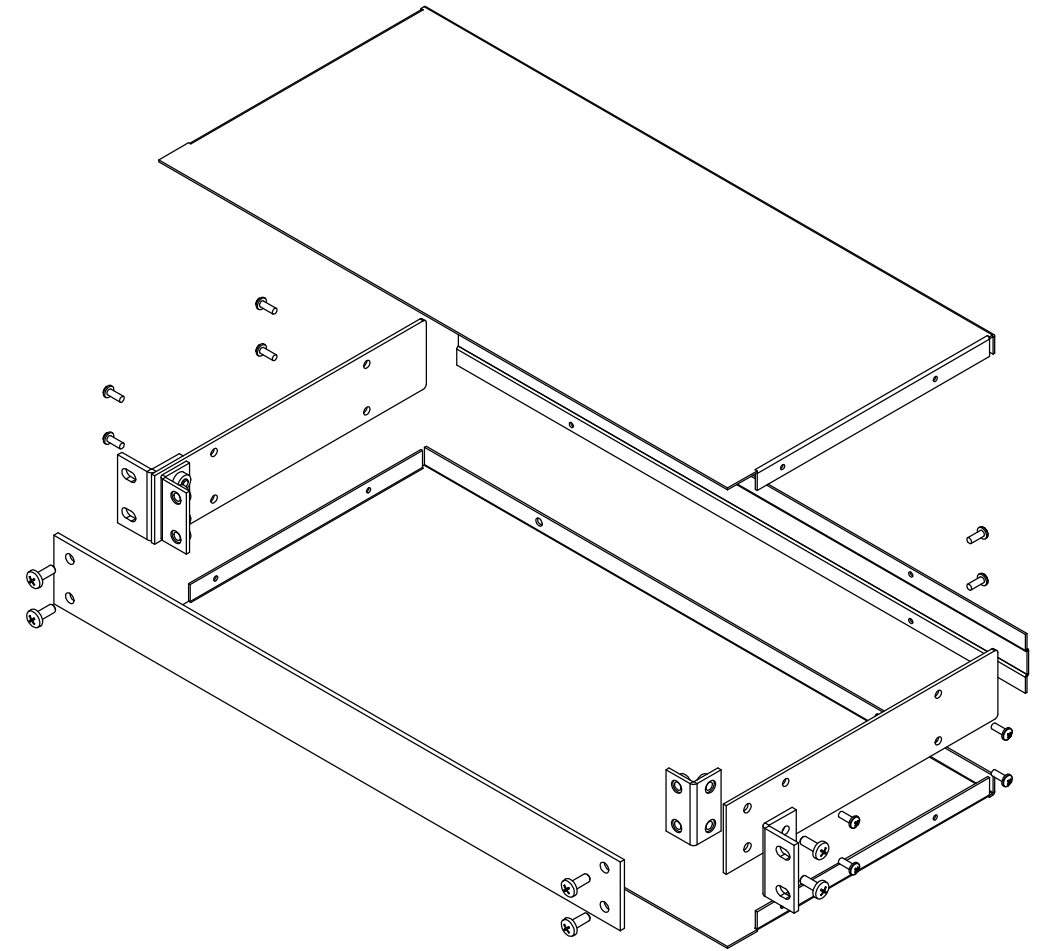
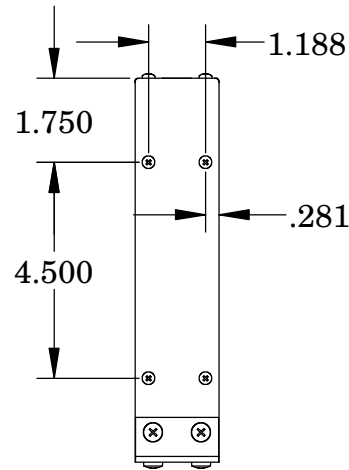
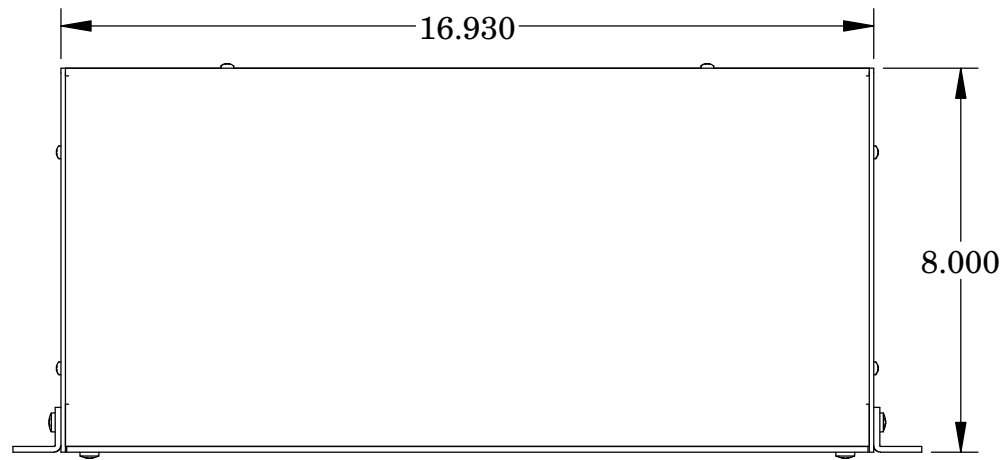

SCALE 4 : 1

MATERIAL:

- BACK & COVERS \_\_\_\_\_ 0.050 THICK ALUMINUM
- SIDES & INNER BRACKETS \_\_\_\_\_ 0.090 THICK ALUMINUM
- FRONT PANEL \_\_\_\_\_ 0.125 THICK ALUMINUM
- OUTER BRACKETS \_\_\_\_\_ 11 GA. C.R.S.

FINISH:

- BACK & COVERS \_\_\_\_\_ PREPAINTED SMOOTH WHITE
- SIDES & OUTER BRACKETS \_\_\_\_\_ WHITE TEXTURED
- FRONT PANEL \_\_\_\_\_ NATURAL (OUTSIDE SURFACE TAPED WITH PVC)
- INNER BRACKETS \_\_\_\_\_ NATURAL
- FEET \_\_\_\_\_ BLACK