

PART
NAME

NEMA SHEET METAL BOX

PART
No.

SNB-3749

REVISION
DATE

6-7-13

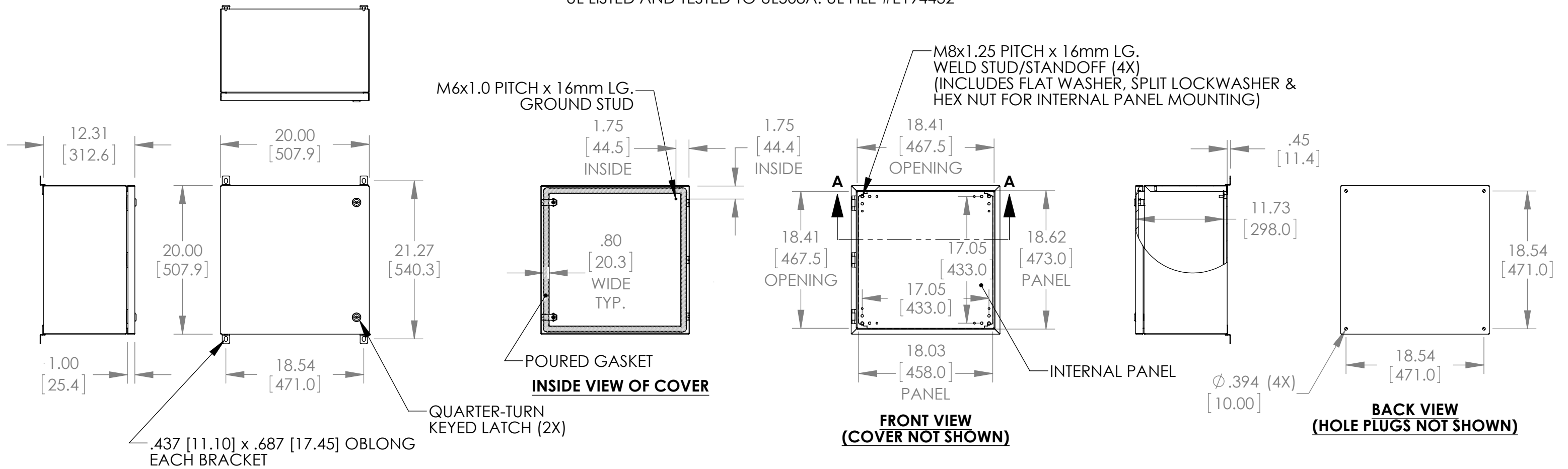
DESIGNED TO MEET NEMA 1, 2, 4, 4X, 12, 13 AND IP-66
UL LISTED AND TESTED TO UL508A. UL FILE #E194432

MATERIAL:
 BODY & COVER - 16 GA. [1.5mm] C.R.S.
 INTERNAL PANEL - 14 GA. [2.0mm] C.R.S.
 WALL MOUNTING BRACKETS - 14 GA. [2.0mm] TYPE 430 STAINLESS STEEL
 STRIKERS - 11 GA. STAINLESS STEEL 304
 HINGE PINS & WALL MOUNTING HARDWARE - TYPE 201 STAINLESS STEEL
 INTERNAL PANEL MOUNTING HARDWARE & GROUND STUD
 HARDWARE - PLAIN STEEL
 LATCHES - ZINC DIE CAST
 LATCH GASKET WASHER - BLACK ACRYLONITRILE-BUTADIENE RUBBER
 POURED GASKET - BLACK POLYURETHANE FOAM
 SEALING WASHERS - BLACK NEOPRENE
 HOLE PLUGS - LIGHT GRAY NEOPRENE

FINISH:
 BODY & COVER - LIGHT GRAY SMOOTH POWDER COAT
 INTERNAL PANEL, INTERNAL PANEL MOUNTING HARDWARE
 & GROUND STUD HARDWARE - CLEAR ZINC PLATED
 WALL MOUNTING BRACKETS, STRIKERS & HINGE PINS - NATURAL
 LATCHES - CHROME PLATED

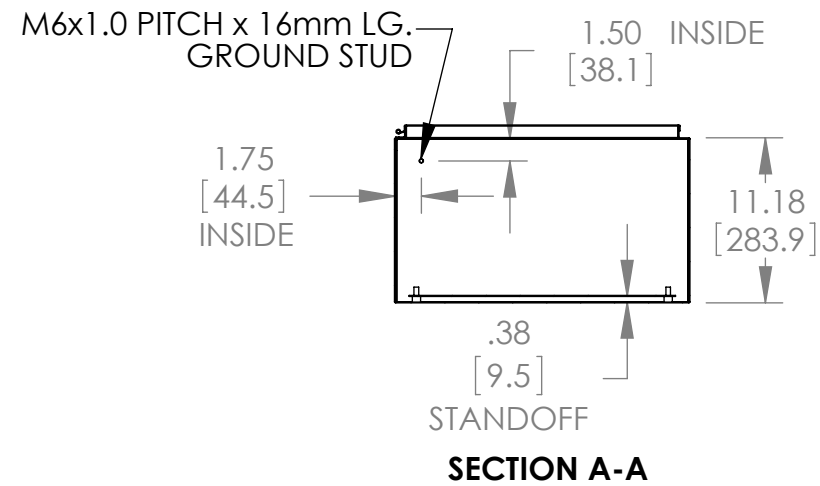

SUPPLIED WALL MOUNTING BRACKET KIT CONTAINS:
 QTY. (4) WALL MOUNTING BRACKETS
 QTY. (4) HEX HEAD BOLT M10x1.5 PITCH x 19.5mm LG.
 QTY. (8) SEALING WASHERS
 QTY. (4) FLAT WASHERS M10
 QTY. (4) SPLIT LOCKWASHERS M10
 QTY. (4) HEX NUTS M10x1.5

SUPPLIED GROUNDING KIT CONTAINS:
 QTY. (1) GROUND WIRE 14-16 GA. YELLOW/GREEN WITH RING TERMINAL (M6) AT EACH END
 QTY. (4) FLAT WASHER M6
 QTY. (2) SPLIT LOCKWASHER M6
 QTY. (2) HEX NUT M6x1.0

