

PART
NAME

JUNCTION BOX

PART
No.

JB-3957

REVISION
DATE

7-18-11

MATERIAL - 16 GA. [1.5mm] STEEL
FINISH - SMOOTH GRAY POWDERCOAT

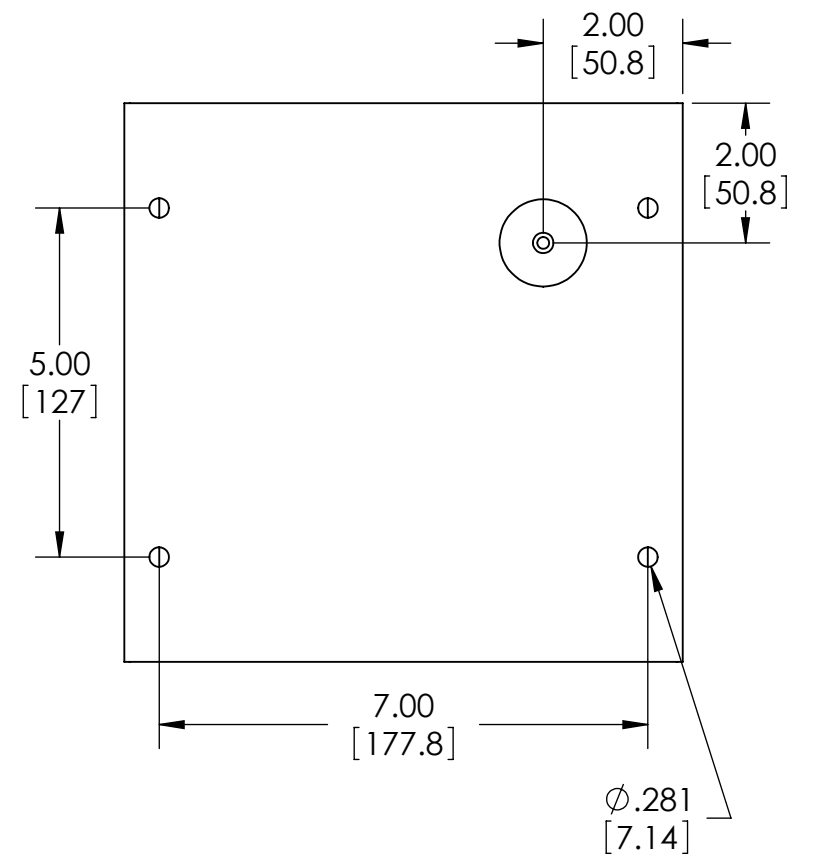
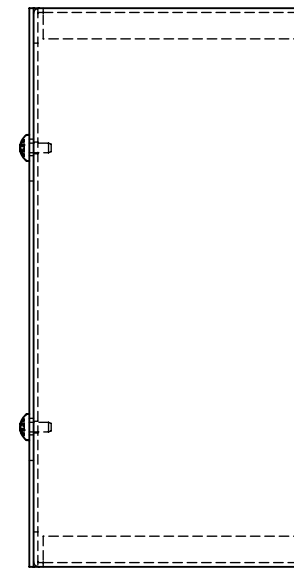
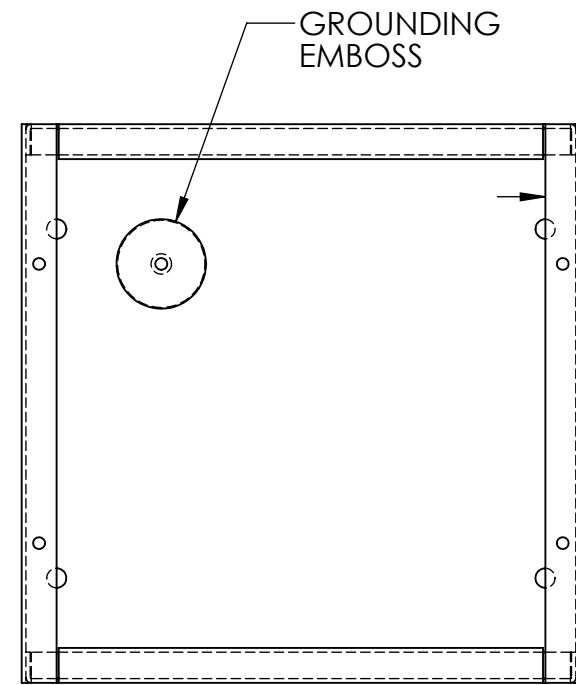
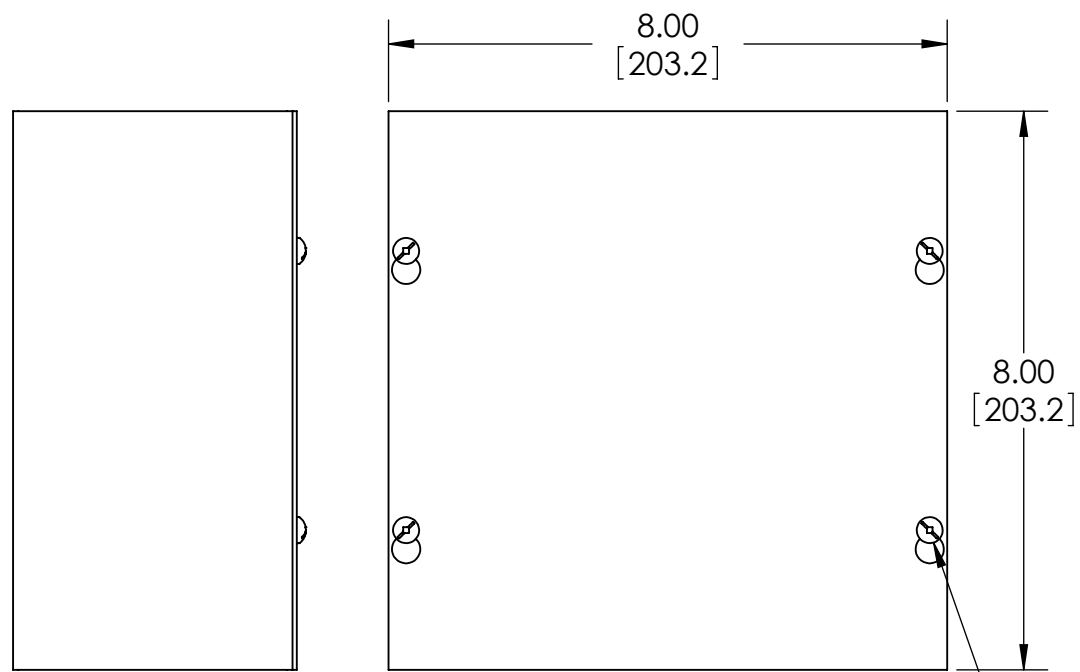
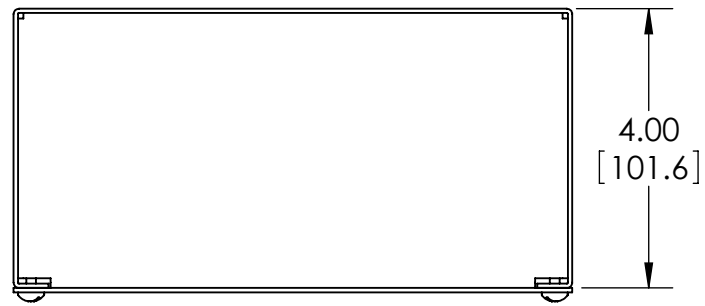
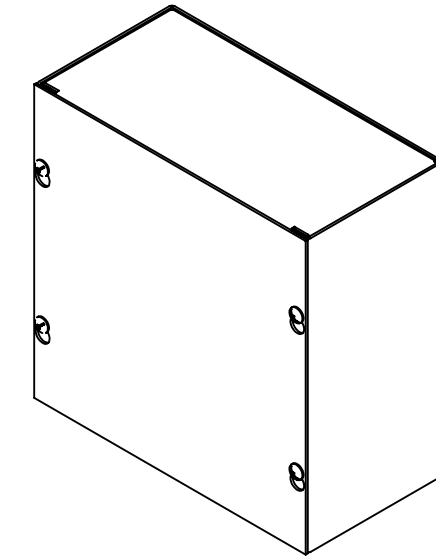

COVER REMOVED

SCREWS: #10-32 x .31"[8mm] LG.
MACHINE, PAN HEAD, SLOTTED/SQUARE
COMBINATION STYLE DRIVE, STEEL, ZINC PLATED.
(SUPPLIED FOR COVER MOUNTING AND
FOR GROUND POINT).

