

PART NAME

30.5mm PUSHBUTTON ENCLOSURE

PART No.

SPB-3923

REVISION DATE

1-31-11

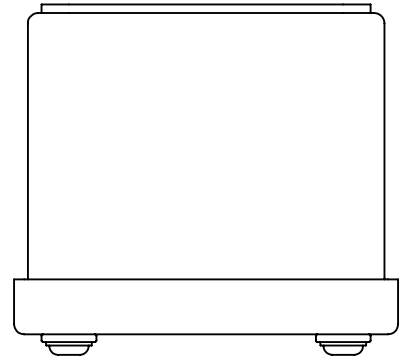

MATERIAL - 14 GA. [2.0mm] STEEL
FINISH - SMOOTH GRAY POWDERCOAT
UL LISTED TYPE DTOV2

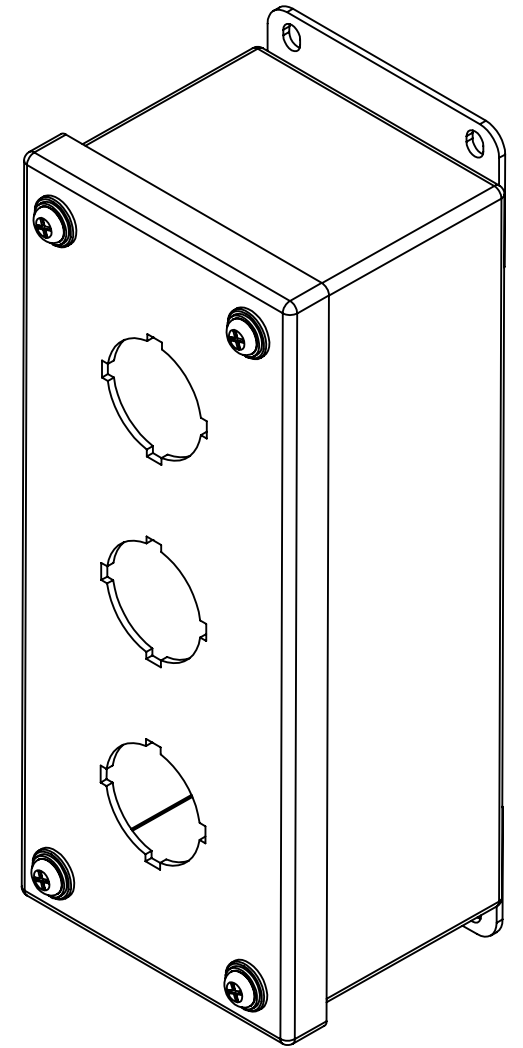
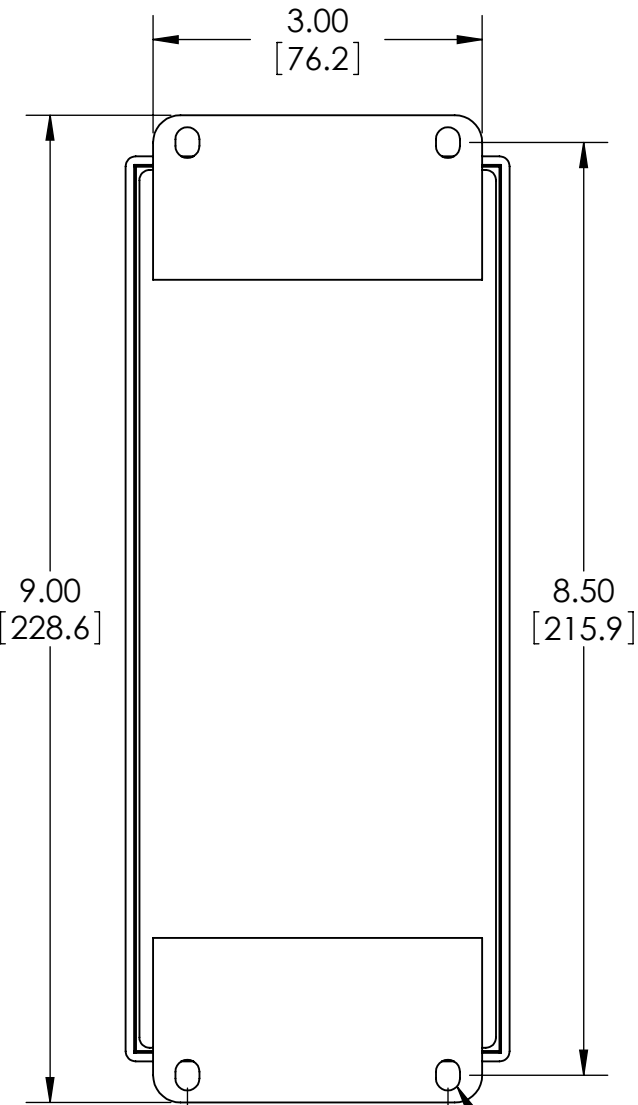
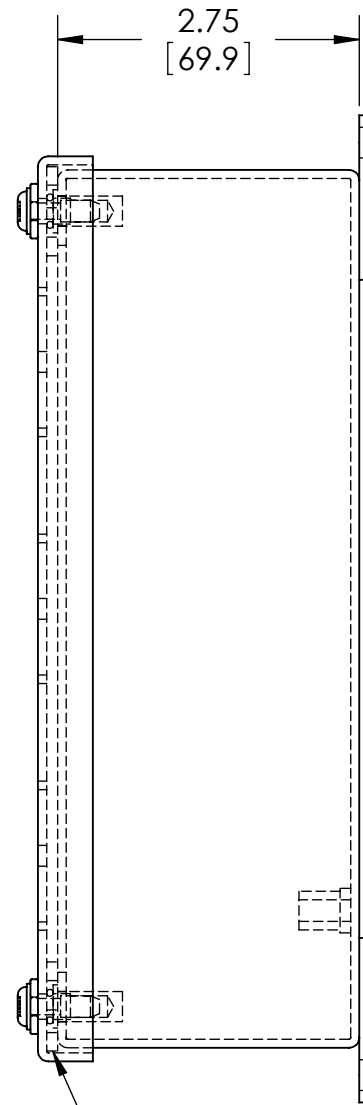
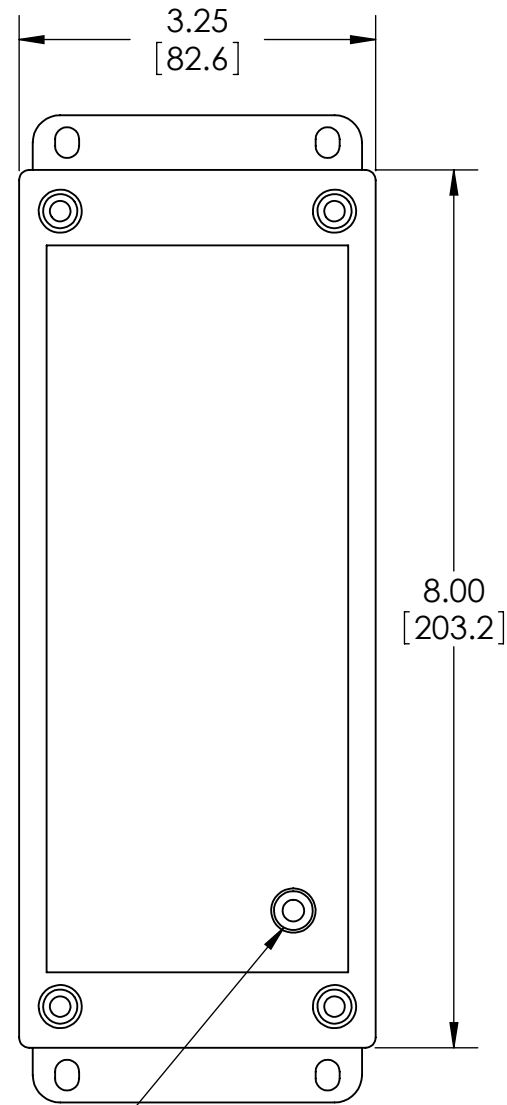
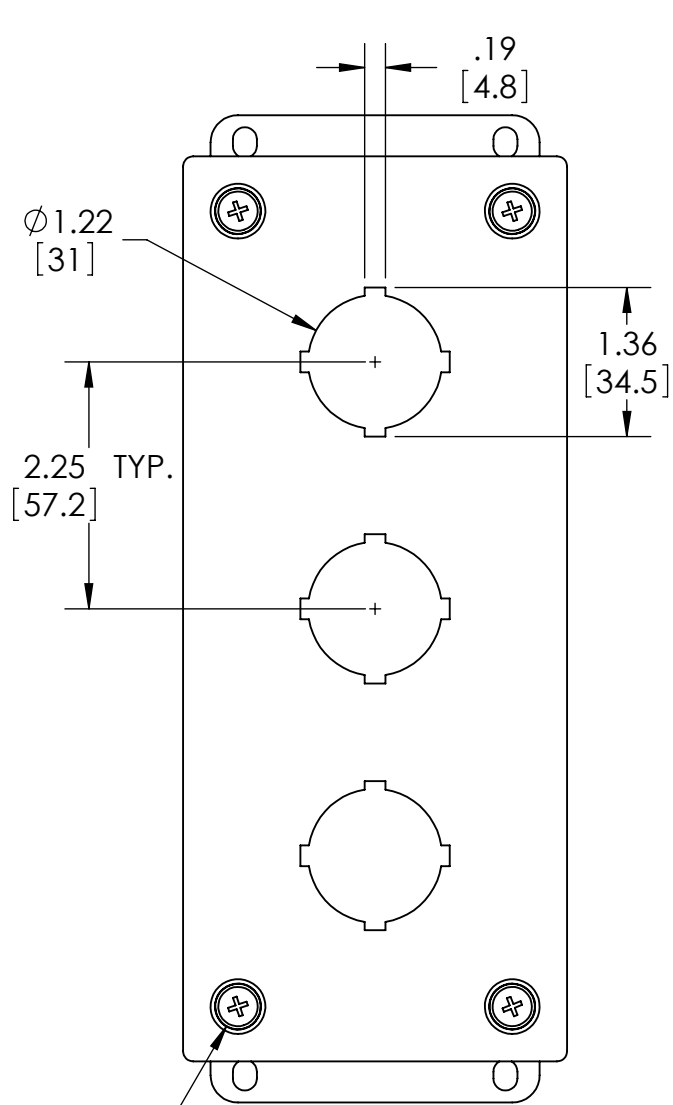

2.38 [60.3] .22 [5.6] x .28 [7.1] OBLONG

CAPTIVE SCREW M5x0.8 x 16mm LG., WASHER HEAD, PHILLIPS DRIVE, STEEL, ZINC PLATED, WITH SEALING WASHER, NEOPRENE, BLACK AND O-RING, BUNA-N, BLACK

COVER REMOVED
WELD STANDOFF M5x0.8 x 12mm LG. FOR GROUNDING [SUPPLIED WITH (1) SCREW M5x0.8 x 10mm LG., PAN HEAD, PHILLIPS DRIVE, STEEL, ZINC PLATED AND (1) LOCKWASHER, INTERNAL TOOTH, STEEL, ZINC PLATED]

ONE-PIECE DIE-CUT GASKET (.25[6.3] THK. PORON #4701-41-15250-04 - BLACK) INSIDE COVER.