

PART  
NAME

UTILIBOX (STYLE K)

PART  
No.

CU-1951

REV.  
DATE

MATERIAL: HIGH-IMPACT ABS  
(FLAMMABILITY RATING OF UL94-HB)  
FINISH: BLACK TEXTURED

ALL DIMENSIONS HAVE  $\pm 0.015$  TOLERANCE.

BOX FEATURES PRESS-FIT COVER AND  
THREE MOLDED-IN PROTRUDING WIRE/CABLE ENTRY POINTS.

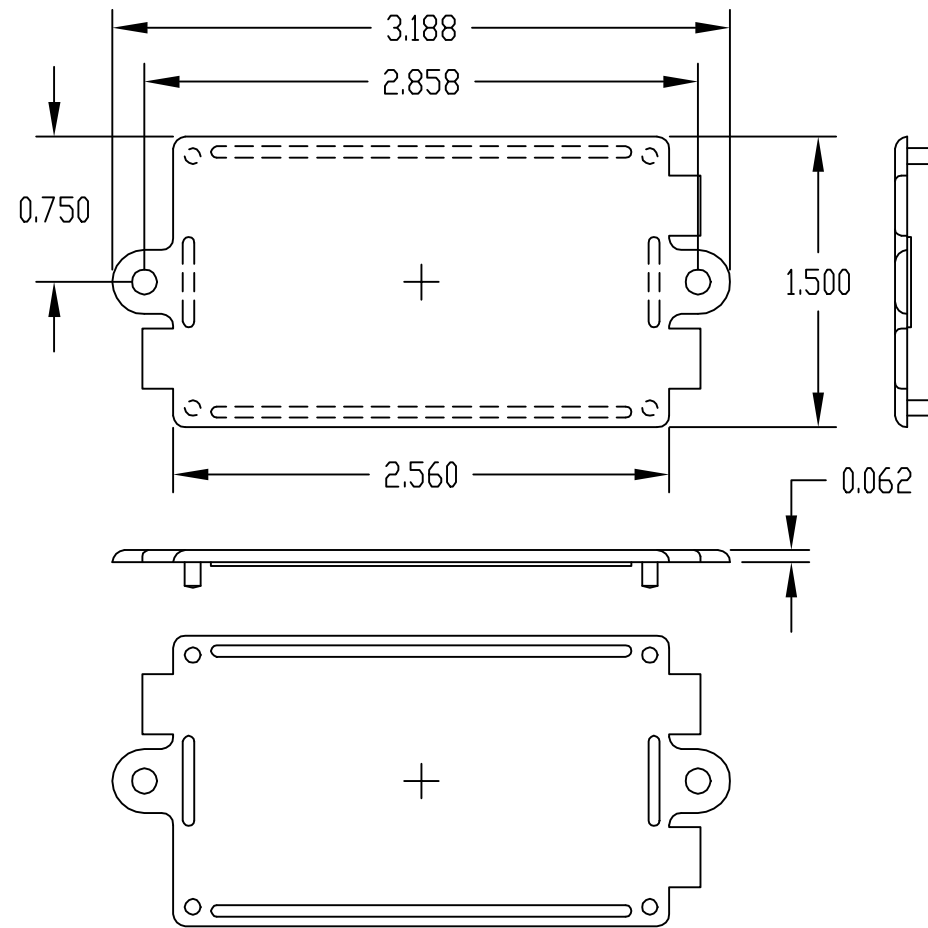
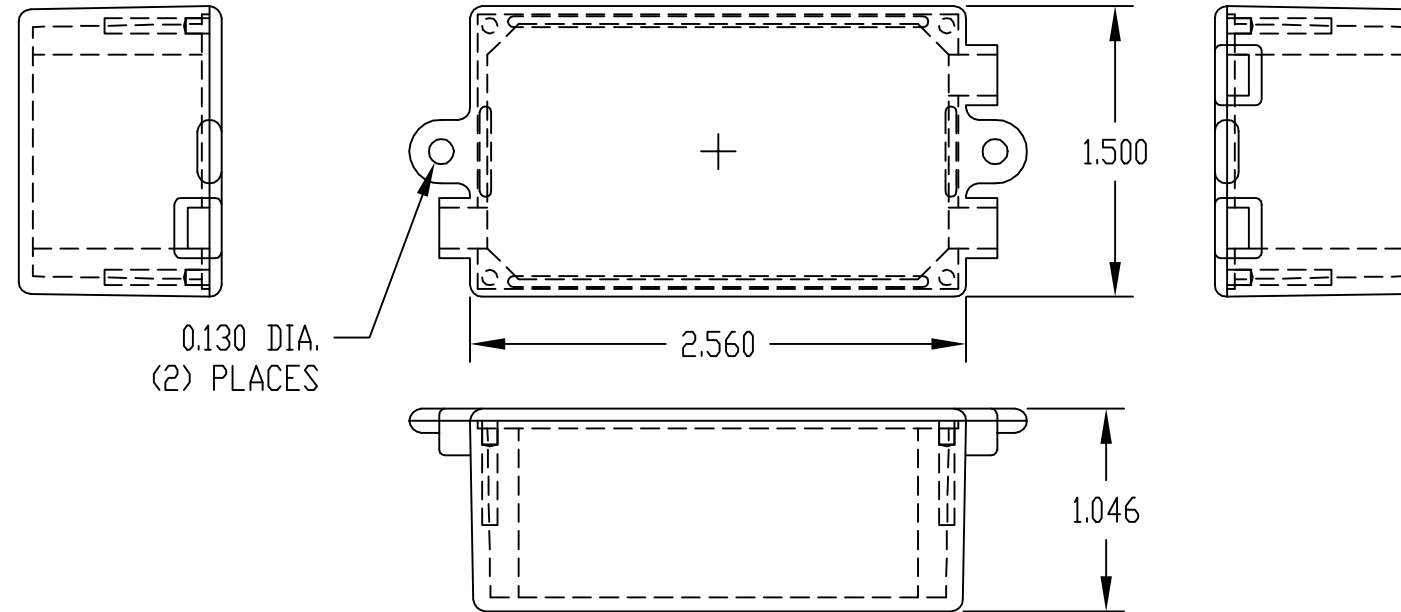

COVER

