

## NPN MEDIUM POWER MICROWAVE TRANSISTOR

### FEATURES

- HIGH DYNAMIC RANGE
- LOW IM DISTORTION: -40 dBc
- HIGH OUTPUT POWER : 27.5 dBm at TYP
- LOW NOISE: 1.5 dB TYP at 500 MHz
- LOW COST

### DESCRIPTION

The NE461 series of NPN silicon epitaxial bipolar transistors is designed for medium power applications requiring high dynamic range. This device exhibits an outstanding combination of high gain and low intermodulation distortion, as well as low noise figure. The NE461 series offers excellent performance and reliability at low cost through titanium, platinum, gold metallization system and direct nitride passivation of the surface of the chip. Devices are available in a low cost surface mount package (SOT-89) as well as in chip form.

NE46134  
TYPICAL OUTPUT POWER  
vs. INPUT POWER  
f = 1.0 GHz, I<sub>c</sub> = 100 mA

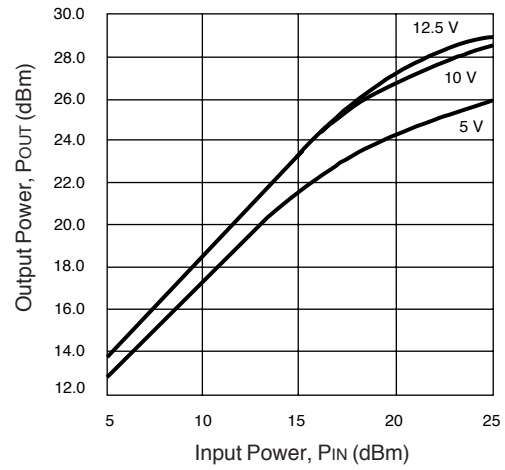

### ELECTRICAL CHARACTERISTICS (T<sub>A</sub> = 25°C)

PART NUMBER EIAJ <sup>1</sup> REGISTERED NUMBER PACKAGE OUTLINE			NE46100			NE46134 2SC4536 34		
SYMBOLS	PARAMETERS AND CONDITIONS	UNITS	MIN	TYP	MAX	MIN	TYP	MAX
f <sub>T</sub>	Gain Bandwidth Product at V <sub>CE</sub> = 10 V, I <sub>c</sub> = 100 mA	GHz		5.5			5.5	
NF <sub>MIN</sub>	Minimum Noise Figure <sup>3</sup> at V <sub>CE</sub> = 10 V, I <sub>c</sub> = 50 mA, 500 MHz V <sub>CE</sub> = 10 V, I <sub>c</sub> = 50 mA, 1 GHz	dB dB		1.5 2.0			1.5 2.0	
GL	Linear Gain, V <sub>CE</sub> = 12.5 V, I <sub>c</sub> = 100 mA, 2.0 GHz V <sub>CE</sub> = 12.5 V, I <sub>c</sub> = 100 mA, 1.0 GHz	dB dB		9.0			8.0	
IS <sub>21E</sub> <sup>2</sup>	Insertion Power Gain at 10 V, 50 mA, f = 1.0 GHz	dB		10.0		5.5	7.0	
h <sub>FE</sub>	DC Current Gain <sup>2</sup> at V <sub>CE</sub> = 10 V, I <sub>c</sub> = 50 mA		40		200	40		200
I <sub>CBO</sub>	Collector Cutoff Current at V <sub>CB</sub> = 20 V, I <sub>E</sub> = 0 mA	μA			5.0			5.0
I <sub>EBO</sub>	Emitter Cutoff Current at V <sub>EB</sub> = 2 V, I <sub>C</sub> = 0 mA	μA			5.0			5.0
P <sub>1dB</sub>	Output Power at 1 dB Compression, V <sub>CE</sub> = 12.5 V, I <sub>c</sub> = 100 mA, 2.0 GHz V <sub>CE</sub> = 12.5 V, I <sub>c</sub> = 100 mA, 1.0 GHz	dBm dBm	27.0				27.5	
IM <sub>3</sub>	Intermodulation Distortion, 10 V, 100 mA, F <sub>1</sub> = 1.0 GHz, F <sub>2</sub> = 0.99 GHz, Total P <sub>OUT</sub> = 20 dBm	dBc	-40.0			-40.0		
R <sub>TH</sub> (J-C)	Thermal Resistance (Junction to Case)	°C/W			30			32.5
R <sub>TH</sub> (J-A)	Thermal Resistance (Junction to Ambient)	°C/W					312.5	

Notes:

1. Electronic Industrial Association of Japan.
2. Pulsed: PW ≤ 350 ms, Duty Cycle ≤ 2%
3. RS = RL = 50 Ω untuned

**ABSOLUTE MAXIMUM RATINGS<sup>1</sup>** (T<sub>A</sub> = 25°C)

SYMBOLS	PARAMETERS	UNITS	RATINGS
V <sub>CB0</sub>	Collector to Base Voltage	V	30
V <sub>CE0</sub>	Collector to Emitter Voltage	V	15
V <sub>EBO</sub>	Emitter to Base Voltage	V	3
I <sub>C</sub>	Collector Current	mA	250
P <sub>T</sub>	Total Power Dissipation	W	3.75
	NE46100 <sup>2</sup>	W	2.0
T <sub>J</sub>	Junction Temperature	°C	200
	NE46134	°C	150
T <sub>STG</sub>	Storage Temperature	°C	-65 to +200
	NE46134	°C	-65 to +150

Notes:

1. Operation in excess of any one of these parameters may result in permanent damage.
2. Chip mounted on an infinite heat sink (see AN-1001 for handling instructions).
3. Packaged device mounted on 0.7 mm x 2.5 cm<sup>2</sup> double sided ceramic substrate (copper plating).

**NE46134**

**TYPICAL NOISE PARAMETERS** (T<sub>A</sub> = 25°C)

FREQ. (GHz)	NF <sub>OPT</sub> (dB)	G <sub>A</sub> (dB)	Γ <sub>OPT</sub>		RN/50
			MAG	ANG	
V <sub>CC</sub> = 10 V, I <sub>C</sub> = 50 mA					
0.5	1.5	13.5	0.34	-176	0.09

**TYPICAL PERFORMANCE CURVES** (T<sub>A</sub>=25°C)

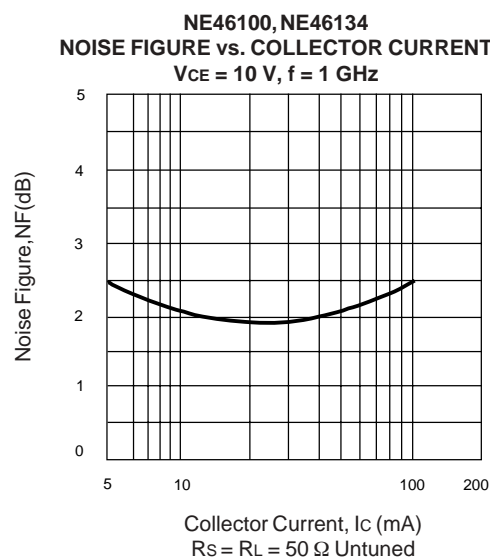
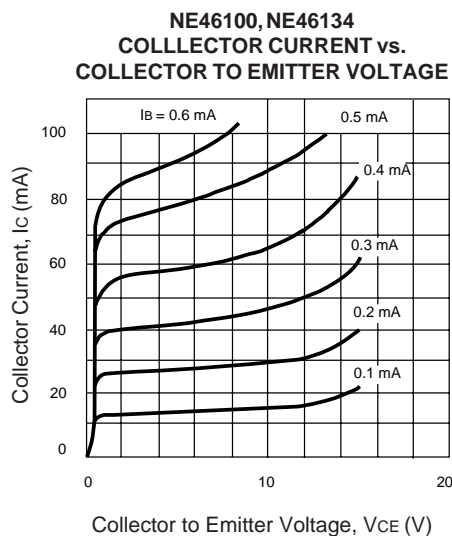
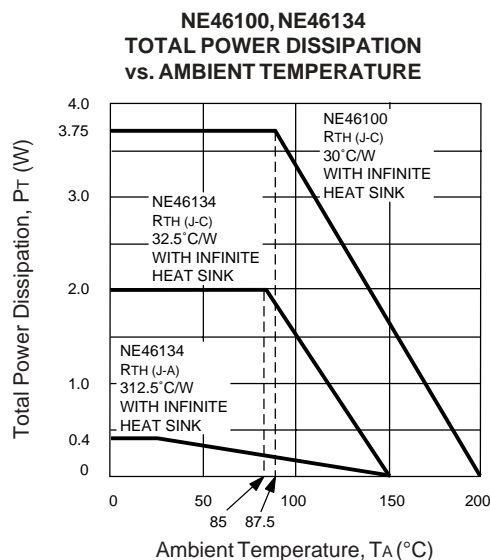
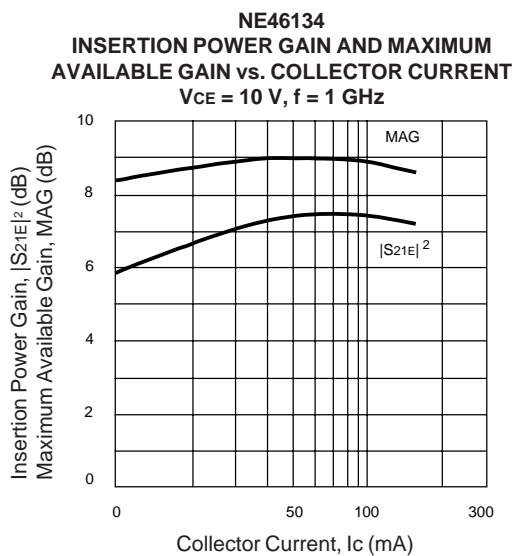

**TYPICAL PERFORMANCE CURVES** ( $T_A = 25^\circ\text{C}$ )

**NE46100, NE46134**  
**GAIN BANDWIDTH PRODUCT vs. COLLECTOR CURRENT**  
 $V_{CE} = 10\text{ V}$

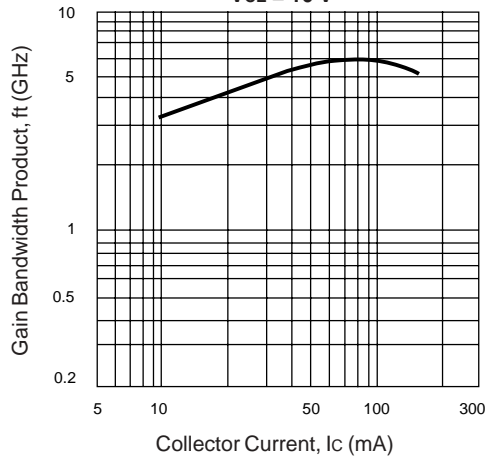

**NE46134**  
**TYPICAL OUTPUT POWER/INTERMODULATION DISTORTION vs. INPUT POWER**  
 $f = 1.0\text{ GHz}$ ,  $V_{CE} = 10\text{ V}$ ,  $I_C = 100\text{ mA}$   
**2 Tone Test  $F_1 = 1.0\text{ GHz}$ ,  $F_2 = 0.99\text{ GHz}$**

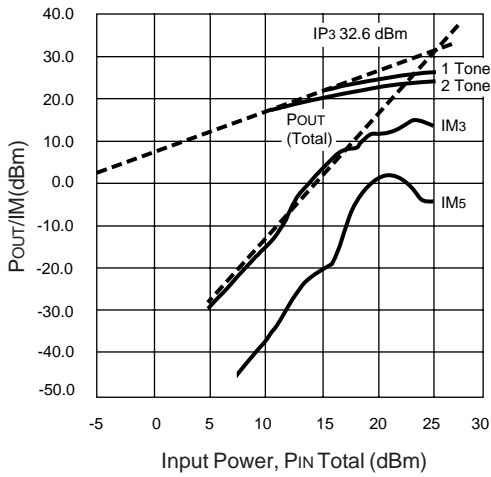

**NE46100, NE46134**  
**INTERMODULATION DISTORTION vs. COLLECTOR CURRENT**  
 $f = 1.0\text{ GHz}$ ,  $V_{CE} = 10\text{ V}$

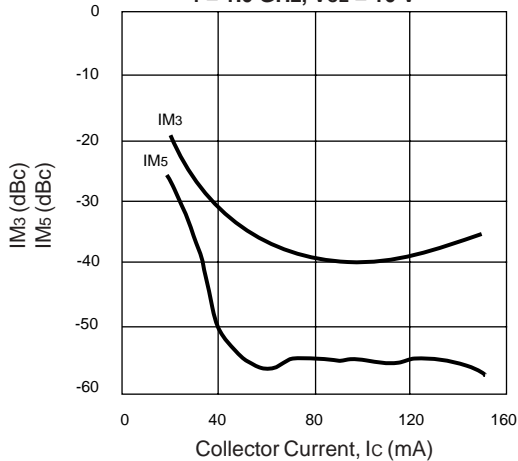

2 Tone Test  
 Total  $P_{IN} = 12.1\text{ dBm}$   
 $F_1 = 1.0\text{ GHz}$ ,  $F_2 = 0.99\text{ GHz}$

**NE46134**  
**3RD ORDER INTERMODULATION DISTORTION, 2ND ORDER INTERMODULATION DISTORTION (+ AND -) vs. COLLECTOR CURRENT**

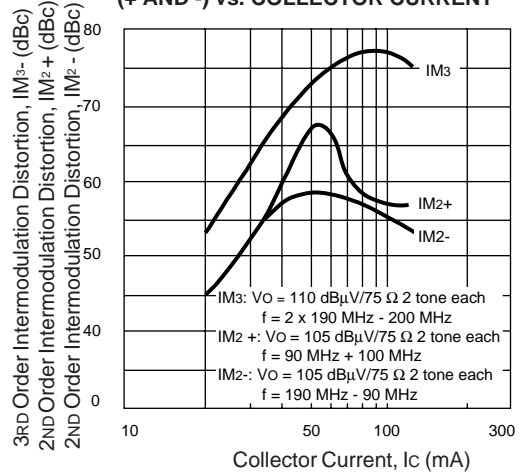

**NE46134**  
**TYPICAL OUTPUT POWER/INTERMODULATION DISTORTION vs. INPUT POWER**  
 $f = 1.0\text{ GHz}$ ,  $V_{CE} = 5\text{ V}$ ,  $I_C = 100\text{ mA}$   
**2 Tone Test  $F_1 = 1.0\text{ GHz}$ ,  $F_2 = 0.99\text{ GHz}$**

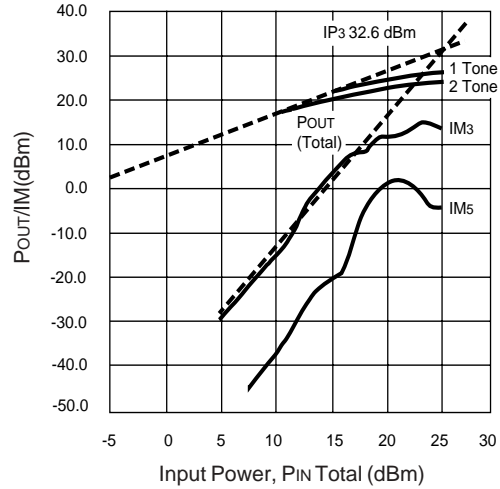

**NE46100, NE46134**  
**INTERMODULATION DISTORTION vs. COLLECTOR CURRENT**  
 $f = 1.0\text{ GHz}$ ,  $V_{CE} = 5\text{ V}$

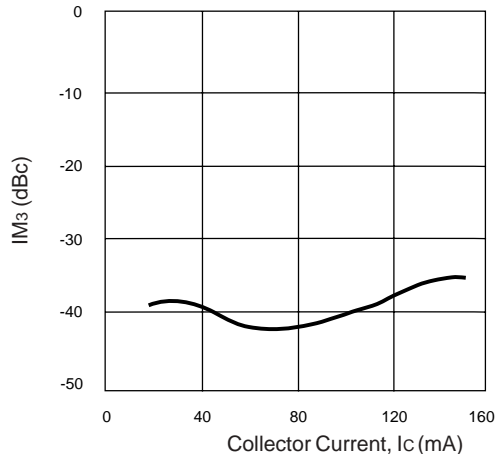

Total  $P_{IN} = 6.0\text{ dBm}$   
 $F_1 = 1.0\text{ GHz}$ ,  $F_2 = 0.99\text{ GHz}$   
 Note:  $IM_5 > \text{than } 58\text{ dB down from carrier}$  for measured currents greater than 40 mA.

**TYPICAL COMMON EMITTER SCATTERING PARAMETERS<sup>1</sup>** (T<sub>A</sub> = 25°C)

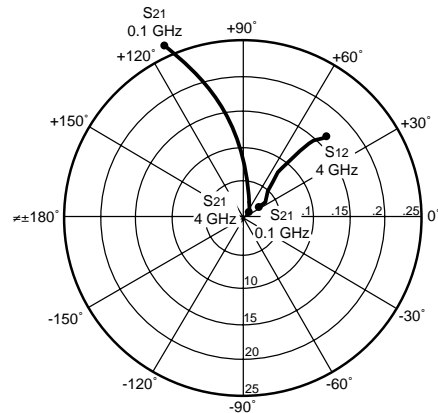
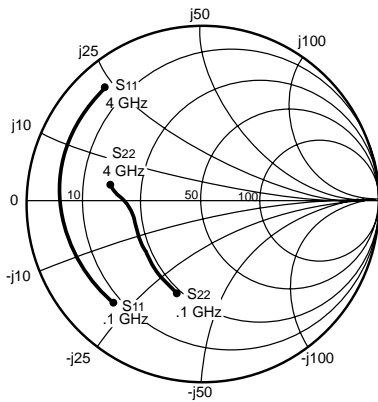

Coordinates in Ohms  
Frequency in GHz  
V<sub>CE</sub> = 5 V, I<sub>C</sub> = 50 mA

**NE46100**

V<sub>CE</sub> = 5 V, I<sub>C</sub> = 50 mA

FREQUENCY (MHz)	S <sub>11</sub>		S <sub>21</sub>		S <sub>12</sub>		S <sub>22</sub>		K	MAG <sup>2</sup> (dB)
	MAG	ANG	MAG	ANG	MAG	ANG	MAG	ANG		
100	0.778	-137	26.776	114	0.028	30	0.555	-102	0.16	29.8
200	0.815	-159	14.407	100	0.035	29	0.434	-135	0.36	26.2
500	0.826	-177	5.855	84	0.040	38	0.400	-162	0.75	21.7
800	0.827	176	3.682	76	0.052	43	0.402	-169	0.91	18.5
1000	0.826	173	2.963	71	0.058	47	0.405	-172	1.02	16.3
1200	0.825	170	2.441	66	0.064	47	0.412	-174	1.08	14.0
1400	0.820	167	2.111	61	0.069	47	0.413	-176	1.17	12.4
1600	0.828	165	1.863	57	0.078	54	0.426	-177	1.15	11.4
1800	0.827	162	1.671	53	0.087	50	0.432	-178	1.14	10.6
2000	0.828	159	1.484	49	0.093	50	0.431	-180	1.17	9.5
2500	0.822	153	1.218	39	0.11	48	0.462	177	1.18	7.8
3000	0.818	148	1.010	30	0.135	46	0.490	174	1.16	6.3
3500	0.824	142	0.876	21	0.147	44	0.507	170	1.16	5.3
4000	0.812	137	0.762	13	0.168	38	0.535	167	1.14	4.3

**V<sub>CE</sub> = 5 V, I<sub>C</sub> = 100 mA**

100	0.778	-144	27.669	111	0.027	35	0.523	-114	0.27	30.2
200	0.820	-164	14.559	97	0.029	29	0.445	-144	0.42	27.0
500	0.832	-179	5.885	84	0.035	38	0.435	-166	0.81	22.2
800	0.833	175	3.691	76	0.048	45	0.435	-173	0.95	18.8
1000	0.831	172	2.980	71	0.056	51	0.437	-176	1.05	16.0
1200	0.836	169	2.464	67	0.061	52	0.432	-178	1.11	14.0
1400	0.829	166	2.121	61	0.072	53	0.447	-180	1.12	12.6
1600	0.831	164	1.867	58	0.080	54	0.445	179	1.14	11.4
1800	0.827	161	1.671	54	0.090	53	0.460	178	1.14	10.4
2000	0.830	159	1.499	49	0.096	52	0.456	176	1.15	9.6
2500	0.831	153	1.228	40	0.115	51	0.479	173	1.15	8.0
3000	0.821	147	1.018	31	0.134	48	0.504	170	1.18	6.3
3500	0.820	142	0.881	23	0.155	42	0.516	167	1.14	5.3
4000	0.812	136	0.779	14	0.170	41	0.543	164	1.16	4.2

Notes:

1. S-Parameters include Bond wires.

Base: Total 1 wire, 1 per Bond Pad, 0.0259" (658 μm) long each wire.

Collector: Total 1 wire, 1 per Bond Pad, 0.0182" (463 μm) long each wire.

Emitter: Total 2 wires, 1 per side, 0.0224" (569 μm) long each wire.

Wire: 0.0007" (17.8 μm) dia., gold.

2. Gain Calculations:

$$MAG = \frac{|S_{21}|}{|S_{12}|} \left( K \pm \sqrt{K^2 - 1} \right). \text{ When } K \leq 1, \text{ MAG is undefined and MSG values are used. } MSG = \frac{|S_{21}|}{|S_{12}|}, K = \frac{1 + |\Delta|^2 - |S_{11}|^2 - |S_{22}|^2}{2 |S_{12} S_{21}|}, \Delta = S_{11} S_{22} - S_{21} S_{12}$$

MAG = Maximum Available Gain

MSG = Maximum Stable Gain

**TYPICAL COMMON EMITTER SCATTERING PARAMETERS<sup>1</sup>** ( $T_A = 25^\circ\text{C}$ )

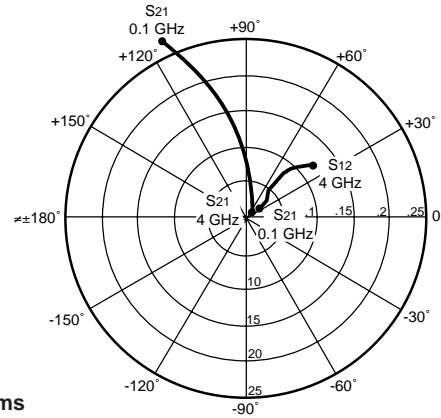
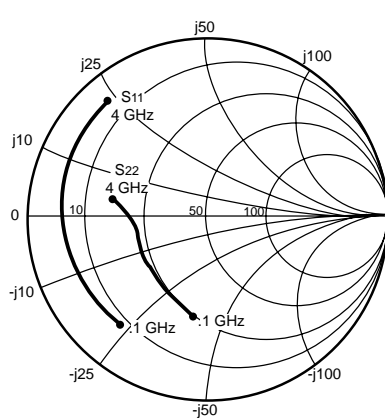

Coordinates in Ohms  
Frequency in GHz  
 $V_{CE} = 8\text{ V}, I_C = 50\text{ mA}$

**NE46100**  
 $V_{CE} = 8\text{ V}, I_C = 50\text{ mA}$

FREQUENCY (MHz)	S <sub>11</sub>		S <sub>21</sub>		S <sub>12</sub>		S <sub>22</sub>		K	MAG <sup>2</sup> (dB)
	MAG	ANG	MAG	ANG	MAG	ANG	MAG	ANG		
100	0.773	-133	27.779	115	0.031	30	0.538	-99	0.20	29.5
200	0.808	-157	15.007	100	0.033	30	0.428	-132	0.36	26.6
500	0.824	-176	6.118	85	0.041	35	0.388	-160	0.70	21.8
800	0.823	177	3.841	76	0.050	42	0.388	-168	0.91	18.8
1000	0.822	173	3.095	71	0.060	50	0.388	-171	0.99	17.2
1200	0.824	170	2.570	67	0.065	48	0.389	-173	1.05	14.6
1400	0.820	167	2.201	61	0.075	46	0.395	-175	1.06	13.2
1600	0.825	165	1.937	57	0.080	49	0.410	-176	1.09	12.0
1800	0.822	162	1.747	53	0.084	48	0.416	-177	1.15	10.9
2000	0.821	160	1.551	49	0.095	50	0.421	-179	1.15	9.8
2500	0.816	154	1.267	39	0.116	50	0.449	177	1.16	8.0
3000	0.817	148	1.051	30	0.128	45	0.474	175	1.17	6.7
3500	0.817	143	0.910	22	0.154	45	0.496	171	1.12	5.6
4000	0.807	137	0.800	13	0.169	40	0.527	168	1.13	4.6

**V<sub>CE</sub> = 8 V, I<sub>C</sub> = 100 mA**

100	0.771	-141	28.901	111	0.025	27	0.507	-109	0.23	30.6
200	0.816	-162	15.323	98	0.028	23	0.434	-142	0.38	27.4
500	0.823	-177	6.183	84	0.038	36	0.417	-165	0.76	22.1
800	0.822	176	3.889	76	0.047	48	0.419	-172	1.01	18.7
1000	0.824	172	3.124	71	0.057	49	0.418	-175	1.02	16.5
1200	0.822	169	2.605	67	0.064	54	0.422	-177	1.09	14.2
1400	0.816	166	2.223	62	0.073	56	0.426	-178	1.15	12.5
1600	0.821	164	1.962	58	0.079	54	0.435	180	1.15	11.6
1800	0.823	161	1.751	54	0.088	54	0.443	179	1.14	10.7
2000	0.823	159	1.563	50	0.097	55	0.438	177	1.17	9.6
2500	0.816	153	1.292	40	0.117	51	0.462	174	1.16	8.0
3000	0.814	148	1.061	31	0.134	48	0.491	171	1.18	6.5
3500	0.820	142	0.927	23	0.154	45	0.501	168	1.12	5.7
4000	0.807	137	0.814	15	0.170	41	0.529	165	1.15	4.4

**V<sub>CE</sub> = 10 V, I<sub>C</sub> = 50 mA**

100	0.780	-132	28.079	115	0.029	46	0.548	-99	0.21	29.8
200	0.809	-156	15.218	100	0.033	29	0.425	-131	0.34	26.7
500	0.819	-175	6.206	85	0.041	34	0.387	-159	0.70	21.8
800	0.817	177	3.888	76	0.048	42	0.386	-168	0.96	19.4
1000	0.821	174	3.136	71	0.060	48	0.385	-170	0.97	17.2
1200	0.821	171	2.596	67	0.063	47	0.388	-173	1.07	14.5
1400	0.814	168	2.236	62	0.068	53	0.394	-174	1.19	12.6
1600	0.819	165	1.976	58	0.075	50	0.401	-176	1.17	11.7
1800	0.816	162	1.769	53	0.084	51	0.413	-178	1.17	10.7
2000	0.819	160	1.565	49	0.094	49	0.416	-179	1.15	9.8
2500	0.815	154	1.290	39	0.116	51	0.439	178	1.14	8.2
3000	0.814	148	1.072	30	0.128	46	0.468	175	1.18	6.7
3500	0.819	143	0.920	22	0.150	44	0.488	173	1.12	5.8
4000	0.806	137	0.803	13	0.168	40	0.519	168	1.14	4.5

See notes on previous page.

# NE46100, NE46134

## TYPICAL COMMON EMITTER SCATTERING PARAMETERS<sup>1</sup> (T<sub>A</sub> = 25°C)

### NE46100

V<sub>CE</sub> = 10 V, I<sub>C</sub> = 100 mA

FREQUENCY (MHz)	S <sub>11</sub>		S <sub>21</sub>		S <sub>12</sub>		S <sub>22</sub>		K	MAG <sup>2</sup> (dB)
	MAG	ANG	MAG	ANG	MAG	ANG	MAG	ANG		
100	0.791	-139	29.278	112	0.027	30	0.508	-109	0.22	30.4
200	0.809	-161	15.503	98	0.027	32	0.433	-140	0.43	27.5
500	0.822	-177	6.280	84	0.037	43	0.414	-165	0.81	22.3
800	0.815	176	3.939	76	0.046	48	0.408	-171	1.02	18.5
1000	0.819	173	3.176	71	0.055	50	0.411	-174	1.05	16.2
1200	0.818	170	2.621	67	0.064	54	0.412	-176	1.11	14.1
1400	0.814	167	2.255	62	0.070	52	0.418	-178	1.16	12.7
1600	0.821	164	1.990	58	0.078	52	0.430	-180	1.14	11.8
1800	0.823	161	1.786	54	0.090	53	0.434	179	1.11	11.0
2000	0.819	159	1.585	50	0.097	52	0.429	177	1.15	9.8
2500	0.816	153	1.304	40	0.113	51	0.458	174	1.18	8.1
3000	0.812	148	1.085	31	0.139	47	0.484	171	1.13	6.7
3500	0.813	142	0.937	23	0.153	45	0.501	168	1.14	5.6
4000	0.802	137	0.824	15	0.168	42	0.520	165	1.18	4.3

V<sub>CE</sub> = 12.5 V, I<sub>C</sub> = 50 mA

100	0.759	-129	28.230	116	0.032	30	0.543	-96	0.21	29.5
200	0.806	-155	15.378	101	0.035	31	0.420	-130	0.35	26.4
500	0.815	-175	6.261	85	0.041	34	0.380	-159	0.71	21.9
800	0.813	178	3.926	76	0.052	44	0.379	-167	0.91	18.8
1000	0.814	174	3.179	71	0.058	45	0.375	-171	1.00	17.1
1200	0.816	171	2.629	67	0.067	47	0.382	-172	1.03	14.8
1400	0.810	168	2.266	62	0.071	46	0.385	-174	1.12	12.9
1600	0.817	165	1.993	58	0.079	47	0.400	-175	1.11	12.0
1800	0.816	163	1.770	53	0.087	49	0.408	-176	1.13	10.9
2000	0.817	160	1.592	49	0.090	51	0.408	-178	1.20	9.8
2500	0.811	154	1.301	40	0.109	50	0.441	179	1.20	8.0
3000	0.809	149	1.084	30	0.131	46	0.459	176	1.17	6.7
3500	0.811	143	0.934	22	0.150	45	0.482	172	1.15	5.6
4000	0.803	137	0.816	13	0.166	42	0.514	169	1.17	4.4

V<sub>CE</sub> = 12.5 V, I<sub>C</sub> = 100 mA

100	0.785	-138	29.375	112	0.027	25	0.510	-109	0.21	30.4
200	0.804	-160	15.593	98	0.030	32	0.421	-140	0.43	27.1
500	0.814	-177	6.318	84	0.040	42	0.401	-164	0.78	22.0
800	0.809	176	3.951	76	0.048	48	0.398	-171	1.02	18.3
1000	0.815	173	3.193	71	0.057	52	0.400	-174	1.05	16.1
1200	0.813	170	2.656	67	0.060	53	0.403	-177	1.17	14.0
1400	0.811	167	2.264	62	0.073	51	0.411	-178	1.13	12.7
1600	0.818	164	1.997	58	0.076	55	0.416	-180	1.19	11.6
1800	0.814	162	1.797	54	0.090	54	0.421	180	1.14	10.7
2000	0.813	160	1.613	49	0.094	50	0.424	178	1.18	9.8
2500	0.805	154	1.316	40	0.113	52	0.442	175	1.22	7.9
3000	0.813	148	1.091	31	0.133	46	0.470	172	1.15	6.7
3500	0.807	142	0.948	23	0.156	45	0.481	169	1.15	5.5
4000	0.802	137	0.826	14	0.164	40	0.510	166	1.19	4.4

#### Notes:

##### 1. S-Parameters include Bond wires.

Base: Total 1 wire, 1 per Bond Pad, 0.0259" (658 μm) long each wire.

Collector: Total 1 wire, 1 per Bond Pad, 0.0182" (463 μm) long each wire.

Emitter: Total 2 wires, 1 per side, 0.0224" (569 μm) long each wire.

Wire: 0.0007" (17.8 μm) dia., gold.

##### 2. Gain Calculations:

$$\text{MAG} = \frac{|S_{21}|}{|S_{12}|} \left( K \pm \sqrt{K^2 - 1} \right). \text{ When } K \leq 1, \text{ MAG is undefined and MSG values are used. } \text{MSG} = \frac{|S_{21}|}{|S_{12}|}, K = \frac{1 + |\Delta|^2 - |S_{11}|^2 - |S_{22}|^2}{2 |S_{12} S_{21}|}, \Delta = S_{11} S_{22} - S_{21} S_{12}$$

MAG = Maximum Available Gain

MSG = Maximum Stable Gain

**TYPICAL COMMON EMITTER SCATTERING PARAMETERS** (TA = 25°C)

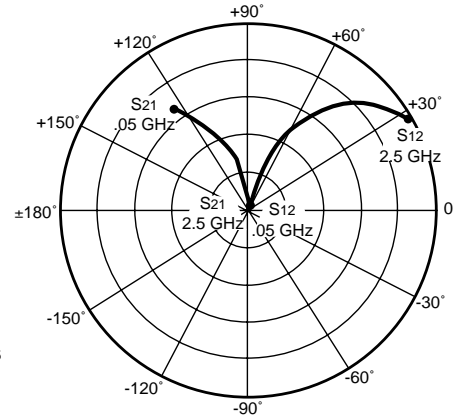
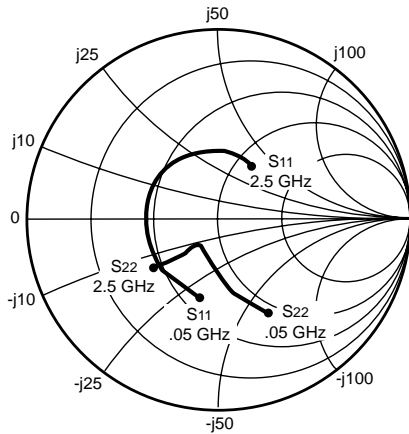

Coordinates in Ohms  
Frequency in GHz  
VCE = 5 V, IC = 50 mA

**NE46134**

VCE = 5 V, IC = 50 mA

FREQUENCY (GHz)	S11		S21		S12		S22		K	MAG <sup>2</sup> (dB)
	MAG	ANG	MAG	ANG	MAG	ANG	MAG	ANG		
0.05	0.425	-99.7	32.606	124.1	0.026	62.0	0.578	-62.5	0.50	30.9
0.10	0.412	-136.7	18.679	105.2	0.037	62.5	0.358	-86.9	0.74	27.1
0.20	0.393	-166.1	9.787	91.7	0.060	64.4	0.230	-109.0	0.95	22.2
0.40	0.385	171.3	4.993	78.6	0.107	67.5	0.186	-126.9	1.05	15.3
0.60	0.387	156.0	3.382	69.5	0.154	65.9	0.188	-133.0	1.07	11.7
0.80	0.392	143.7	2.587	61.2	0.201	62.7	0.202	-135.1	1.08	9.4
1.00	0.392	133.1	2.123	53.7	0.245	58.8	0.221	-136.0	1.07	7.8
1.20	0.397	122.5	1.822	46.5	0.288	54.5	0.244	-136.4	1.06	6.5
1.40	0.391	113.1	1.620	39.8	0.327	50.1	0.271	-136.9	1.05	5.6
1.60	0.382	103.9	1.449	33.6	0.363	45.6	0.300	-137.3	1.05	4.7
1.80	0.375	95.6	1.325	28.4	0.394	41.8	0.328	-139.0	1.04	4.0
2.00	0.372	85.9	1.239	23.2	0.428	37.6	0.352	-139.7	1.03	3.5
2.20	0.359	76.6	1.161	17.8	0.456	33.3	0.378	-140.3	1.03	3.0
2.40	0.348	67.0	1.100	13.3	0.482	29.2	0.400	-141.1	1.02	2.6
2.50	0.340	61.9	1.075	11.2	0.494	27.3	0.411	-141.4	1.02	2.4

VCE = 5 V, IC = 100 mA

0.05	0.388	-112.1	34.051	120.8	0.022	64.0	0.523	-69.6	0.59	31.9
0.10	0.394	-146.4	18.931	103.0	0.035	65.0	0.324	-95.6	0.82	27.3
0.20	0.381	171.4	9.827	90.6	0.060	68.3	0.221	-119.6	0.98	22.1
0.40	0.384	168.4	5.002	78.2	0.111	69.5	0.189	-137.1	1.05	15.2
0.60	0.384	153.8	3.389	69.4	0.161	67.0	0.192	-142.3	1.07	11.6
0.80	0.389	141.8	2.595	61.3	0.209	63.1	0.203	-143.6	1.07	9.3
1.00	0.388	131.1	2.135	54.0	0.256	58.8	0.219	-143.5	1.06	7.7
1.20	0.389	120.2	1.833	46.9	0.300	54.2	0.239	-142.9	1.05	6.4
1.40	0.383	110.8	1.634	40.3	0.341	49.5	0.263	-142.4	1.04	5.5
1.60	0.373	101.1	1.464	33.9	0.377	44.8	0.290	-141.9	1.04	4.6
1.80	0.364	92.8	1.340	28.7	0.409	40.8	0.316	-142.9	1.04	3.9
2.00	0.359	82.9	1.257	23.5	0.443	36.4	0.338	-143.0	1.03	3.4
2.20	0.346	73.2	1.180	18.1	0.471	32.0	0.362	-143.1	1.03	3.0
2.40	0.334	63.2	1.121	13.4	0.497	27.7	0.384	-143.3	1.03	2.6
2.50	0.327	57.8	1.092	11.4	0.508	25.7	0.394	-143.4	1.03	2.3

VCE = 8 V, IC = 50 mA

0.05	0.439	-95.9	33.732	125.2	0.024	61.2	0.594	-58.7	0.48	31.4
0.10	0.397	-133.0	19.510	106.0	0.036	62.2	0.363	-81.0	0.74	27.4
0.20	0.368	-162.9	10.263	92.2	0.058	65.1	0.227	-100.6	0.95	22.5
0.40	0.364	172.4	5.239	79.1	0.103	68.1	0.176	-117.2	1.05	15.7
0.60	0.363	156.6	3.545	70.0	0.150	66.3	0.178	-123.5	1.07	12.1
0.80	0.369	143.8	2.706	61.7	0.195	63.1	0.193	-126.3	1.07	9.8
1.00	0.368	132.9	2.216	54.3	0.238	59.3	0.215	-128.0	1.07	8.1
1.20	0.375	121.7	1.896	46.9	0.279	55.1	0.241	-129.2	1.06	6.8
1.40	0.371	112.8	1.681	40.3	0.319	50.8	0.270	-130.5	1.05	5.9
1.60	0.365	103.2	1.499	34.0	0.353	46.3	0.302	-131.7	1.04	5.0
1.80	0.360	94.9	1.368	28.9	0.384	42.6	0.331	-133.9	1.04	4.3
2.00	0.357	85.1	1.274	23.7	0.417	38.4	0.358	-135.1	1.03	3.8
2.20	0.345	75.4	1.191	18.1	0.445	34.2	0.385	-136.2	1.03	3.3
2.40	0.335	65.8	1.126	13.6	0.470	30.2	0.409	-137.3	1.02	2.9
2.50	0.331	60.7	1.094	11.7	0.482	28.3	0.421	-137.8	1.02	2.7

See notes on previous page.

# NE46100, NE46134

## TYPICAL COMMON EMITTER SCATTERING PARAMETERS (T<sub>A</sub> = 25°C)

### NE46134

VCE = 8 V, Ic = 100 mA

FREQUENCY (GHz)	S <sub>11</sub>		S <sub>21</sub>		S <sub>12</sub>		S <sub>22</sub>		K	MAG <sup>2</sup> (dB)
	MAG	ANG	MAG	ANG	MAG	ANG	MAG	ANG		
0.05	0.366	-103.2	35.884	122.0	0.022	60.3	0.533	-65.3	0.59	32.2
0.10	0.374	-141.4	20.121	103.8	0.033	64.0	0.329	-89.2	0.81	27.8
0.20	0.361	-168.7	10.486	91.2	0.058	68.5	0.214	-110.9	0.97	22.6
0.40	0.358	169.1	5.335	78.8	0.106	69.7	0.175	-128.0	1.05	15.7
0.60	0.363	154.2	3.610	70.1	0.154	67.3	0.179	-133.6	1.06	12.2
0.80	0.368	141.6	2.755	62.0	0.200	63.6	0.193	-135.3	1.07	9.8
1.00	0.369	130.7	2.257	54.7	0.245	59.4	0.211	-135.8	1.06	8.1
1.20	0.372	120.0	1.933	47.8	0.287	55.0	0.235	-135.9	1.05	6.9
1.40	0.366	110.4	1.713	41.1	0.327	50.4	0.262	-136.1	1.04	5.9
1.60	0.359	100.9	1.532	34.8	0.362	45.8	0.291	-136.3	1.04	5.0
1.80	0.353	92.4	1.397	29.7	0.393	41.9	0.319	-137.9	1.04	4.3
2.00	0.350	82.8	1.305	24.4	0.426	37.6	0.344	-138.5	1.03	3.8
2.20	0.339	73.3	1.220	19.0	0.453	33.3	0.370	-139.0	1.03	3.3
2.40	0.329	63.5	1.153	14.4	0.478	29.2	0.393	-139.7	1.02	2.9
2.50	0.324	58.2	1.120	12.3	0.490	27.2	0.403	-140.0	1.03	2.6

VCE = 10 V, Ic = 50 mA

0.50	0.416	-90.3	34.060	125.4	0.025	60.6	0.589	-58.0	0.52	31.4
0.10	0.393	-132.0	19.738	106.2	0.035	60.6	0.365	-79.9	0.74	27.5
0.20	0.361	-162.4	10.390	92.3	0.057	65.0	0.226	-99.1	0.95	22.6
0.40	0.356	172.5	5.308	79.2	0.103	68.1	0.174	-115.3	1.05	15.8
0.60	0.356	156.9	3.589	70.1	0.149	66.3	0.176	-121.7	1.07	12.2
0.80	0.362	143.8	2.738	61.8	0.194	63.1	0.192	-124.7	1.07	9.9
1.00	0.365	132.9	2.241	54.4	0.237	59.3	0.213	-126.4	1.07	8.2
1.20	0.369	121.8	1.915	47.2	0.278	55.2	0.240	-127.8	1.06	6.9
1.40	0.363	112.5	1.698	40.5	0.317	50.9	0.269	-129.3	1.05	6.0
1.60	0.356	102.9	1.514	34.2	0.351	46.4	0.302	-130.5	1.05	5.0
1.80	0.354	94.7	1.380	29.0	0.382	42.7	0.332	-132.9	1.04	4.3
2.00	0.352	85.1	1.284	23.7	0.415	38.5	0.358	-134.2	1.03	3.9
2.20	0.341	75.1	1.200	18.3	0.442	34.4	0.386	-135.3	1.03	3.4
2.40	0.331	65.6	1.133	13.8	0.468	30.3	0.411	-136.5	1.02	3.0
2.50	0.324	60.5	1.101	11.8	0.479	28.4	0.422	-137.0	1.02	2.7

VCE = 10 V, Ic = 100 mA

0.05	0.377	-101.0	36.164	122.1	0.022	66.4	0.536	-63.9	0.58	32.2
0.10	0.358	-139.9	20.301	103.9	0.034	66.5	0.327	-87.1	0.82	27.8
0.20	0.345	-167.5	10.586	91.2	0.058	68.1	0.209	-108.1	0.97	22.6
0.40	0.342	169.7	5.386	78.8	0.107	69.8	0.169	-125.0	1.05	15.7
0.60	0.349	154.1	3.646	70.1	0.155	67.3	0.173	-130.6	1.06	12.2
0.80	0.350	141.2	2.782	62.0	0.202	63.5	0.187	-132.5	1.06	9.8
1.00	0.351	130.1	2.278	54.8	0.247	59.3	0.206	-133.1	1.06	8.1
1.20	0.356	119.1	1.952	47.6	0.289	54.8	0.230	-133.3	1.05	6.9
1.40	0.350	109.5	1.729	41.0	0.329	50.2	0.258	-133.7	1.04	5.9
1.60	0.342	100.0	1.543	34.8	0.364	45.7	0.289	-134.1	1.04	5.0
1.80	0.337	91.1	1.409	29.6	0.395	41.6	0.318	-136.0	1.04	4.3
2.00	0.333	80.8	1.316	24.4	0.428	37.3	0.343	-136.6	1.03	3.8
2.20	0.323	70.8	1.229	18.8	0.455	33.0	0.370	-137.3	1.03	3.3
2.40	0.312	60.8	1.163	14.4	0.481	28.9	0.394	-138.1	1.02	2.9
2.50	0.308	55.2	1.132	12.2	0.492	26.9	0.406	-138.5	1.02	2.7

#### Notes:

1. The NE46134 was measured with the package mounted on a 0.030" thick RT Duroid 5880 substrate.

To avoid exceeding T<sub>J</sub> MAX when using poor thermal conducting substrates, use of a heat sink is recommended. For example:

The Thermalloy 7100D series heat sink or thermal equivalent may be suitable. The above S parameters were measured without heat sink.

2. Gain Calculations:

$$MAG = \frac{|S_{21}|}{|S_{12}|} \left( K \pm \sqrt{K^2 - 1} \right). \text{ When } K \leq 1, \text{ MAG is undefined and MSG values are used. } MSG = \frac{|S_{21}|}{|S_{12}|}, K = \frac{1 + |\Delta|^2 - |S_{11}|^2 - |S_{22}|^2}{2 |S_{12} S_{21}|}, \Delta = S_{11} S_{22} - S_{21} S_{12}$$

MAG = Maximum Available Gain

MSG = Maximum Stable Gain



**TYPICAL COMMON EMITTER SCATTERING PARAMETERS** (T<sub>A</sub> = 25°C)

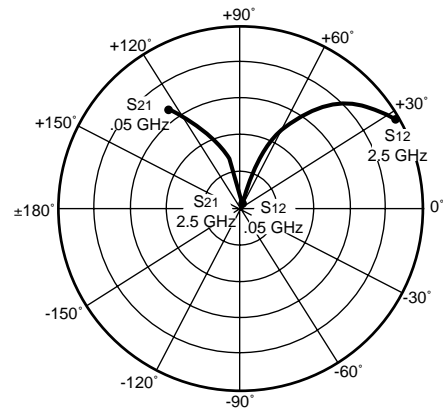
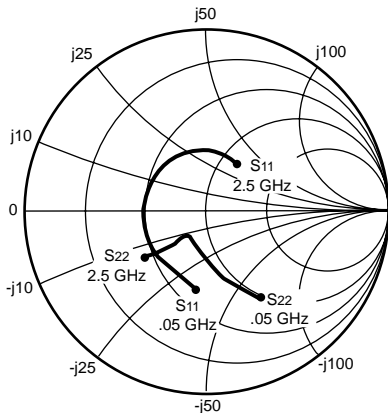

Coordinates in Ohms  
Frequency in GHz  
V<sub>CE</sub> = 12.5 V, I<sub>C</sub> = 50 mA

**NE46134**

V<sub>CE</sub> = 12.5 V, I<sub>C</sub> = 50 mA

FREQUENCY (GHz)	S <sub>11</sub>		S <sub>21</sub>		S <sub>12</sub>		S <sub>22</sub>		K	MAG <sup>2</sup> (dB)
	MAG	ANG	MAG	ANG	MAG	ANG	MAG	ANG		
0.05	0.432	-91.9	34.139	125.6	0.024	63.0	0.586	-56.7	0.50	31.5
0.10	0.372	-129.4	19.834	106.3	0.036	63.5	0.362	-78.4	0.75	27.4
0.20	0.348	-161.2	10.443	92.4	0.058	65.4	0.223	-97.1	0.95	22.6
0.40	0.343	173.5	5.332	79.3	0.104	68.1	0.170	-112.8	1.05	15.8
0.60	0.343	157.1	3.610	70.1	0.150	66.3	0.172	-119.3	1.07	12.2
0.80	0.349	143.8	2.755	61.8	0.196	63.1	0.188	-122.4	1.07	9.9
1.00	0.352	132.4	2.254	54.4	0.239	59.2	0.210	-124.2	1.07	8.2
1.20	0.353	121.2	1.927	47.1	0.280	55.0	0.236	-125.8	1.06	6.9
1.40	0.350	111.6	1.710	40.4	0.320	50.7	0.267	-127.4	1.05	6.0
1.60	0.343	101.9	1.523	34.0	0.354	46.2	0.300	-128.9	1.04	5.0
1.80	0.339	93.1	1.388	29.0	0.385	42.4	0.330	-131.5	1.04	4.3
2.00	0.336	83.3	1.295	23.5	0.418	38.2	0.357	-132.7	1.03	3.9
2.20	0.325	73.3	1.206	18.1	0.445	34.0	0.386	-134.0	1.03	3.3
2.40	0.318	63.0	1.140	13.6	0.471	29.9	0.411	-135.3	1.02	3.0
2.50	0.314	57.3	1.109	11.7	0.482	28.0	0.423	-135.9	1.02	2.7

V<sub>CE</sub> = 12.5 V, I<sub>C</sub> = 100 mA

0.05	0.380	-100.0	36.475	122.4	0.021	64.3	0.530	-62.6	0.59	32.4
0.10	0.355	-137.9	20.531	104.1	0.033	65.0	0.324	-86.1	0.82	27.9
0.20	0.341	-167.1	10.702	91.3	0.058	68.3	0.208	-106.6	0.97	22.7
0.40	0.338	170.0	5.446	79.0	0.106	69.6	0.167	-123.6	1.05	15.8
0.60	0.339	154.4	3.684	70.2	0.154	67.2	0.170	-129.1	1.06	12.3
0.80	0.344	141.3	2.812	62.1	0.201	63.5	0.185	-131.1	1.06	9.9
1.00	0.346	130.1	2.302	54.9	0.246	59.3	0.204	-131.7	1.06	8.2
1.20	0.349	119.2	1.971	47.8	0.288	54.9	0.229	-132.1	1.05	7.0
1.40	0.345	109.4	1.748	41.2	0.327	50.3	0.257	-132.7	1.04	6.0
1.60	0.336	99.7	1.557	34.9	0.362	45.7	0.288	-133.1	1.04	5.1
1.80	0.330	91.1	1.420	29.7	0.393	41.7	0.317	-135.0	1.04	4.3
2.00	0.328	80.3	1.324	24.6	0.426	37.4	0.343	-135.8	1.03	3.8
2.20	0.320	70.4	1.240	19.0	0.453	33.1	0.370	-136.5	1.03	3.4
2.40	0.309	60.2	1.170	14.4	0.478	29.0	0.395	-137.3	1.02	2.9
2.50	0.305	54.5	1.140	12.2	0.489	27.0	0.406	-137.8	1.02	2.7

See notes on previous page

**OUTLINE DIMENSIONS**

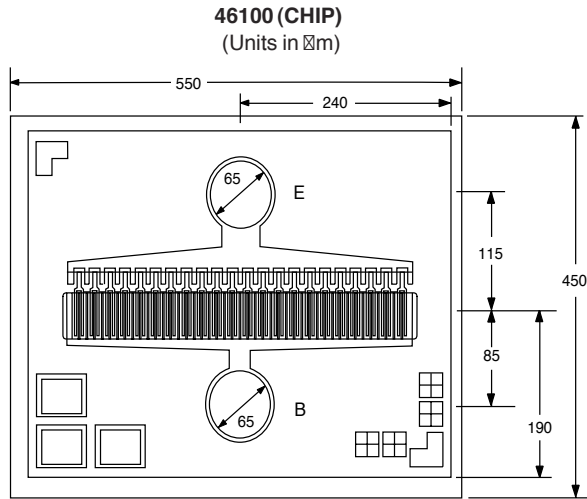

Thickness: 160  $\mu\text{m}$

**PACKAGE OUTLINE 34**  
(SOT-89)  
(Units in mm)

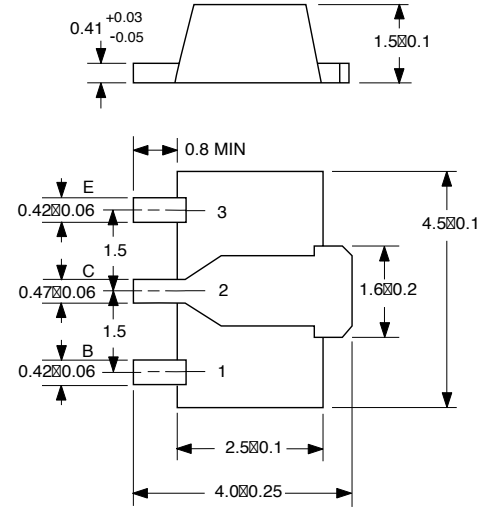

**BOTTOM VIEW**

**TOP VIEW**

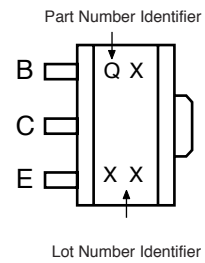

**ORDERING INFORMATION**

PART NUMBER	QUANTITY	PACKAGING
NE46100	100	Waffle Pack
NE46134-T1	1000	Tape & Reel