

## NPN SILICON HIGH FREQUENCY TRANSISTOR

### FEATURES

- **SMALL PACKAGE STYLE:**  
2 NE685 Die in a 2 mm x 1.25 mm package
- **LOW NOISE FIGURE:**  
NF = 1.5 dB TYP at 2 GHz
- **HIGH GAIN:**  
 $IS_{21E}I^2 = 8.5$  dB TYP at 2 GHz
- **HIGH GAIN BANDWIDTH:**  $f_r = 12$  GHz
- **EXCELLENT LOW VOLTAGE, LOW CURRENT PERFORMANCE**

### DESCRIPTION

The UPA806T is two NPN high frequency silicon epitaxial transistors encapsulated in an ultra small 6 pin SMT package. Each transistor is independently mounted and easily configured for either dual transistor or cascode operation. The high  $f_r$ , low voltage bias and small size make this device suited for various hand-held wireless applications.

### OUTLINE DIMENSIONS (Units in mm)

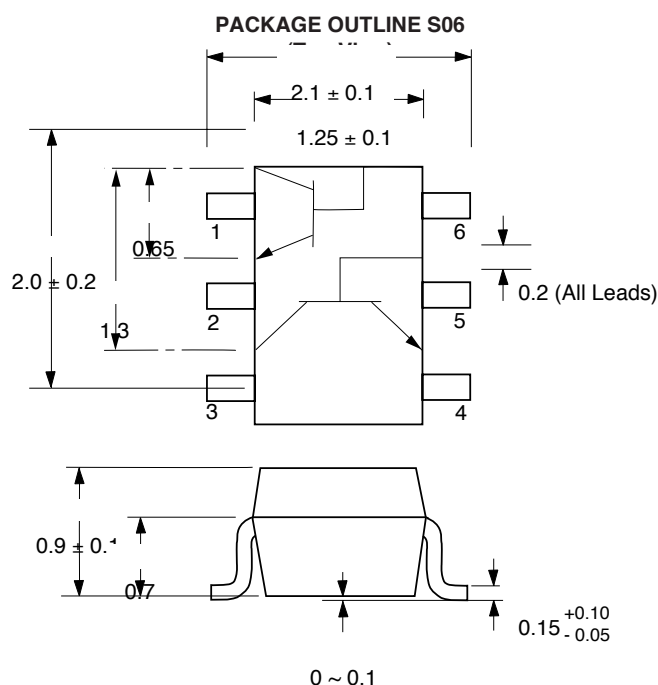

#### PIN OUT

1. Collector Transistor 1
2. Emitter Transistor 1
3. Collector Transistor 2
4. Emitter Transistor 2
5. Base Transistor 2
6. Base Transistor 1

#### Note:

Pin 3 is identified with a circle on the bottom of the package.

### ELECTRICAL CHARACTERISTICS ( $T_A = 25^\circ\text{C}$ )

PART NUMBER PACKAGE OUTLINE			UPA806T S06		
SYMBOLS	PARAMETERS AND CONDITIONS	UNITS	MIN	TYP	MAX
$I_{CBO}$	Collector Cutoff Current at $V_{CB} = 5$ V, $I_E = 0$	$\mu\text{A}$			0.1
$I_{EBO}$	Emitter Cutoff Current at $V_{EB} = 1$ V, $I_C = 0$	$\mu\text{A}$			0.1
$h_{FE}^1$	Forward Current Gain at $V_{CE} = 3$ V, $I_C = 10$ mA		75	100	150
$f_r$	Gain Bandwidth at $V_{CE} = 3$ V, $I_C = 10$ mA, $f = 2$ GHz	GHz		12	
$C_{re}^2$	Feedback Capacitance at $V_{CB} = 3$ V, $I_E = 0$ , $f = 1$ MHz	pF		0.4	0.7
$IS_{21E}I^2$	Insertion Power Gain at $V_{CE} = 3$ V, $I_C = 10$ mA, $f = 2$ GHz	dB	7	8.5	
NF	Noise Figure at $V_{CE} = 3$ V, $I_C = 3$ mA, $f = 2$ GHz	dB		1.5	2.5
$h_{FE1}/h_{FE2}$	$h_{FE}$ Ratio: $h_{FE1} =$ Smaller Value of Q1, or Q2 $h_{FE2} =$ Larger Value of Q1 or Q2		0.85		

Notes: 1. Pulsed measurement, pulse width  $\leq 350$   $\mu\text{s}$ , duty cycle  $\leq 2\%$ .

2. The emitter terminal should be connected to the ground terminal of the 3 terminal capacitance bridge.

For Tape and Reel version use part number UPA806T-T1, 3K per reel.

**ABSOLUTE MAXIMUM RATINGS<sup>1</sup>** (T<sub>A</sub> = 25°C)

SYMBOLS	PARAMETERS	UNITS	RATINGS
V <sub>CBO</sub>	Collector to Base Voltage	V	9
V <sub>CEO</sub>	Collector to Emitter Voltage	V	6
V <sub>EBO</sub>	Emitter to Base Voltage	V	2
I <sub>C</sub>	Collector Current	mA	30
PT	Total Power Dissipation		
	1 Die	mW	110
	2 Die	mW	200
T <sub>J</sub>	Junction Temperature	°C	150
T <sub>STG</sub>	Storage Temperature	°C	-65 to +150

Note: 1. Operation in excess of any one of these parameters may result in permanent damage.

**ORDERING INFORMATION**

PART NUMBER	QUANTITY	PACKAGING
UPA806T-T1-A	3000	Tape & Reel

**TYPICAL PERFORMANCE CURVES**

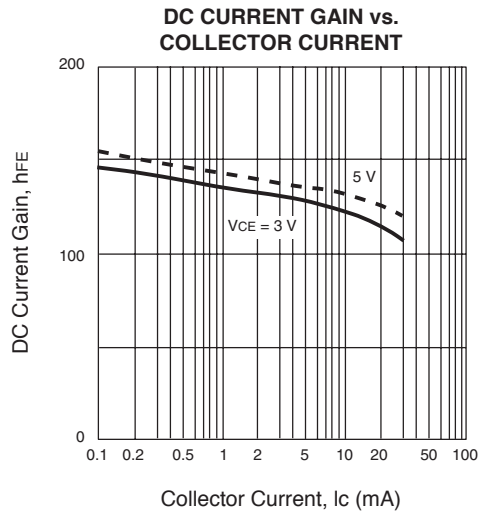
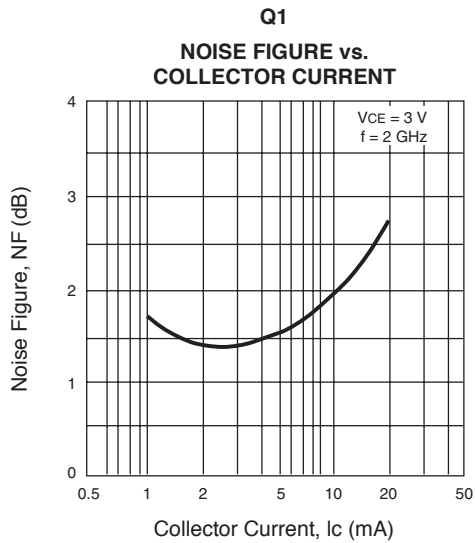
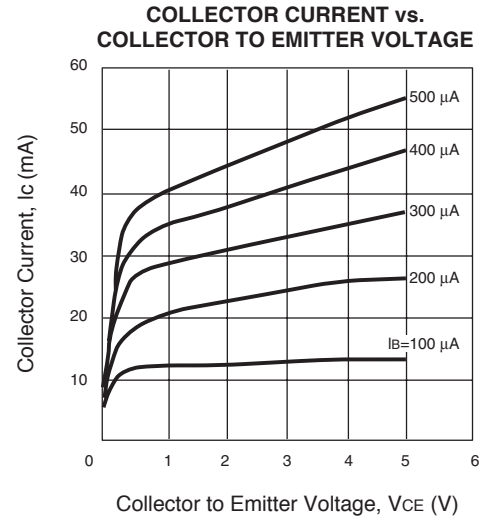
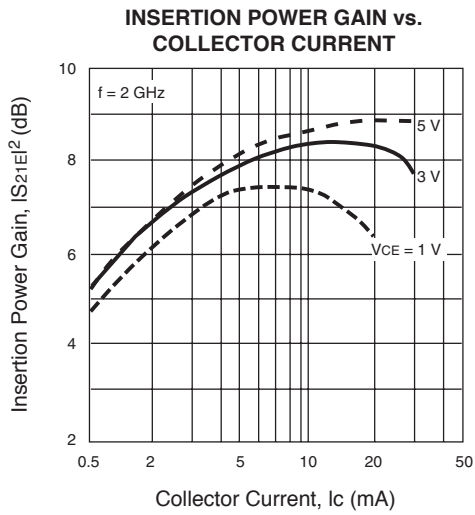

## TYPICAL PERFORMANCE CURVES

**GAIN BANDWIDTH PRODUCT vs. COLLECTOR CURRENT**

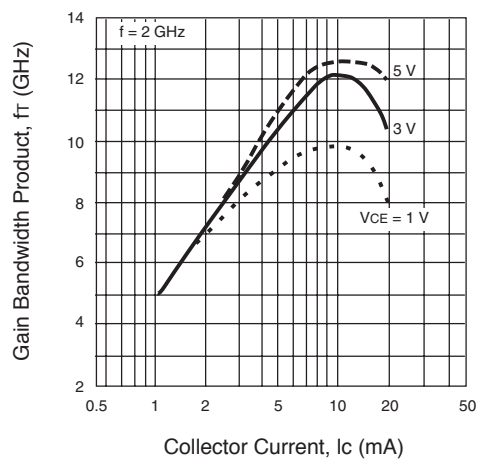

**FEEDBACK CAPACITANCE vs. COLLECTOR TO BASE VOLTAGE**

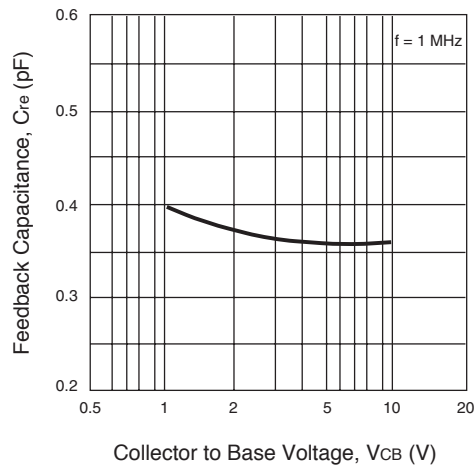

**TOTAL POWER DISSIPATION vs. AMBIENT TEMPERATURE**

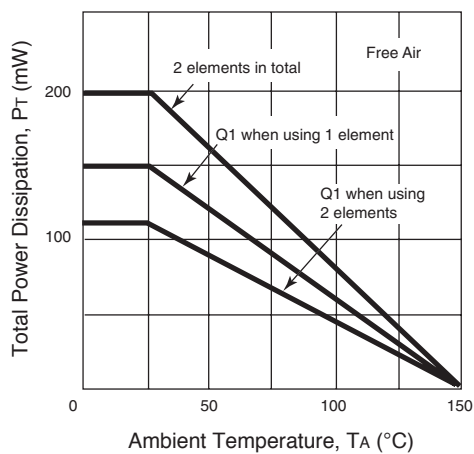

**COLLECTOR CURRENT vs. BASE TO EMITTER VOLTAGE**

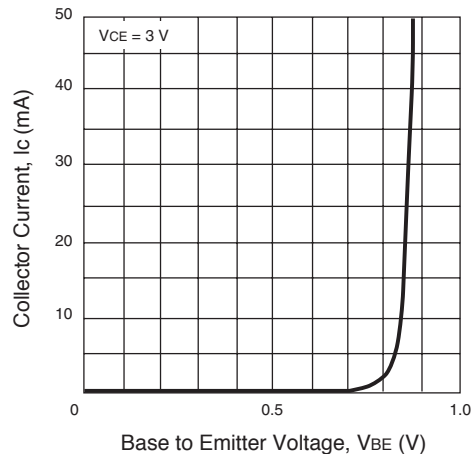

# UPA806T

## TYPICAL SCATTERING PARAMETERS (TA = 25°C)

### UPA806T(Q1)

VCE = 1 V, IC = 1 mA

FREQUENCY (GHz)	S11		S21		S12		S22		K	Gmag (dB)
	MAG	ANG	MAG	ANG	MAG	ANG	MAG	ANG		
0.50	0.893	-33.80	2.828	145.80	0.098	67.30	0.933	-20.90	0.218	14.603
0.60	0.846	-40.80	2.750	139.10	0.116	62.10	0.911	-24.50	0.282	13.749
0.80	0.766	-53.80	2.615	127.20	0.145	54.30	0.867	-31.20	0.365	12.561
1.00	0.693	-65.70	2.486	116.60	0.169	47.80	0.823	-37.40	0.435	11.676
1.20	0.624	-76.80	2.354	106.90	0.187	42.10	0.778	-43.20	0.502	11.000
1.40	0.558	-87.70	2.221	97.90	0.201	37.10	0.735	-48.70	0.568	10.434
1.60	0.498	-98.60	2.093	89.40	0.212	32.70	0.694	-53.90	0.633	9.944
1.80	0.445	-109.60	1.973	81.30	0.220	28.90	0.656	-58.90	0.699	9.527
2.00	0.400	-120.50	1.865	73.90	0.226	25.70	0.621	-63.60	0.764	9.166
2.20	0.362	-131.30	1.766	67.00	0.229	23.20	0.591	-68.00	0.830	8.872
2.40	0.329	-142.00	1.677	60.90	0.232	21.30	0.565	-72.00	0.893	8.590
2.60	0.301	-152.90	1.593	55.30	0.233	20.00	0.542	-75.80	0.960	8.349
2.80	0.279	-165.00	1.515	50.10	0.234	18.90	0.523	-79.30	1.022	7.202
3.00	0.268	-179.10	1.445	44.80	0.235	18.10	0.506	-82.70	1.076	6.207

### UPA806T(Q2)

VCE = 1 V, IC = 1 mA

FREQUENCY (GHz)	S11		S21		S12		S22		K	Gmag (dB)
	MAG	ANG	MAG	ANG	MAG	ANG	MAG	ANG		
0.50	0.899	-34.10	2.832	145.80	0.090	66.90	0.937	-20.70	0.210	14.979
0.60	0.856	-41.10	2.755	139.20	0.106	61.70	0.916	-24.20	0.272	14.148
0.80	0.783	-54.00	2.622	127.40	0.134	53.60	0.873	-30.80	0.357	12.915
1.00	0.717	-65.70	2.495	116.80	0.155	47.10	0.831	-36.90	0.424	12.067
1.20	0.655	-76.60	2.367	107.10	0.172	41.30	0.789	-42.60	0.490	11.387
1.40	0.595	-87.00	2.239	98.00	0.185	36.10	0.747	-48.00	0.559	10.829
1.60	0.540	-97.20	2.116	89.50	0.196	31.60	0.707	-53.10	0.625	10.333
1.80	0.490	-107.20	2.001	81.40	0.204	27.60	0.670	-58.10	0.692	9.916
2.00	0.447	-116.90	1.898	73.80	0.210	24.20	0.635	-62.80	0.760	9.561
2.20	0.408	-126.30	1.804	66.80	0.215	21.50	0.604	-67.40	0.825	9.238
2.40	0.372	-135.40	1.719	60.40	0.218	19.20	0.577	-71.70	0.893	8.968
2.60	0.339	-144.60	1.640	54.50	0.220	17.50	0.552	-75.90	0.962	8.724
2.80	0.311	-154.90	1.565	48.90	0.221	16.00	0.531	-80.00	1.028	7.467
3.00	0.290	-167.50	1.497	43.20	0.223	14.60	0.511	-84.00	1.087	6.474

Note:

1. Gain Calculation:

$$\text{MAG} = \frac{|S_{21}|}{|S_{12}|} \left( K \pm \sqrt{K^2 - 1} \right). \text{ When } K \leq 1, \text{ MAG is undefined and MSG values are used. } \text{MSG} = \frac{|S_{21}|}{|S_{12}|}, K = \frac{1 + |\Delta|^2 - |S_{11}|^2 - |S_{22}|^2}{2 |S_{12}| |S_{21}|}, \Delta = S_{11} S_{22} - S_{21} S_{12}$$

MAG = Maximum Available Gain

MSG = Maximum Stable Gain

## TYPICAL SCATTERING PARAMETERS (T<sub>A</sub> = 25°C)

### UPA806T(Q1)

V<sub>CE</sub> = 2 V, I<sub>C</sub> = 5 mA

FREQUENCY (GHz)	S <sub>11</sub>		S <sub>21</sub>		S <sub>12</sub>		S <sub>22</sub>		K	G <sub>mag</sub> (dB)
	MAG	ANG	MAG	ANG	MAG	ANG	MAG	ANG		
0.50	0.537	-62.90	8.804	121.00	0.064	60.90	0.710	-34.60	0.533	21.385
0.60	0.464	-68.80	7.894	115.70	0.071	59.00	0.664	-36.80	0.617	20.460
0.80	0.351	-81.80	6.511	105.20	0.085	56.60	0.587	-40.90	0.744	18.842
1.00	0.272	-95.90	5.539	95.50	0.097	55.20	0.529	-44.70	0.837	17.567
1.20	0.216	-110.40	4.820	87.10	0.110	54.10	0.485	-48.20	0.901	16.417
1.40	0.176	-125.30	4.250	80.20	0.123	53.20	0.451	-51.40	0.949	15.385
1.60	0.146	-140.60	3.778	74.60	0.135	52.40	0.425	-54.30	0.992	14.469
1.80	0.124	-156.90	3.381	69.80	0.148	51.40	0.404	-57.20	1.028	12.563
2.00	0.112	-174.00	3.055	65.40	0.161	50.40	0.387	-60.00	1.057	11.326
2.20	0.109	169.30	2.800	61.00	0.174	49.20	0.372	-63.00	1.077	10.374
2.40	0.113	154.50	2.612	56.40	0.187	47.90	0.360	-66.20	1.085	9.676
2.60	0.124	142.00	2.477	51.70	0.201	46.50	0.349	-69.70	1.078	9.199
2.80	0.140	131.40	2.371	47.00	0.214	44.90	0.339	-73.40	1.069	8.836
3.00	0.162	121.50	2.249	42.80	0.226	43.20	0.329	-77.10	1.069	8.380

### UPA806T(Q2)

V<sub>CE</sub> = 2 V, I<sub>C</sub> = 5 mA

FREQUENCY (GHz)	S <sub>11</sub>		S <sub>21</sub>		S <sub>12</sub>		S <sub>22</sub>		K	G <sub>mag</sub> (dB)
	MAG	ANG	MAG	ANG	MAG	ANG	MAG	ANG		
0.50	0.562	-61.50	8.997	121.90	0.059	60.70	0.729	-33.10	0.516	21.832
0.60	0.491	-67.40	8.086	116.40	0.066	58.50	0.683	-35.20	0.602	20.882
0.80	0.383	-80.00	6.704	105.60	0.078	55.70	0.608	-39.20	0.733	19.342
1.00	0.307	-92.90	5.732	95.60	0.089	54.00	0.550	-42.80	0.830	18.089
1.20	0.253	-105.30	5.008	87.10	0.101	52.70	0.506	-46.00	0.895	16.953
1.40	0.212	-117.00	4.429	79.90	0.112	51.70	0.472	-48.90	0.950	15.971
1.60	0.179	-128.10	3.945	74.00	0.124	50.70	0.445	-51.40	0.993	15.026
1.80	0.153	-139.00	3.536	68.90	0.136	49.60	0.423	-53.90	1.031	13.065
2.00	0.132	-150.50	3.200	64.20	0.148	48.40	0.404	-56.50	1.064	11.801
2.20	0.118	-162.90	2.937	59.50	0.160	47.10	0.388	-59.30	1.087	10.839
2.40	0.111	-176.20	2.744	54.60	0.173	45.70	0.374	-62.40	1.093	10.141
2.60	0.110	169.90	2.608	49.60	0.185	44.00	0.361	-65.80	1.093	9.637
2.80	0.115	155.50	2.501	44.80	0.198	42.30	0.348	-69.50	1.083	9.254
3.00	0.127	140.60	2.376	40.20	0.210	40.30	0.336	-73.40	1.083	8.783

Note:

1. Gain Calculation:

$$\text{MAG} = \frac{|S_{21}|}{|S_{12}|} (K \pm \sqrt{K^2 - 1}). \text{ When } K \leq 1, \text{ MAG is undefined and MSG values are used. } \text{MSG} = \frac{|S_{21}|}{|S_{12}|}, K = \frac{1 + |\Delta|^2 - |S_{11}|^2 - |S_{22}|^2}{2 |S_{12}| |S_{21}|}, \Delta = S_{11} S_{22} - S_{21} S_{12}$$

MAG = Maximum Available Gain

MSG = Maximum Stable Gain

# UPA806T

## TYPICAL SCATTERING PARAMETERS (T<sub>A</sub> = 25°C)

### UPA806T(Q1)

V<sub>CE</sub> = 2 V, I<sub>C</sub> = 10 mA

FREQUENCY (GHz)	S <sub>11</sub>		S <sub>21</sub>		S <sub>12</sub>		S <sub>22</sub>		K	Gmag (dB)
	MAG	ANG	MAG	ANG	MAG	ANG	MAG	ANG		
0.50	0.323	-79.50	10.650	109.10	0.054	63.40	0.567	-37.90	0.754	22.950
0.60	0.270	-85.10	9.383	105.00	0.061	63.30	0.532	-38.90	0.812	21.870
0.80	0.190	-99.30	7.445	96.40	0.074	62.90	0.473	-41.00	0.910	20.026
1.00	0.137	-118.00	6.111	88.00	0.089	62.30	0.430	-43.40	0.968	18.367
1.20	0.107	-140.80	5.181	80.50	0.103	61.40	0.398	-46.10	1.010	16.405
1.40	0.095	-164.50	4.507	74.50	0.118	60.30	0.374	-48.90	1.032	14.716
1.60	0.093	174.40	3.991	69.90	0.133	59.00	0.357	-51.80	1.047	13.443
1.80	0.096	157.30	3.581	66.10	0.148	57.50	0.343	-54.80	1.059	12.352
2.00	0.103	143.70	3.247	62.70	0.162	55.90	0.332	-57.90	1.071	11.392
2.20	0.113	132.80	2.977	58.90	0.177	54.20	0.322	-61.10	1.076	10.577
2.40	0.125	124.10	2.763	54.50	0.192	52.30	0.312	-64.50	1.076	9.896
2.60	0.141	116.90	2.597	49.50	0.206	50.40	0.302	-68.20	1.073	9.353
2.80	0.159	110.80	2.465	44.30	0.221	48.40	0.293	-72.20	1.063	8.942
3.00	0.181	105.10	2.330	40.10	0.234	46.40	0.284	-76.40	1.061	8.476

### UPA806T(Q2)

V<sub>CE</sub> = 2 V, I<sub>C</sub> = 10 mA

FREQUENCY (GHz)	S <sub>11</sub>		S <sub>21</sub>		S <sub>12</sub>		S <sub>22</sub>		K	Gmag (dB)
	MAG	ANG	MAG	ANG	MAG	ANG	MAG	ANG		
0.50	0.348	-77.00	11.024	109.80	0.050	62.90	0.590	-36.20	0.739	23.434
0.60	0.297	-82.40	9.724	105.50	0.056	62.50	0.554	-37.10	0.803	22.397
0.80	0.218	-95.00	7.740	96.50	0.068	61.80	0.495	-39.10	0.905	20.562
1.00	0.165	-110.00	6.376	87.80	0.081	61.00	0.451	-41.20	0.971	18.961
1.20	0.131	-126.30	5.424	80.10	0.095	60.00	0.419	-43.40	1.009	16.991
1.40	0.111	-142.60	4.728	73.90	0.108	58.80	0.395	-45.70	1.037	15.227
1.60	0.098	-158.20	4.192	68.90	0.122	57.40	0.377	-48.10	1.054	13.945
1.80	0.090	-172.90	3.761	64.90	0.135	55.80	0.363	-50.60	1.071	12.828
2.00	0.086	173.10	3.411	61.20	0.149	54.10	0.350	-53.20	1.081	11.860
2.20	0.086	159.80	3.129	57.10	0.163	52.20	0.338	-56.10	1.088	11.023
2.40	0.091	147.40	2.909	52.40	0.177	50.20	0.326	-59.20	1.089	10.335
2.60	0.101	136.10	2.743	47.10	0.191	48.10	0.314	-62.70	1.084	9.804
2.80	0.115	126.00	2.611	41.80	0.205	45.90	0.302	-66.50	1.075	9.382
3.00	0.134	116.50	2.474	37.20	0.218	43.60	0.291	-70.70	1.071	8.922

Note:

1. Gain Calculation:

$$\text{MAG} = \frac{|S_{21}|}{|S_{12}|} \left( K \pm \sqrt{K^2 - 1} \right). \text{ When } K \leq 1, \text{ MAG is undefined and MSG values are used. } \text{MSG} = \frac{|S_{21}|}{|S_{12}|}, K = \frac{1 + |\Delta|^2 - |S_{11}|^2 - |S_{22}|^2}{2 |S_{12}| |S_{21}|}, \Delta = S_{11} S_{22} - S_{21} S_{12}$$

MAG = Maximum Available Gain

MSG = Maximum Stable Gain

## TYPICAL SCATTERING PARAMETERS (T<sub>A</sub> = 25°C)

### UPA806T(Q1)

V<sub>CE</sub> = 3 V, I<sub>C</sub> = 10 mA

FREQUENCY (GHz)	S <sub>11</sub>		S <sub>21</sub>		S <sub>12</sub>		S <sub>22</sub>		K	Gmag (dB)
	MAG	ANG	MAG	ANG	MAG	ANG	MAG	ANG		
0.50	0.337	-74.20	10.935	110.20	0.052	64.10	0.589	-35.80	0.744	23.228
0.60	0.283	-79.00	9.644	106.00	0.058	64.00	0.554	-36.70	0.807	22.208
0.80	0.198	-90.80	7.669	97.40	0.072	63.60	0.496	-38.80	0.898	20.274
1.00	0.139	-106.30	6.308	88.90	0.086	62.90	0.453	-41.10	0.959	18.654
1.20	0.101	-126.10	5.356	81.50	0.100	62.00	0.421	-43.70	0.999	17.288
1.40	0.080	-149.80	4.662	75.50	0.114	60.90	0.398	-46.30	1.024	15.163
1.60	0.071	-174.60	4.129	70.90	0.128	59.70	0.381	-49.10	1.042	13.832
1.80	0.072	163.30	3.704	67.10	0.143	58.30	0.367	-52.00	1.052	12.741
2.00	0.077	145.60	3.358	63.70	0.157	56.70	0.356	-54.90	1.063	11.767
2.20	0.087	132.20	3.078	60.00	0.172	55.10	0.346	-58.00	1.067	10.946
2.40	0.100	122.10	2.857	55.70	0.186	53.30	0.336	-61.20	1.070	10.253
2.60	0.115	114.40	2.687	50.70	0.200	51.40	0.327	-64.70	1.066	9.717
2.80	0.135	108.10	2.550	45.60	0.214	49.50	0.318	-68.40	1.057	9.301
3.00	0.157	102.50	2.411	41.50	0.227	47.50	0.309	-72.30	1.054	8.834

### UPA806T(Q2)

V<sub>CE</sub> = 3 V, I<sub>C</sub> = 10 mA

FREQUENCY (GHz)	S <sub>11</sub>		S <sub>21</sub>		S <sub>12</sub>		S <sub>22</sub>		K	Gmag (dB)
	MAG	ANG	MAG	ANG	MAG	ANG	MAG	ANG		
0.50	0.364	-71.90	11.322	111.00	0.047	63.60	0.613	-34.10	0.734	23.818
0.60	0.311	-76.60	9.999	106.60	0.053	63.20	0.578	-35.00	0.797	22.757
0.80	0.228	-87.40	7.979	97.60	0.066	62.50	0.520	-36.90	0.891	20.824
1.00	0.170	-99.80	6.588	88.80	0.078	61.70	0.477	-39.00	0.960	19.267
1.20	0.131	-113.50	5.613	81.20	0.091	60.70	0.445	-41.10	1.001	17.712
1.40	0.105	-127.60	4.897	74.90	0.104	59.50	0.422	-43.30	1.027	15.721
1.60	0.086	-141.90	4.341	70.00	0.117	58.20	0.404	-45.70	1.047	14.372
1.80	0.073	-156.70	3.895	66.00	0.130	56.60	0.390	-48.10	1.062	13.244
2.00	0.065	-172.60	3.531	62.30	0.143	55.00	0.378	-50.60	1.074	12.260
2.20	0.063	170.60	3.239	58.30	0.157	53.20	0.367	-53.40	1.079	11.433
2.40	0.065	154.00	3.012	53.60	0.171	51.20	0.355	-56.40	1.079	10.738
2.60	0.074	139.20	2.841	48.40	0.184	49.20	0.344	-59.70	1.076	10.205
2.80	0.088	126.60	2.705	43.10	0.197	47.00	0.333	-63.30	1.068	9.784
3.00	0.107	115.70	2.563	38.60	0.210	44.80	0.322	-67.30	1.064	9.320

Note:

1. Gain Calculation:

$$\text{MAG} = \frac{|S_{21}|}{|S_{12}|} \left( K \pm \sqrt{K^2 - 1} \right). \text{ When } K \leq 1, \text{ MAG is undefined and MSG values are used. } \text{MSG} = \frac{|S_{21}|}{|S_{12}|}, K = \frac{1 + |\Delta|^2 - |S_{11}|^2 - |S_{22}|^2}{2 |S_{12}| |S_{21}|}, \Delta = S_{11} S_{22} - S_{21} S_{12}$$

MAG = Maximum Available Gain

MSG = Maximum Stable Gain

## NONLINEAR MODEL

## BJT NONLINEAR MODEL PARAMETERS(1)

Parameters	Q1 & Q2	Parameters	Q1 & Q2
IS	7e-16	MJC	0.34
BF	109	XCJC	0
NF	1	CJS	0
VAF	15	VJS	0.75
IKF	0.19	MJS	0
ISE	7.9e-13	FC	0.5
NE	2.19	TF	3e-12
BR	1	XTF	5.2
NR	1.08	VTF	4.58
VAR	12.4	ITF	0.01
IKR	Infinity	PTF	0
ISC	0	TR	1e-9
NC	2	EG	1.11
RE	1.3	XTB	0
RB	10	XTI	3
RBM	8.34	KF	0
IRB	0.009	AF	1
RC	10		
CJE	0.4e-12		
VJE	0.81		
MJE	0.5		
CJC	0.18e-12		
VJC	0.75		

(1) Gummel-Poon Model

## UNITS

Parameter	Units
time	seconds
capacitance	farads
inductance	henries
resistance	ohms
voltage	volts
current	amps

## MODEL RANGE

Frequency: 0.1 to 3.0 GHz  
 Bias:  $V_{CE} = 0.5 \text{ V to } 5 \text{ V}$ ,  $I_C = 1 \text{ mA to } 10 \text{ mA}$   
 Date: 10/98

## Note:

This nonlinear model utilized the latest data available. See our Design Parameter Library at [www.cel.com](http://www.cel.com) for this data.



## NONLINEAR MODEL

## SCHEMATIC

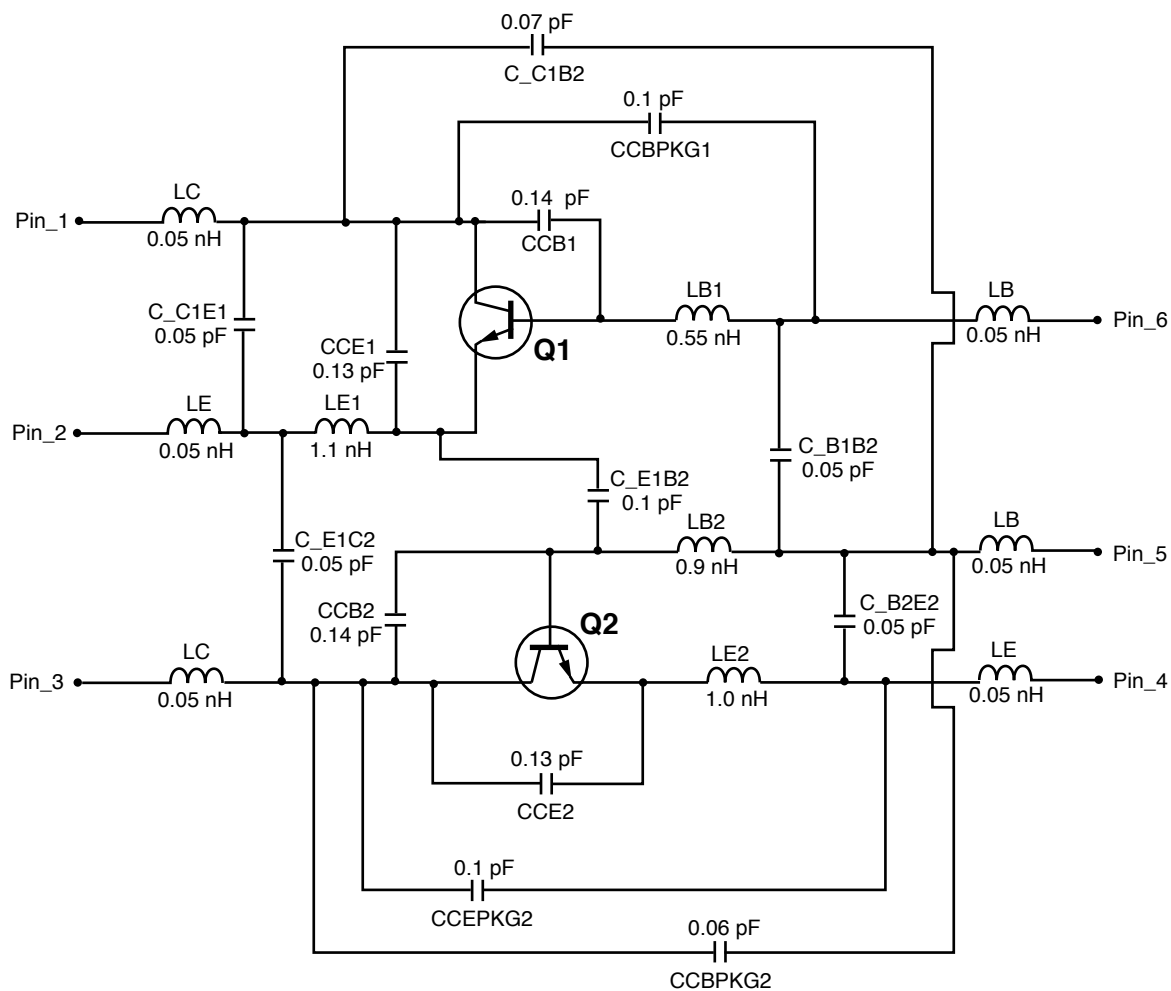

## MODEL RANGE

Frequency: 0.1 to 3.0 GHz  
 Bias:  $V_{CE} = 0.5 \text{ V to } 5 \text{ V}$ ,  $I_c = 1 \text{ mA to } 10 \text{ mA}$   
 Date: 10/98

EXCLUSIVE NORTH AMERICAN AGENT FOR RF, MICROWAVE & OPTOELECTRONIC SEMICONDUCTORS

**CEL CALIFORNIA EASTERN LABORATORIES** • Headquarters • 4590 Patrick Henry Drive • Santa Clara, CA 95054-1817 • (408) 988-3500 • Telex 34-6393 • FAX (408) 988-0279  
 24-Hour Fax-On-Demand: 800-390-3232 (U.S. and Canada only) • Internet: <http://WWW.CEL.COM>

DATA SUBJECT TO CHANGE WITHOUT NOTICE

PRINTED IN USA ON RECYCLED PAPER - 12/98