

4218 H

DC axial compact fan



ebm-papst St. Georgen GmbH & Co. KG

Hermann-Papst-Straße 1

D-78112 St. Georgen

Phone: +49(0)7724/81-0

Fax: +49(0)7724/81-1309

info2@de.ebmpapst.com

www.ebmpapst.com

Nominal data

Type	4218 H	
Nominal voltage	VDC	48
Nominal voltage range	VDC	36 .. 56
Speed	min ⁻¹	3400
Power input	W	5.6
Min. ambient temperature	°C	-20
Max. ambient temperature	°C	65
Air flow	m ³ /h	184
Sound power level	B	5.9
Sound pressure level	dB(A)	49

ml = max. load · me = max. efficiency · rfa = running at free air · cs = customer specs · cu = customer unit
Subject to alterations

Technical features

Dimensions	119 x 119 x 38 mm
General description	Optional Vario-Pro: Highly flexible software configuration for the fan ensures an easily customizable solution to meet the individual requirements of your application. Electronic commutation completely integrated.
Connection line	Single strands AWG 22, TR 64, bared and tin-plated.
Locked-rotor protection	Blocking and overload protection
Direction of rotation	Left, looking at rotor
Direction of air flow	Air exhaust over bars
Bearing	Ball bearings
Lifetime L10 at 40 °C	60000 h
Lifetime L10 at maximum temperature	32500 h
Mass	0.290 kg
Housing material	Fiberglass-reinforced PBT plastic
Material of impeller	Fiberglass-reinforced PA plastic
Motor protection	Protected against reverse polarity and locking.
Approval	VDE, CSA, UL, CE

Product drawing

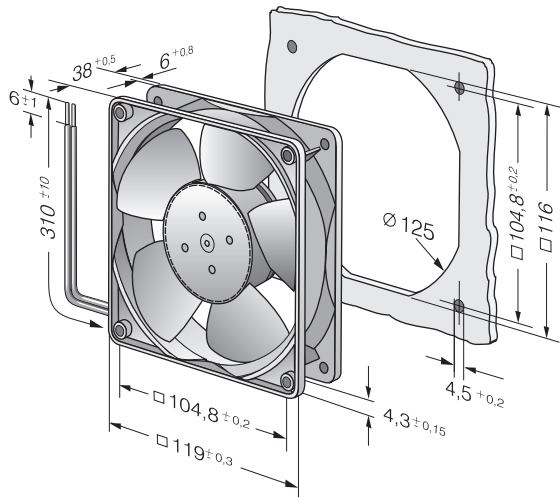

Charts: Air flow

