

4412 H

DC axial compact fan

sickled blades (S series)



ebm-papst St. Georgen GmbH & Co. KG

Hermann-Papst-Str. 1

D-78112 St. Georgen

Phone +49 (0) 7724 81-0

Fax +49 (0) 7724 81-1309

info2@de.ebmpapst.com

www.ebmpapst.com

Nominal data

Type	4412 H	
Nominal voltage	VDC	12
Nominal voltage range	VDC	7 .. 14
Speed	min ⁻¹	4300
Power input	W	8.6
Min. ambient temperature	°C	-20
Max. ambient temperature	°C	70
Air flow	m ³ /h	240
Sound power level	B	6.0
Sound pressure level	dB(A)	50

ml = Max. load · me = Max. efficiency · fa = Running at free air · cs = Customer specs · cu = Customer unit
Subject to alterations



4412 H

DC axial compact fan

sickled blades (S series)

Technical features

Mass	0.250 kg
Dimensions	119 x 119 x 38 mm
Material of impeller	Fiberglass-reinforced PBT plastic
Housing material	Fiberglass-reinforced PBT plastic
Direction of air flow	Air exhaust over bars
Direction of rotation	Right, looking at rotor
Bearing	Ball bearings
Lifetime L10 at 40 °C	57500 h
Lifetime L10 at maximum temperature	27500 h
Connection line	Single strands AWG 24, TR 64, bared and tin-plated.
Motor protection	Protected against reverse polarity and locking.



4412 H

DC axial compact fan

sickled blades (S series)

Product drawing

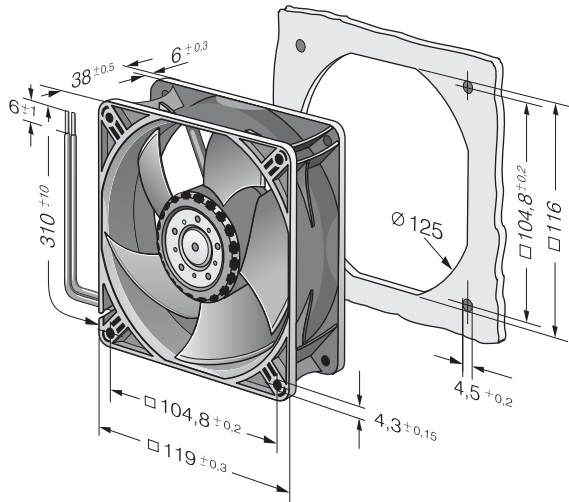

Charts

