

7112 N

DC axial compact fan



ebm-papst St. Georgen GmbH & Co. KG

Hermann-Papst-Str. 1
D-78112 St. Georgen
Phone +49 (0) 7724 81-0
Fax +49 (0) 7724 81-1309
info2@de.ebmpapst.com
www.ebmpapst.com

Nominal data

Type	7112 N	
Nominal voltage	VDC	12
Nominal voltage range	VDC	6 .. 15
Speed	min ⁻¹	2850
Power input	W	12.0
Min. ambient temperature	°C	-25
Max. ambient temperature	°C	72
Air flow	m ³ /h	360
Sound power level	B	6.2
Sound pressure level	dB(A)	53

ml = Max. load · me = Max. efficiency · fa = Running at free air · cs = Customer specs · cu = Customer unit
Subject to alterations



Technical features

Mass	0.620 kg
Dimensions	150 Ø x 38 mm
Material of impeller	Aluminum
Housing material	Aluminum. Housing with grounding lug for screw M4 x 8 (TORX).
Direction of air flow	Inlet over bars
Direction of rotation	Left, looking at rotor
Bearing	Ball bearings
Lifetime L10 at 40 °C	80000 h
Lifetime L10 at maximum temperature	37500 h
Connection line	Single strands AWG 22, TR 64, bared and tin-plated.
Motor protection	Protected against reverse polarity and locking.
Locked-rotor protection	Electronic blocking protection
Approval	VDE, CSA, UL, CE



Product drawing

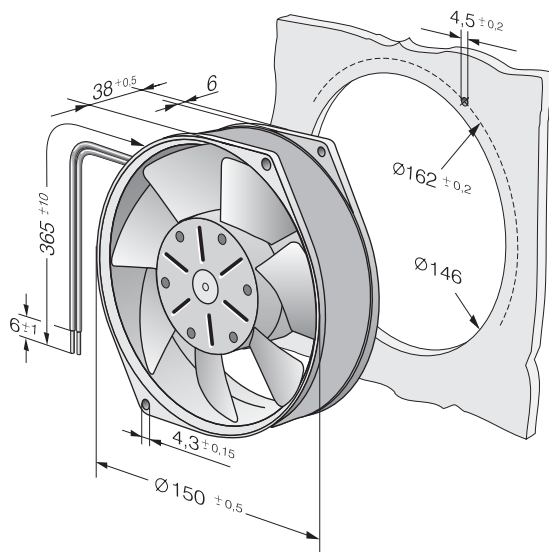

Charts: Air flow

