

7212 N

DC axial compact fan



ebm-papst St. Georgen GmbH & Co. KG

Hermann-Papst-Straße 1

D-78112 St. Georgen

Phone +49 7724 81-0

Fax +49 7724 81-1309

info2@de.ebmpapst.com

www.ebmpapst.com

Nominal data

Type	7212 N	
Nominal voltage	VDC	12
Nominal voltage range	VDC	6 .. 15
Speed	min ⁻¹	3050
Power input	W	12.0
Min. ambient temperature	°C	-25
Max. ambient temperature	°C	72
Air flow	m ³ /h	360
Sound power level	B	6.2
Sound pressure level	dB(A)	53

ml = max. load · me = max. efficiency · rfa = running at free air · cs = customer specs · cu = customer unit
Subject to alterations



Technical features

Dimensions	150 Ø x 55 mm
General description	<p>Particular design features: Optional Vario-Pro: Highly flexible software configuration for the fan ensures an easily customisable solution to meet the individual requirements of your application.</p> <p>General features: Materials: Housing made of aluminium, impeller made of fibreglass-reinforced PA; housing with grounding lug for M4 x 8 screw (Torx). Electronic commutation completely integrated. Protected against reverse polarity and locking. Connection via single strands AWG 22, TR 64, bared and tin-plated. Air exhaust over bars. Direction of rotation counter-clockwise seen on rotor. Mass: 725 g.</p>
Connection line	Single strands AWG 22, TR 64, bared and tin-plated.
Locked-rotor protection	Electronic blocking protection
Direction of rotation	Left, looking at rotor
Direction of air flow	Air exhaust over bars
Bearing	Ball bearings
Lifetime L10 at 40 °C	80000 h
Lifetime L10 at maximum temperature	37500 h
Mass	0.725 kg
Housing material	Aluminum. Housing with grounding lug for screw M4 x 8 (TORX).
Material of impeller	Fiberglass-reinforced PA plastic
Motor protection	Protected against reverse polarity and locking.
Approval	VDE, CSA, UL, CE

Product drawing

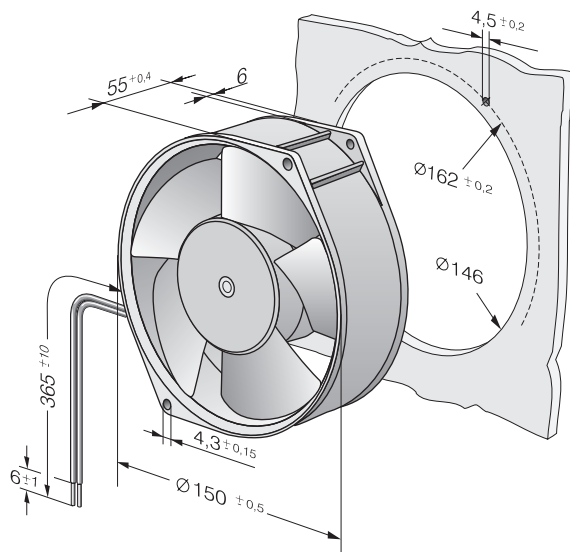

Charts: Air flow

