

**ebm-papst St. Georgen GmbH & Co. KG**

Hermann-Papst-Str. 1  
 D-78112 St. Georgen  
 Phone +49 7724 81-0  
 Fax +49 7724 81-1309  
 info2@de.ebmpapst.com  
 www.ebmpapst.com

**Nominal data**

Type	RER 120-26/18/2 TDP	
Nominal voltage	VDC	48
Nominal voltage range	VDC	36 .. 60
Speed	min <sup>-1</sup>	6300
Power input	W	92
Min. ambient temperature	°C	-20
Max. ambient temperature	°C	60
Air flow	m <sup>3</sup> /h	390
Sound power level	B	8.3

mi = max. load · me = max. efficiency · fa = running at free air · cs = customer specs · cu = customer unit  
 Subject to alterations

**Technical features**

<b>Mass</b>	0.43 kg
<b>Dimensions</b>	120 Ø x 54 mm
<b>Lifetime L10 at 40 °C</b>	50000 h
<b>Lifetime L10 at maximum temperature</b>	30000 h

## Product drawing

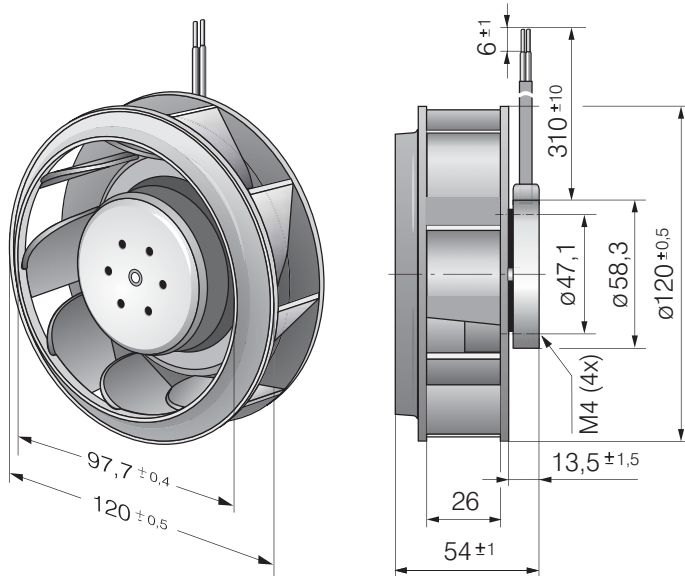

## Charts

