**ebm-papst St. Georgen GmbH & Co. KG**

Hermann-Papst-Str. 1

D-78112 St. Georgen

Phone +49 (0) 7724 81-0

Fax +49 (0) 7724 81-1309

info2@de.ebmpapst.com

www.ebmpapst.com

Nominal data

Type	RL 48-19/14	
Nominal voltage	VDC	24
Nominal voltage range	VDC	18 .. 26.4
Speed	min ⁻¹	4400
Power input	W	4.4
Min. ambient temperature	°C	-20
Max. ambient temperature	°C	70
Air flow	m ³ /h	28
Sound power level	B	5.7

mi = Max. load · me = Max. efficiency · fa = Running at free air · cs = Customer specs · cu = Customer unit
Subject to alterations

DC centrifugal compact fan

single inlet

Technical features

Mass	0.075 kg
Dimensions	76 x 76 x 27 mm
Material of impeller	Fiberglass-reinforced plastic
Housing material	Scroll housing of fiberglass-reinforced plastic.
Direction of air flow	Axial air intake, centrifugal air exhaust out of the outlet.
Bearing	Ball bearings
Lifetime L10 at 40 °C	60000 h
Lifetime L10 at maximum temperature	30000 h
Connection line	Single strands AWG 26, TR 64, bared and tin-plated.
Motor protection	Protected against reverse polarity and locking.
Locked-rotor protection	Electronic blocking protection
Approval	VDE, CSA, UL, CE



Product drawing

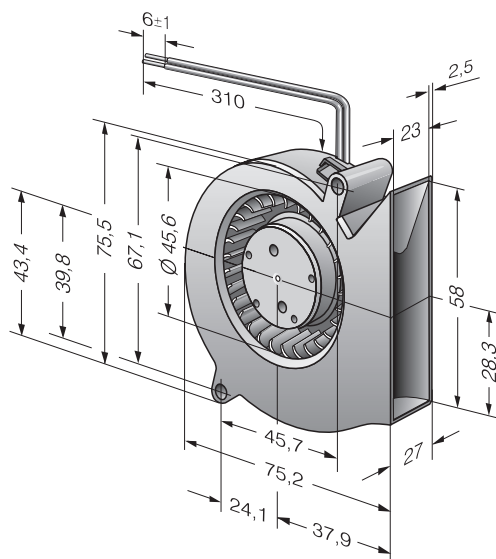

Charts: Air flow

