

Terminology

Main terms used for crystal units are described as follows:

Crystal wafer : A piece of quartz crystal cut as specified in terms of shape, dimensions and cutting angles.

Electrode : A conductive thin film vacuum-evaporated onto both sides of a crystal wafer to allow AC voltage to be applied.

Holder : A case housing a crystal wafer, electrode and support system, which prevents outside conditions from having any mechanical or environmental effect on its contents. The case also has terminals permitting the electrical connection of the electrode to an outside circuit.

Crystal unit : A mounted crystal wafer provided with electrodes and housed in a holder.

Overtone order : A number assigned from sequentially increasing integers for successively occurring overtone frequencies with a fundamental wave oscillation of 1 in a specified oscillation mode. An overtone frequency in a slide or extension mode can approximate the value obtained by multiplying the fundamental wave frequency by an integer.

Series resonance frequency : Lower frequency of the two given when the electrical impedance of a crystal unit becomes resistant near its resonance point.

Load capacitance : Effective series capacitance measured from the terminals of a crystal unit to the oscillation circuit and determined as a condition when using a crystal unit in an oscillation circuit. The operating frequency is determined by the

electrical characteristics of a crystal unit and the load capacitance.

Nominal frequency : Nominal value expressed in terms of frequency.

Series resonance : Condition of resonance in the case of limitless load capacitance

Frequency tolerance : Deviation from the nominal frequency expressed as a ratio to nominal frequency.

Equivalent series resistance : Equivalent resistance for series resonance frequency. Simply called equivalent resistance when no risk of confusion is possible.

Load resonance resistance : Resistance for the lower frequency of the two given when the electrical impedance becomes resistant near the resonance point of a circuit, with the load capacitance connected to a crystal unit in series.

Operating temperature range : Temperature range within which crystal units operate under specified conditions.

Drive level : Electric-power or current level under the specified conditions of a crystal unit.

Main mode and spurious : When there are some resonance frequencies near the nominal frequency, main mode indicates the most prominent resonance frequency and spurious indicates other resonance frequencies.

Internal Structure of Crystal Units

To effectively pick up the desired energy by changing the mechanical vibration to an electrical signal, the system supporting the crystal wafer must as little as possible suppress vibration.

Fig. 1 shows a typical example of the internal structure for a

thickness-shear mode crystal unit at the minimum displacement of mechanical vibration on the wafer.

Furthermore, the holder is hermetically sealed to prevent deterioration of the crystal unit's performance.

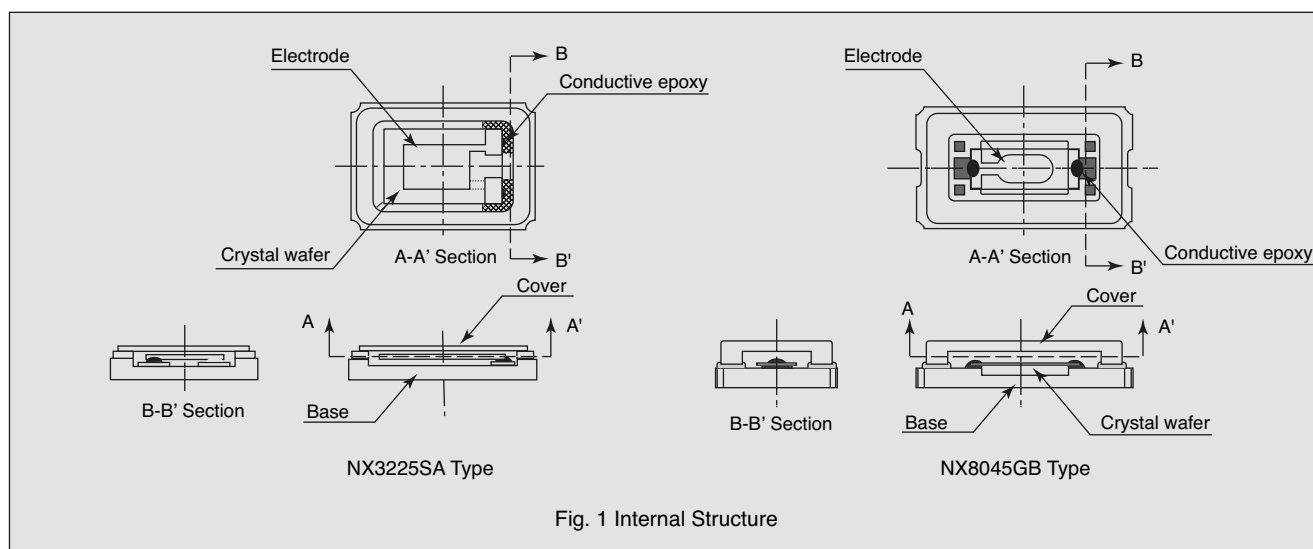

Fig. 1 Internal Structure

■ Cutting Angles and Vibration Mode

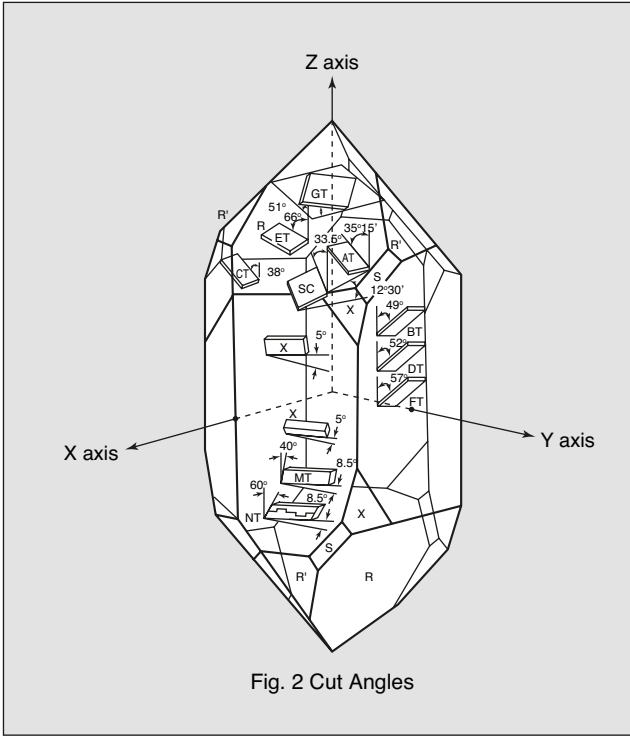

Fig. 2 Cut Angles

Cutting angles differ depending upon the applications (oscillation frequencies and electrical characteristics). Fig. 2 shows the main cutting angles. And Table 1 shows their vibration modes, frequency ranges and capacity ratios (typical values).

Taking the most popular AT-cut crystal wafer, for example, the wafer plane makes an angle of 35°15' to the Z-axis. In the case of 28 MHz fundamental-wave thickness-shear vibration, the wafer thickness is approximately 0.06mm.

● Table 1 Basic Characteristics

Vibration Mode	Cut	Frequency Range (kHz)	Frequency Formula (kHz)	Capacitance Ratio (Typical)	
Thickness-shear 	Overtone Order	AT Fundamental	800 to 5000 2000 to 80000	1670/t 1670/t	300 to 450 220
		AT 3rd Overtone AT 5th Overtone AT 7th Overtone AT 9th Overtone	20000 to 90000 40000 to 130000 100000 to 200000 150000 to 230000	1670 × n/t	n ² × 250 n : Overtone Order
	BT Fundamental	2000 to 35000	2560/t		
Length-width-flexure (Tuning fork) 	+2°X	16 to 100	700 × w/ℓ ²	450	
Length-width-flexure 	XY	1 to 35	5700 × t/ℓ ²	600	
	NT	4 to 100	5000 × w/ℓ ²	900	
Length-extensional 	+5°X	40 to 200	2730/ℓ	140	
Face-shear 	CT DT SL	250 to 1000	3080/ℓ	400	
		80 to 500	2070/ℓ	450	
		300 to 1100	460/ℓ	450	

Cutting Angles and Frequencies

Because of their stable oscillation frequency, crystal units are widely used, but they must also demonstrate superior temperature characteristics.

However, as with ordinary materials, a crystal wafer cut for a crystal unit is influenced by temperature change, causing its oscillation frequency to change. The level of change in the oscillation frequency (frequency / temperature characteristics) varies depending on the cutting angle. Fig. 3 shows typical frequency / temperature characteristics for various cutting angles. Fig. 4 shows how to make crystal units which have superlative temperature characteristics, taking the AT-cut crystal wafer (the most popular crystal wafer) as an example.

Fig. 4 shows three different temperature characteristics for different cutting angles. You can easily find that curve (2) provides the smallest rate of frequency change against temperature change near normal temperatures and therefore, crystal units represented by this curve have excellent characteristics suited for the most

usual applications within a range of -10 to +60 ° C. On the other hand, over a wider temperature range of -55 to +105 ° C, for example, curve (1) shows better characteristics and enables the maintenance of favorable frequency changes. Therefore, it is necessary to determine the most appropriate temperature characteristics taking into consideration the application, required operating temperature ranges, manufacturing and economic constraints.

Fig. 5 shows frequency / temperature characteristics when changing AT-cut angles with an increment of 2'. The cutting angle allowance is determined by the operating temperature range and allowable frequency tolerance.

Fig. 6 shows cutting angle allowances (impracticality) corresponding to frequency / temperature characteristics. This figure shows the degree of difficulty in manufacture (cost) and reveals impractical zones and limitations.

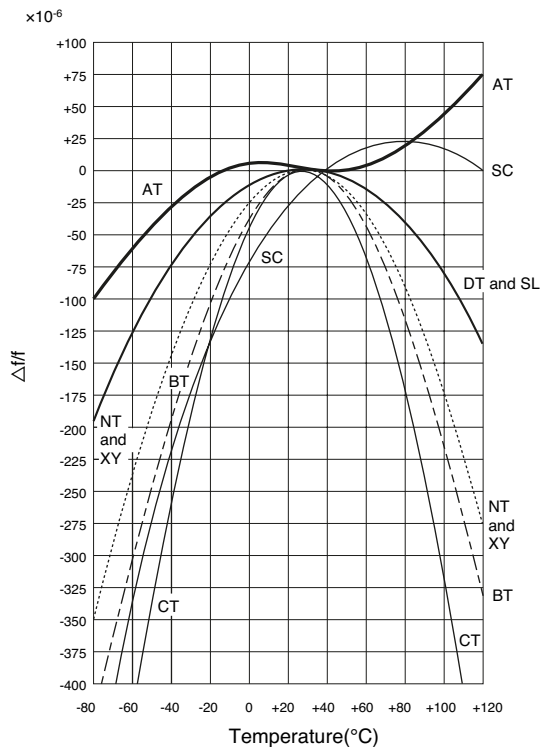

Fig. 3 Theoretical Frequency / Temperature Curves of Various Cuts

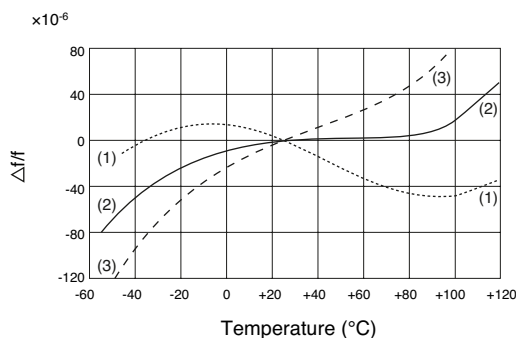

Fig. 4 Characteristics of Frequency / Temperature (AT-cut)

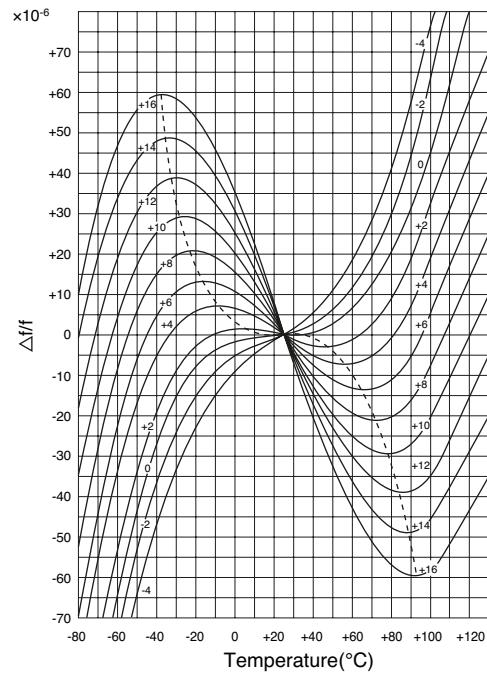

Fig. 5 Frequency / Temperature Curves (AT-cut)

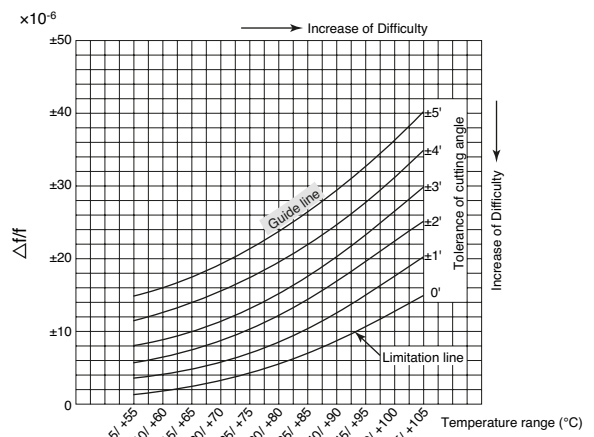

Fig. 6 Frequency Stability Guidance

■ Equivalent Circuits and Characteristics of Crystal Units

The electric equivalent circuits of crystal units are generally expressed as shown in Fig. 7, and the four equivalent constants are labeled as follows:

- L_1 : Equivalent series inductance
- C_1 : Equivalent series capacitance
- R_1 : Equivalent series resistance
- C_0 : Parallel capacitance

The major characteristics of crystal units are introduced using these equivalent constants. As an example, Fig. 8 shows the frequency / impedance characteristics.

Typical frequencies and performance of crystal units are shown below.

$$f_0 = \frac{1}{2\pi\sqrt{L_1 C_1}} \quad \text{Series resonance frequency}$$

$$f_a \approx f_0 \left(1 + \frac{C_1}{2C_0}\right) \quad \text{Antiresonance frequency}$$

$$r = \frac{C_0}{C_1} \quad \text{Capacitance ratio}$$

$$Q = \frac{2\pi f_0 L_1}{R_1} = \frac{1}{2\pi f_0 C_1 R_1}$$

Oscillation circuits are capacitive in general, and can be treated as series circuits with a negative resistance (-R) and load capacitance (C_L) as shown in Fig. 9.

Assuming that frequencies are f_L and $f_s (= f_0)$ respectively when the value of the load capacitance is C_L , for a series circuit the following relationship holds.

$$\frac{f_L - f_s}{f_s} = \frac{C_1}{2(C_0 + C_L)}$$

Fig. 10 gives an example.

In comparison with the fundamental mode oscillation, the rate of frequency change corresponding to the C_L value of the overtone mode oscillation is lower because the C_1 values of the overtone mode oscillation are smaller.

When the frequencies are the same, the C_1 value of common small-size crystal units is smaller than that of large-size crystal units. For this reason, the smaller the size of a crystal unit, the lower its rate of frequency change becomes, due to the load capacitance.

When the load capacitance (C_L) is connected to the crystal unit in series as shown in Fig. 9, the equivalent resistance increases according to the following equation:

$$R'_1 = R_1 \left(1 + \frac{C_0}{C_L}\right)^2$$

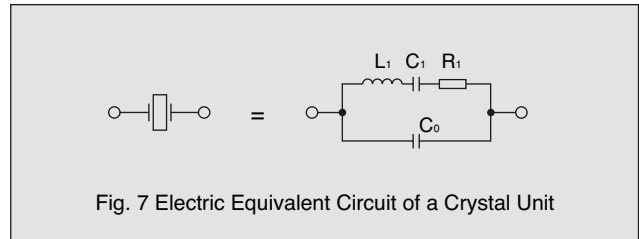

Fig. 7 Electric Equivalent Circuit of a Crystal Unit

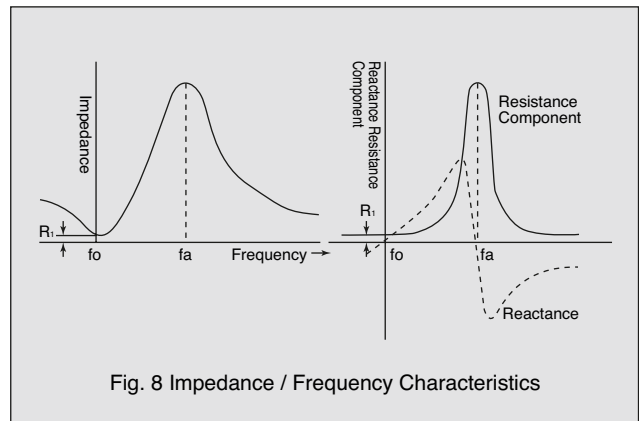

Fig. 8 Impedance / Frequency Characteristics

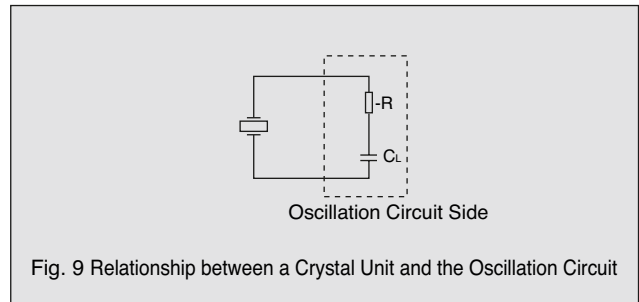

Fig. 9 Relationship between a Crystal Unit and the Oscillation Circuit

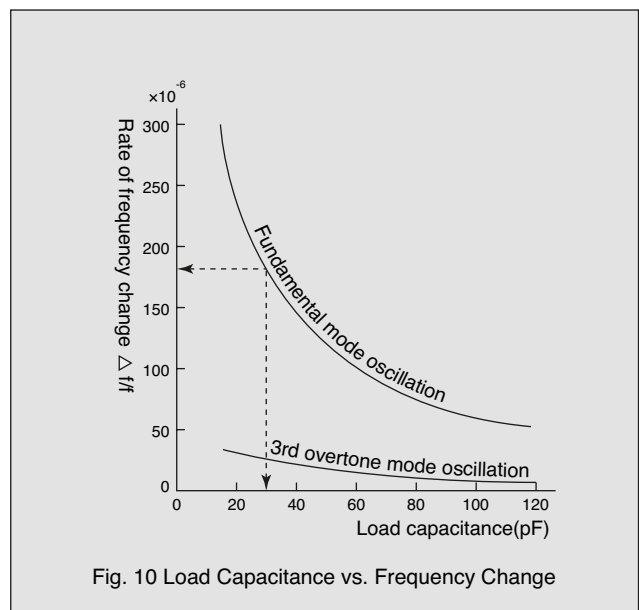

Fig. 10 Load Capacitance vs. Frequency Change