

Savvi™ Embedded Bluetooth Antennas

2.4—2.5 GHz

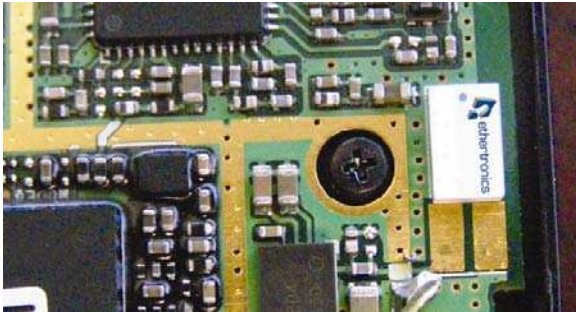

Ethertronics' Savvi series of Isolated Magnetic Dipole™ (IMD) antennas deliver on the key needs of device designers for higher functionality and performance in smaller/thinner designs. These innovative antennas provide compelling advantages for Bluetooth enabled cell phones, media players and other mobile devices.

TECHNOLOGY ADVANTAGES

Real-World Performance and Implementation

Ceramic antennas may look alike on the outside, but the important difference is inside. Other antennas may contain simple PiFA or monopole designs that interact with their surroundings, complicating layout or changing performance with use position. Ethertronics' antennas utilize patented IMD technology to deliver a unique size and performance combination.

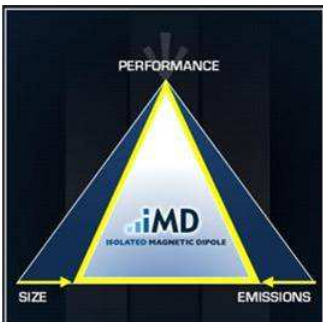

Stays in Tune

High RF isolation means IMD antennas resist detuning regardless of usage position. And one standardized part can typically be placed in a variety of locations.

Smallest Effective Size

IMD antennas require a smaller keep-out area for surrounding components, leading to a smaller effective size.

High Performance

IMD's high efficiency and simple design rules lower development risk and speed time-to-market without sacrificing performance. Plus, high RF selectivity eliminates the cost and space for band-pass circuitry.

More information is available on our Website at www.ethertronics.com/resources/.



KEY BENEFITS

DESIGN ADVANTAGES

Best in Class Performance—Smallest Occupied Volume

- Powerful combination of 81% peak efficiency and simple implementation guidelines.
- Minimal ground clearance and component "keep out" areas. Very low component height.
- High selectivity eliminates the cost for additional filters and frees up board space

High Tolerance to Frequency Shifts

- IMD's high RF isolation resists antenna detuning that otherwise can impair reception.
- Single part works for various PCB sizes and layouts.

Quicker Time-to-Market

- Fewer design modifications required to pass RF test suite.
- Simpler implementation—no matching networks.

RoHS Compliant

- Antennas comply with appropriate RoHS Directives.

END USER ADVANTAGES

Superior Range

- Greater antenna efficiency means longer range and a better end user experience.

Exceptional Coverage

- Better coverage delivers more reliable wireless connections for mobile phones, laptops, stereo headsets, cars, media players, audio systems and more.

SERVICE AND SUPPORT

Extensive RF Experience

- Our Savvi ceramic antennas are supported by extensive application notes, and when needed, by the expertise of RF engineers who have integrated hundreds of antenna designs into wireless devices.

Global Operations & Design Support

- Ethertronics' global operations encompass an integrated network of design centers that provide local customer support.

PRODUCT: Bluetooth® Antenna

Ethertronics' Savvi™ Bluetooth Embedded Antenna Specifications

Ethertronics produces a wide variety of standard and custom antennas to meet user needs. Below are the typical specs for a Bluetooth application.

Electrical Specifications

Typical Characteristics
(inside an enclosure)

BT Antenna	2.4–2.5 GHz
Peak Gain	1.39 dBi
Average Efficiency	78%
VSWR Match	2.0:1 max
Feed Point Impedance	50 ohms unbalanced
Power Handling	.5 Watt cw
Polarization	Linear

Mechanical Specifications

Size	8x3x1.3mm
Mounting	Surface mount
Packaging	Tape & Reel M830310: Minimum Order Quantity of 99,000 pcs. Order multiples of 4,500 pcs. M830310-1K: Minimum Order Quantity of 1,000 pcs. Order multiples of 1,000 pcs.

Typical Efficiency, Return Loss

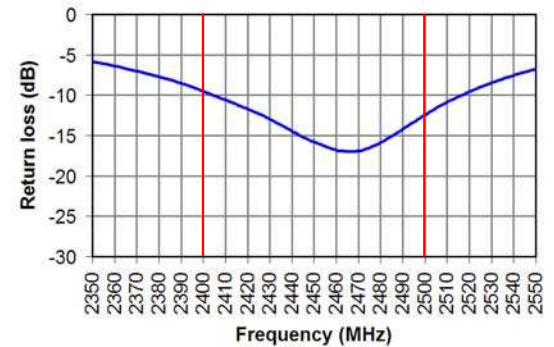
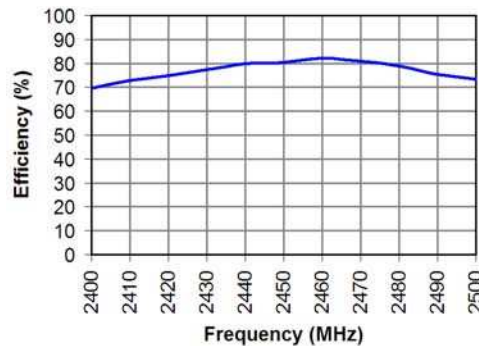

Antenna Radiation Patterns

2.4 GHz Band

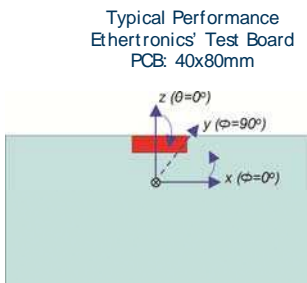

Phi = 0° Plane

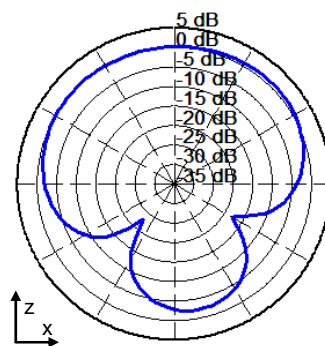

Phi = 90° Plane

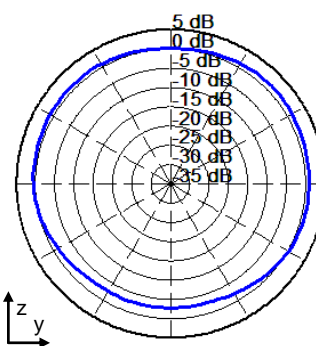

Theta = 90° Plane

