



THIS INFORMATION IS CONFIDENTIAL AND PROPRIETARY TO CW INDUSTRIES INCORPORATED AND ITS AFFILIATES. IT MAY NOT BE DISCLOSED TO ANYONE, OTHER THAN CW INDUSTRIES PERSONNEL, WITHOUT WRITTEN AUTHORIZATION FROM CW INDUSTRIES INCORPORATED, SOUTHAMPTON, PENNSYLVANIA USA.

Rating	16A 125VAC, 10A 277VAC		Mounting Hole														
	3/4HP 125/277VAC																
	21A 14V DC		<table border="1"> <thead> <tr> <th>Thickness</th> <th>X</th> <th>Y</th> </tr> </thead> <tbody> <tr> <td>0.75 - 1.25</td> <td>21.2 + 0.1</td> <td>36.6 + 0.1</td> </tr> <tr> <td>1.25 - 2.00</td> <td>21.2 + 0.1</td> <td>36.8 + 0.1</td> </tr> <tr> <td>2.00 - 3.00</td> <td>21.2 + 0.1</td> <td>37.0 + 0.1</td> </tr> </tbody> </table>		Thickness	X	Y	0.75 - 1.25	21.2 + 0.1	36.6 + 0.1	1.25 - 2.00	21.2 + 0.1	36.8 + 0.1	2.00 - 3.00	21.2 + 0.1	37.0 + 0.1	SPDT ON - ON
Thickness	X	Y															
0.75 - 1.25	21.2 + 0.1	36.6 + 0.1															
1.25 - 2.00	21.2 + 0.1	36.8 + 0.1															
2.00 - 3.00	21.2 + 0.1	37.0 + 0.1															
Contact Resistance	50m ohm max.																
Insulation Resistance	DC 500V 100M ohm min.																
Dielectric Strength	AC 1500V 1 minute																
Operating Temperature	-20 °C ~ 85 °C																

BASE COLOR: Black
 BUTTON COLOR: Black

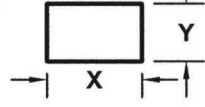
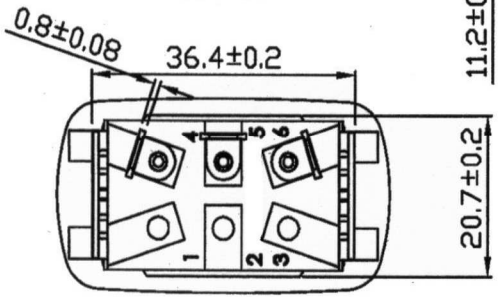
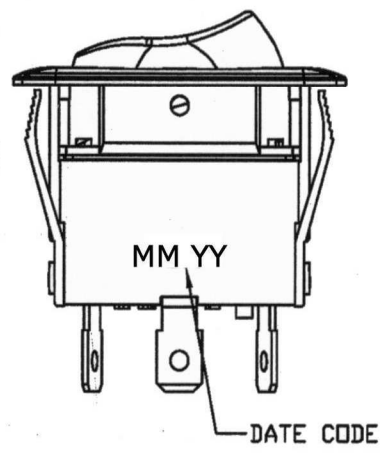
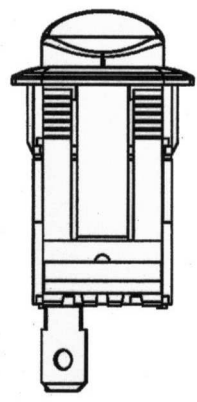
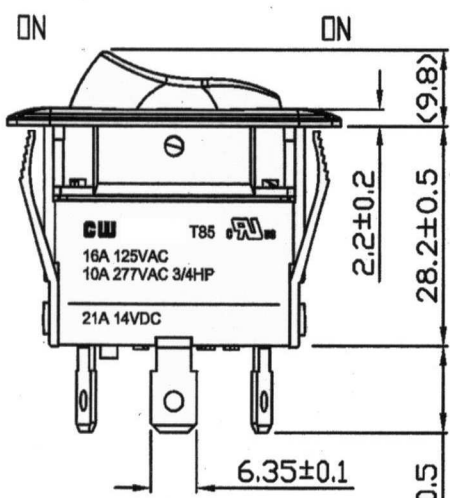
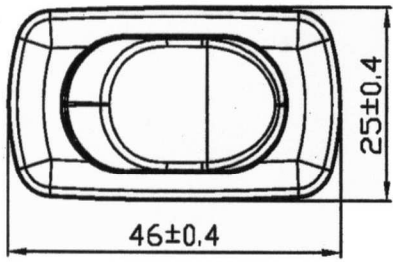

RoHS Compliant

1 | Added 3/4HP 125/277VAC to rating. 1/31/11.

CW INDUSTRIES
 Southampton, Pa. 18966
 Tel 215.355.7080/www.cwind.com

Date Drawn: 1/31/11
 Rev. 1
 Title: **ROCKER SWITCH**

Unit: mm
 Checked By: **G.GULD**
 CW P/N: **GRB263C001NNN**