

G-02-75-A

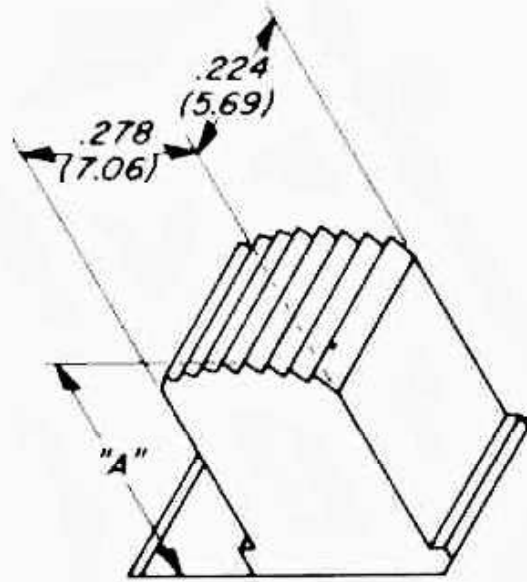

G-02-73

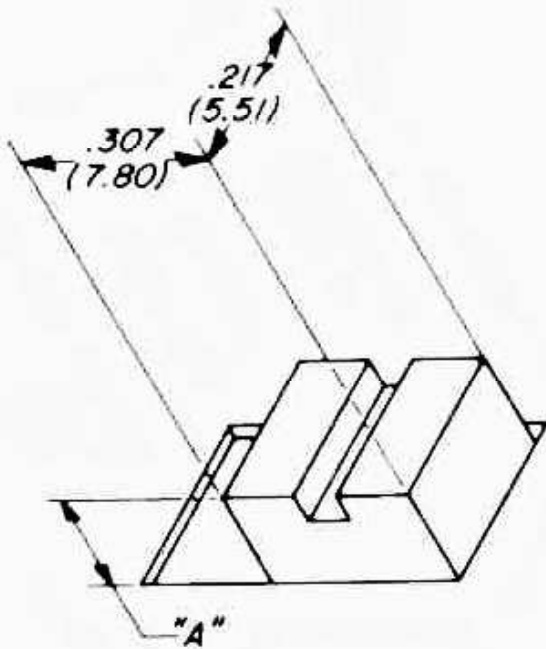

G-02-150

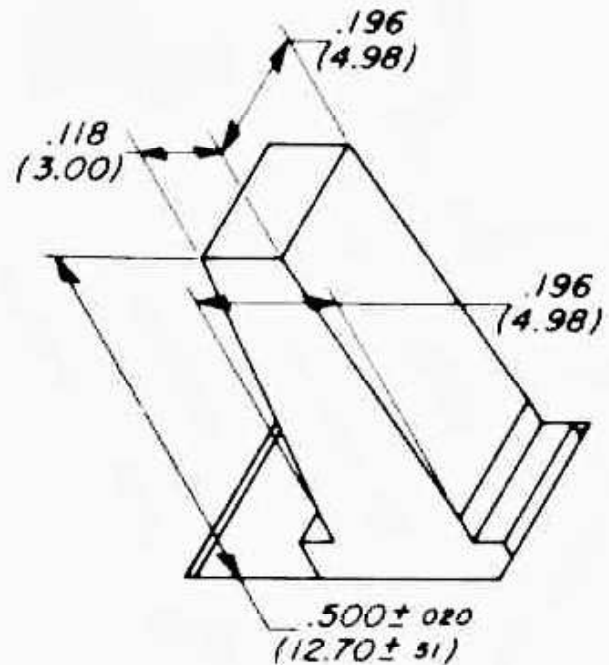

G-02-80