

Wire-wound Chip Power Inductors (CB series)

CB2518T330K

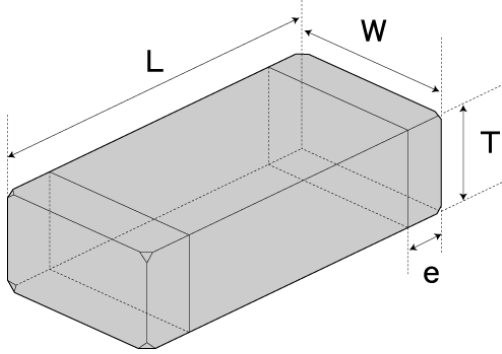

■ Features

- Item Summary
33 μ H(\pm 10%), 130mA, 460mA, 1007
- Lifecycle Stage
Mass Production
- Standard packaging quantity (minimum)
Taping 2000pcs

■ Products characteristics table

CaseSize (EIA/JIS)	1007/2518
Inductance	33 μ H(\pm 10%)
Inductance Measuring Frequency	2.52MHz
Rated Current -Saturation Current	130mA
Rated Current -Temperature Rise Current	460mA
DC Resistance (max)	0.91 Ω
Avg. of DC.Resistance	0.7 Ω
Temperature Range	-40°C to 105°C
Self-resonant Frequency (min)	15MHz
RoHS Compliance	Yes
Halogen Free	Yes
Soldering Method	Reflow

■ External Dimensions

L	2.5mm \pm 0.2
W	1.8mm \pm 0.2
H	1.8mm \pm 0.2

2014.03.05

The data is reference only. Electrical characteristics vary depending on environment or measurement condition.
 TAIYO YUDEN reserves the right to make change to the Date at any time without notice.
 Before making final selection, please check product specification.