

Leaded Ferrite Bead Inductors

FBR07VA850SB-00

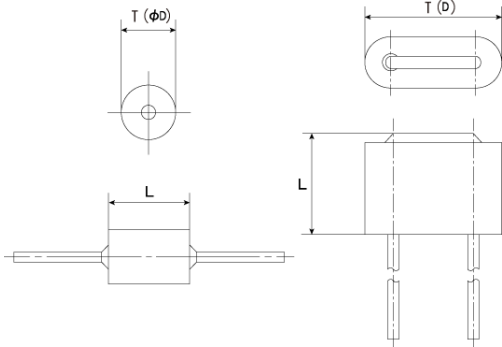

■ Features

- Item Summary
85Ω, 7A, Leaded
- Lifecycle Stage
Mass Production
- Standard packaging quantity (minimum)
Taping 2000pcs

■ Products characteristics table

External Dimensions	5.5(-) × 7.5(±0.5)mm
Impedance (max)	85Ω
Impedance Measuring Frequency	100MHz
Rated Current	7A
DC Resistance (max)	0.01Ω
Temperature Range	-25°C to 85°C
Resistance	1MΩ min.
RoHS Compliance	Yes
Soldering Method	Wave

■ External Dimensions

L	5.5mm -
T	7.5mm ±0.5

■ Typical Characteristics Fig.

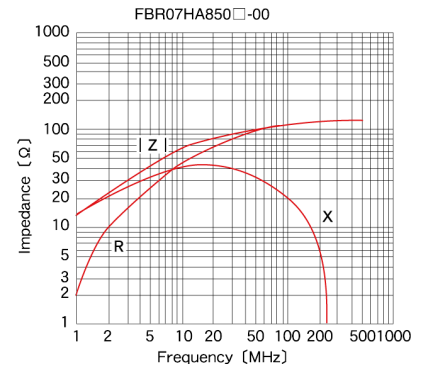

2014.03.05

The data is reference only. Electrical characteristics vary depending on environment or measurement condition.
 TAIYO YUDEN reserves the right to make change to the Date at any time without notice.
 Before making final selection, please check product specification.