

Chip Bead Inductors for Power Lines (FB series M type)

FBMH4532HM132-T

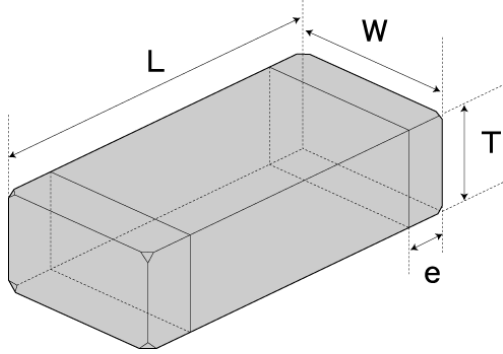

■ Features

- Item Summary
1300Ω, 3A, 1812
- Lifecycle Stage
Mass Production
- Standard packaging quantity (minimum)
Taping 2000pcs

■ Products characteristics table

CaseSize (EIA/JIS)	1812/4532
Impedance	1300Ω
Impedance Measuring Frequency	100MHz
Rated Current	3A
DC Resistance (max)	0.06Ω
Temperature Range	-40°C to 125°C
RoHS Compliance	Yes
Halogen Free	Yes
Soldering Method	Reflow/Wave

■ External Dimensions

L	4.5mm ±0.4
W	3.2mm ±0.3
T	3.2mm ±0.3
e	0.9mm ±0.6

■ Typical Characteristics Fig.

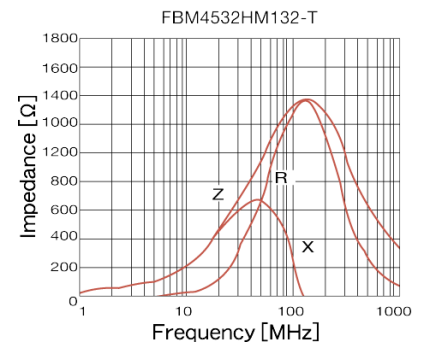

The data is reference only. Electrical characteristics vary depending on environment or measurement condition. TAIYO YUDEN reserves the right to make change to the Date at any time without notice. Before making final selection, please check product specification.

2014.03.05