

# 8000 series

## Momentary or alternate action pushbutton switches

*Distinctive features and specifications*



Bushing  $\varnothing$  6,35 (1/4) and  $\varnothing$  11,9 (15/32)

UL approved

### ELECTRICAL SPECIFICATIONS

- Max. current/voltage rating with resistive load :
  - silver contacts : 4A 30VDC
  - gold plated contacts : 0,4VA max. 20VAC or DC
- Initial contact resistance : 10 m $\Omega$  max.
- Insulation resistance : 1.000 M $\Omega$  min. at 500VDC
- Dielectric strength :
  - 1.000 Vrms 50 Hz min. between terminals
  - 2.000 Vrms 50 Hz min. between terminals and frame
- Electrical life : 30.000 cycles at full load

### MATERIALS

- Case : diallylphthalate (DAP)
- Actuator : brass, nickel plated
- Bushing : brass, nickel plated
- Housing : stainless steel
- Contacts
  - A** : silver
  - AD** : silver, gold plated
  - CD** : brass, gold plated
- Terminal seal : epoxy

### GENERAL SPECIFICATIONS

- Torque : 1,25 Nm (.922 Ft.lb) max. applied to nut
- Total travel : 2,70 mm (.106)
- Operating temperature : -40°C to +85°C

### AGENCY APPROVAL



**Availability** : consult factory for details of approved models.

**Marking** : to order switches marked UL, complete appropriate box of ordering format.

# 8000 series

## Momentary or alternate action pushbutton switches

Overview

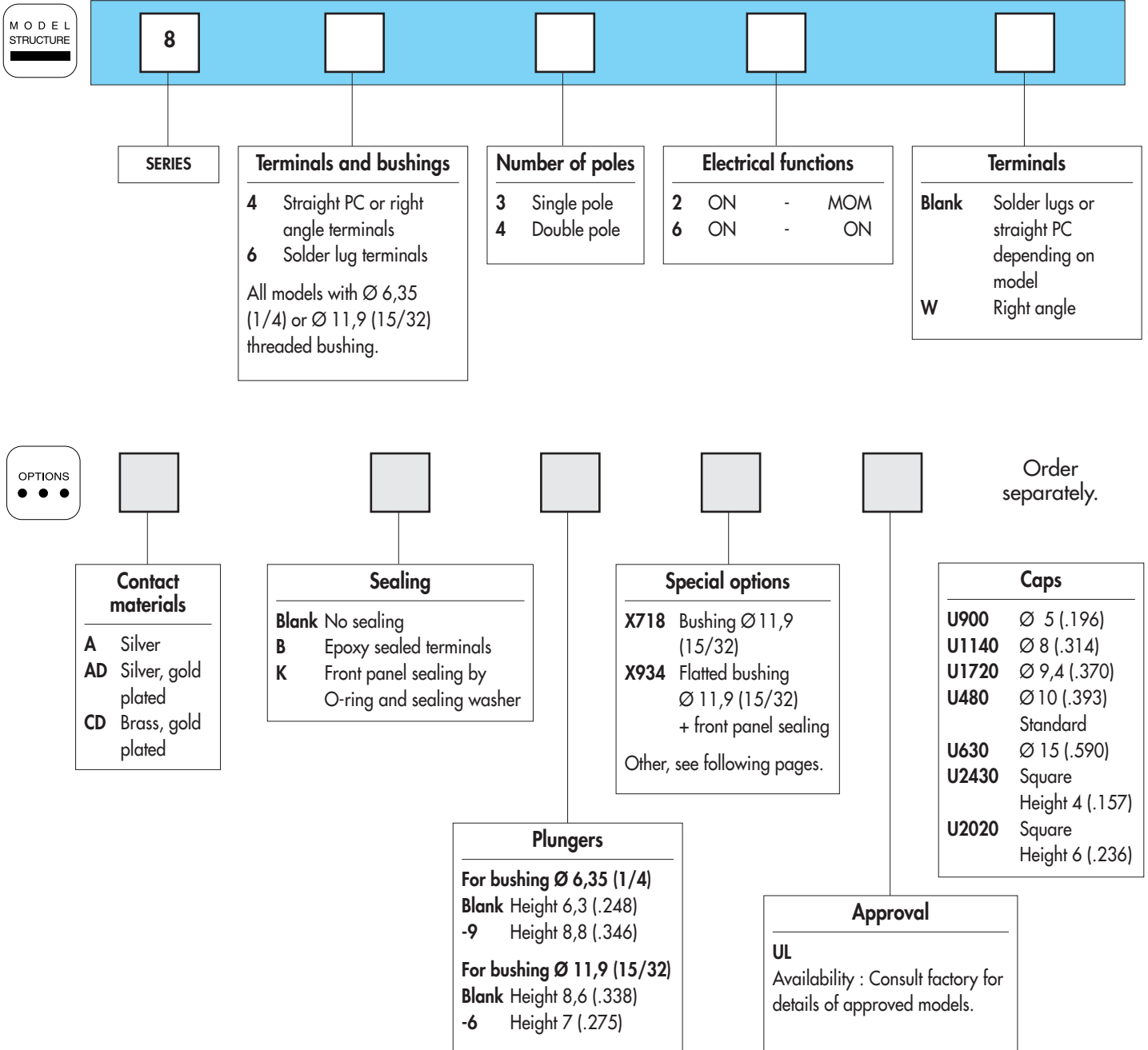

### ABOUT THIS SERIES

On the following pages, you will find successively :

- model structure of switches
- options in the same order as in above chart

**Dimensions** : first dimensions are in mm while inches are shown as bracketed numbers.



**Sealing boots** are available to protect the switches against dust and water. They are presented in section H.



**Mounting accessories** : standard hardware supplied with all models : 2 hex nuts 8 mm (.314) across flats, 1 locking ring and 1 lockwasher.

Standard and special hardware available are presented in section I.



**Packaging unit** : 50 pieces, except 8000W (25 pieces).

# 8000 series

## Momentary or alternate action pushbutton switches

Threaded bushing  $\varnothing 6,35 (1/4)$

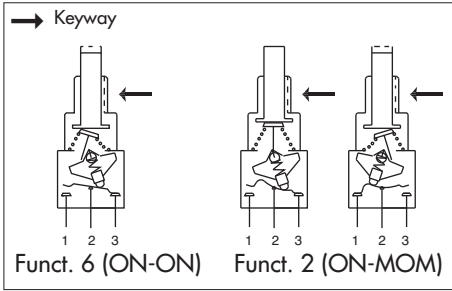

- Solder lug, straight PC or right angle terminals
- 1 and 2 pole configurations
- Button returns in upper position after actuation.

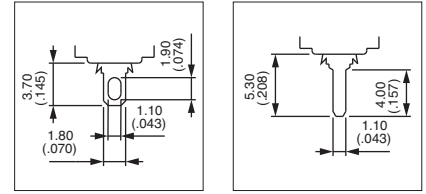

### MODEL STRUCTURE

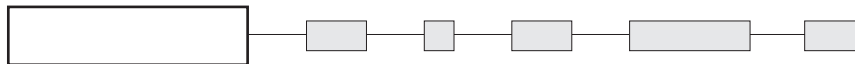

Shown with standard plunger

### Solder lug terminals : 8600



Single pole  
**8632**  
**8636**

Double pole  
**8642**  
**8646**



2-3



1-2

ON

MOM

2-3

1-2

ON

MOM

ON

ON

→ Keyway

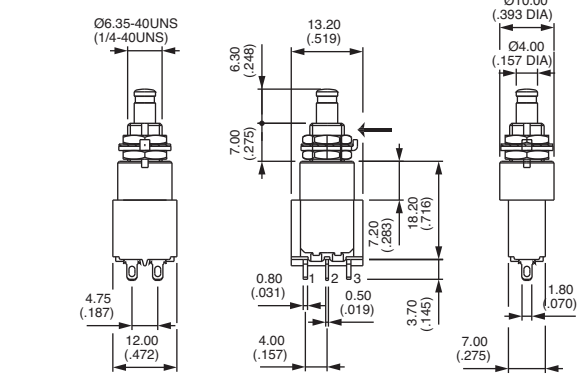

### Straight PC terminals : 8400



Single pole  
**8432**  
**8436**

Double pole  
**8442**  
**8446**



2-3



1-2

ON

MOM

2-3

1-2

ON

MOM

ON

ON

→ Keyway

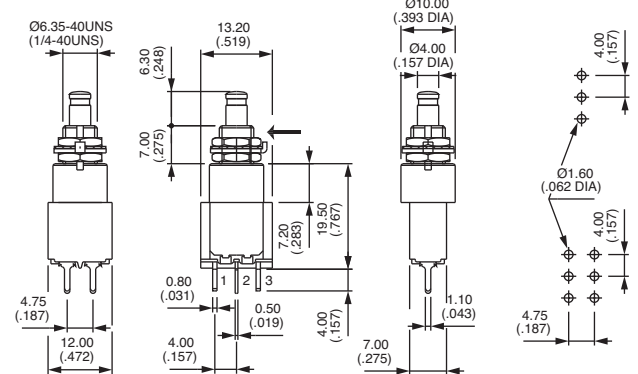

### Right angle terminals - horizontal : 8400W



Single pole  
**8432W**  
**8436W**

Double pole  
**8442W**  
**8446W**



2-3



1-2

ON

MOM

2-3

1-2

ON

MOM

ON

ON

→ Keyway

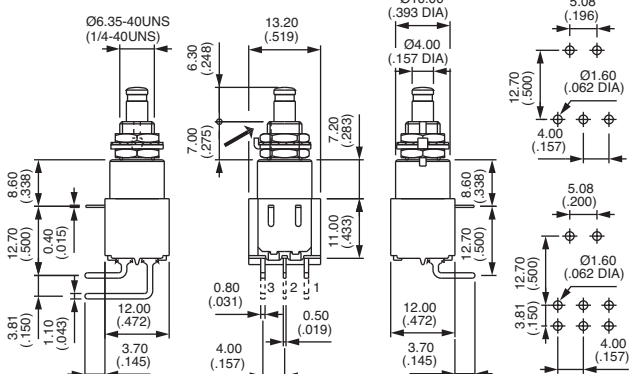



# 8000 series

Momentary or alternate action pushbutton switches

## PANEL CUT-OUT

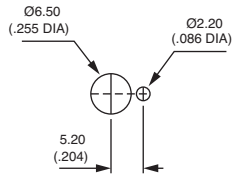

Standard

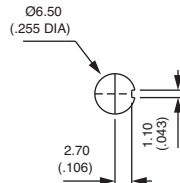

With K sealing option

## CONTACT MATERIALS



- A Silver
- AD Silver, gold plated
- CD Brass, gold plated

## SEALING



- Blank No sealing
  - B Epoxy sealed terminals
  - K Front panel sealing by one O-ring and sealing washer. Protects the switch against water and dust. Panel seal withstands 1 bar pressure.
  - KB Combined sealings
- Sealing boot : see section H.

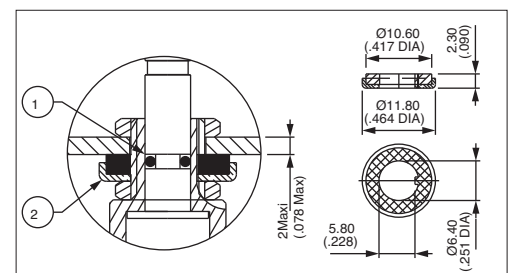
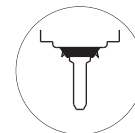

- ① O-ring
- ② Sealing washer

# 8000 series

Momentary or alternate action pushbutton switches



## PLUNGERS

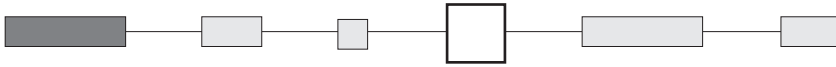

For  $\varnothing 6,35$  (1/4) bushing

Dash compulsory before plunger code.

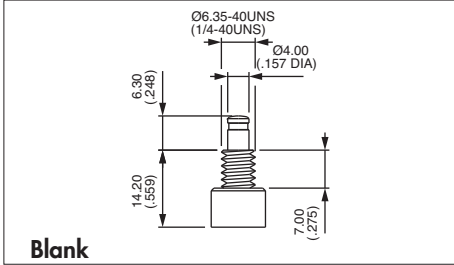

Blank

Standard

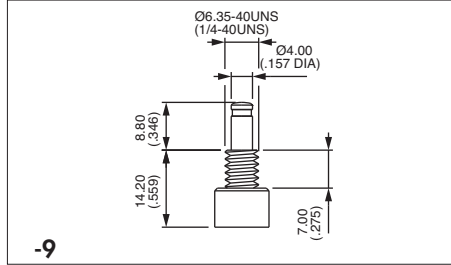

-9

For  $\varnothing 11,9$  (15/32) bushing (X718 models)

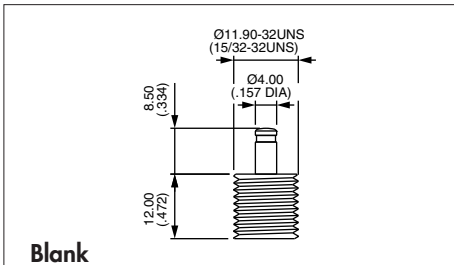

Blank

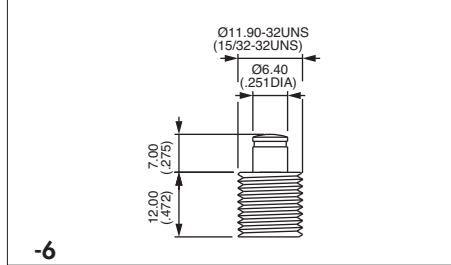

-6

## SPECIAL OPTIONS

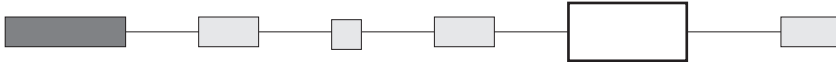

**X601** Silver plated brass contacts

Current/voltage rating for an electrical life of 20.000 cycles : 0,5A 30VDC.  
Minimum quantity : 5.000 pieces per model and shipment.

**X718** Bushing  $\varnothing 11,9$  (15/32)  
For all basic models (solder lug straight PC or right angle terminals)  
Available with plungers 13 and 6.  
K sealing option available.

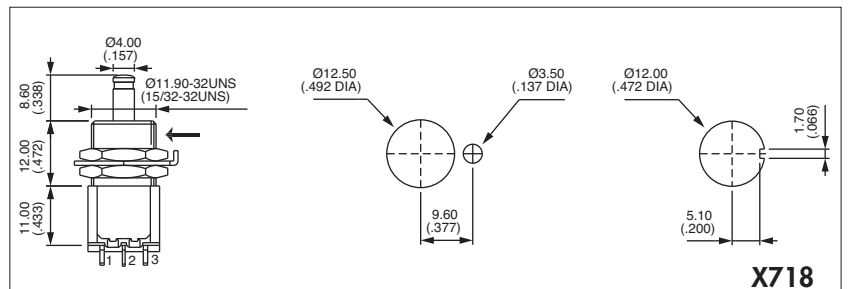

**X718**

**X748** Snap-in mounting. Consult factory  
Panel cut-out 15 x 12,5 (.59 x .492)

**X934** Flatted bushing  $\varnothing 11,9$  (15/32) + sealing by two O-rings  
(for plunger -6 only). Epoxy sealed terminals.

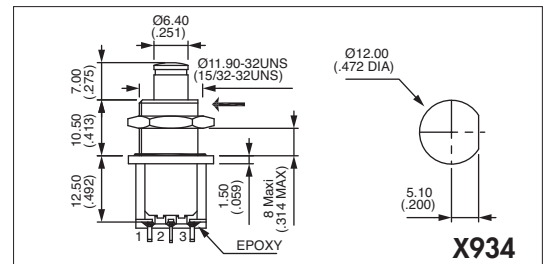

**X934**

B2



# 8000 series

## Momentary or alternate action pushbutton switches

### APPROVAL

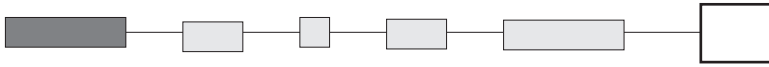

### UL

**Availability** : consult factory for details of approved models.

**Marking** : to order switches marked UL, complete above box with "UL".

### CAPS

Order separately.

The caps below are for  $\varnothing$  4 mm plungers (standard and -9), except U2600.

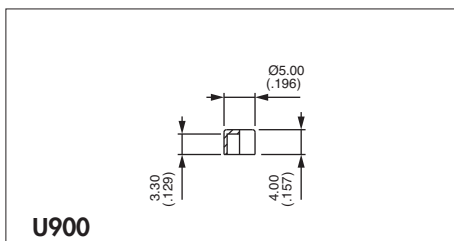

**U900**

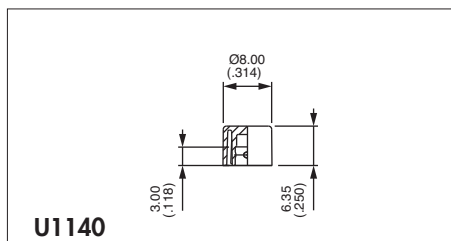

**U1140**

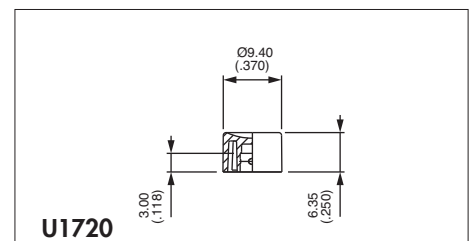

**U1720**

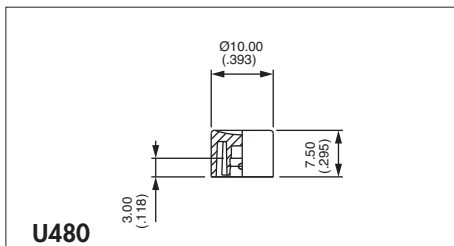

**U480**

Standard

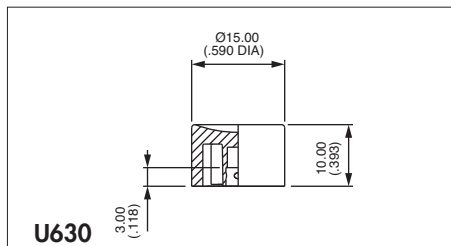

**U630**

Cap colours			
Replace last "0" by number			
1	blue	5	yellow
1/4	dark blue	6	red
2	black	7	ivory
3	green	7/1	white
4	grey	9	orange

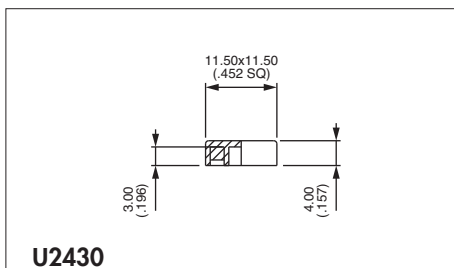

**U2430**

Square

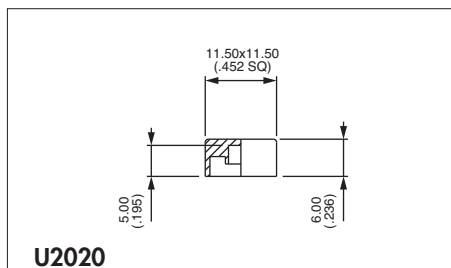

**U2020**

Square

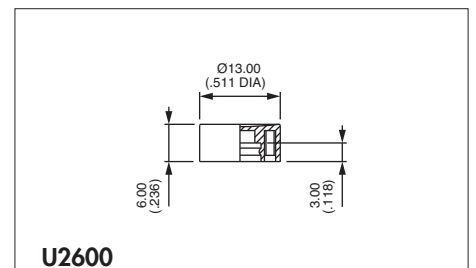

**U2600**

For large plunger -6 only.

### DRESS NUTS

Chrome plated. Order separately.

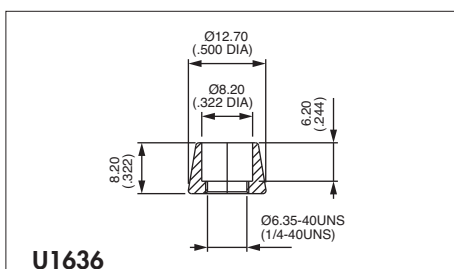

**U1636**

For cap U1140

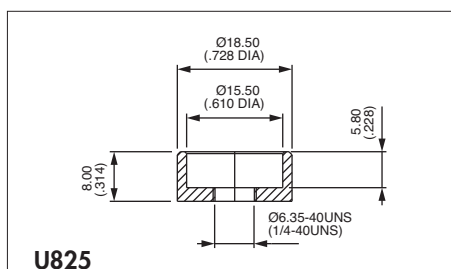

**U825**

For cap U630

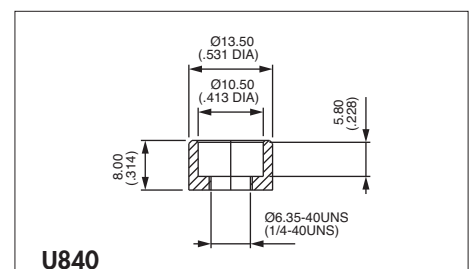

**U840**

For cap U480