

KL series

Locking power rocker switches

Distinctive features

Unlocking actuator

Each KL rocker switch includes an unlocking actuator.

This actuator must be pressed to activate the protected function of the rocker. Moreover, two frames protect the unlocking actuator from untimely activation.

This intuitive and secured ergonomics is patented by APEM.

Unlocking actuator Protection frames



2 position versions (electrical functions 1, 5 and 6)

Press unlocking actuator to reach the protected position

Press opposite part of actuator to leave the protected position

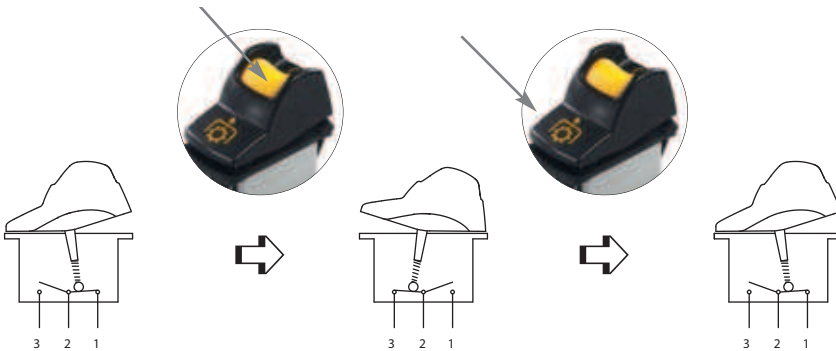

3 position versions (electrical functions 7, 8, 9 4, 4-1R)

Press unlocking actuator to reach the protected position

Press opposite part of actuator to leave the protected position

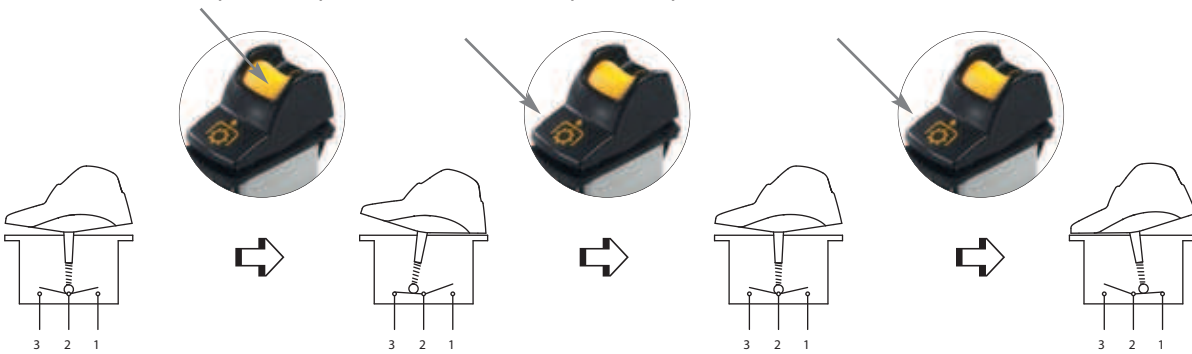



- One protected position
- Patented intuitive ergonomics
- Wide choice of colours
- Laser etched symbols
- Illuminated or non-illuminated
- Optionally sealed to IP68

ELECTRICAL SPECIFICATIONS

- Current/voltage rating with resistive load :
 - Silver contacts (A) : 5A 24VDC, 100.000 cycles
10A 24VDC, 10.000 cycles (terminals 6.35 x 0.8 only)
 - Gold plated contacts (D) : 20mA 12V, 150.000 cycles
- Initial contact resistance : 10 mΩ max.
- Insulation resistance : 1.000 MΩ min. at 500VDC
- Dielectric strength : 2.000 Vrms 50 Hz min. between terminals
- Mechanical life : 150.000 cycles min.

MATERIALS

- Case : PA 6-6
- Actuator and unlocking actuator : ABS
- Bezel : PA 6-6
- Terminals : brass, silver plated
- Contacts : silver (A)
or silver, gold plated (D)
- Contact roller : brass, nickel plated

ENVIRONMENTAL SPECIFICATIONS

- Degree of protection of sealed versions : frontal sealing to IP68 according to IEC 60529 (submersion under 1 meter of water for more than 30 minutes)
- Salt spray resistance : 96 hours according to IEC 512-6, test 11f
- Operating temperature : -40°C to +85°C

SEALING

Sealing is optional.
To order a sealed product, complete the appropriate box of ordering format on the following pages.

DIMENSIONS

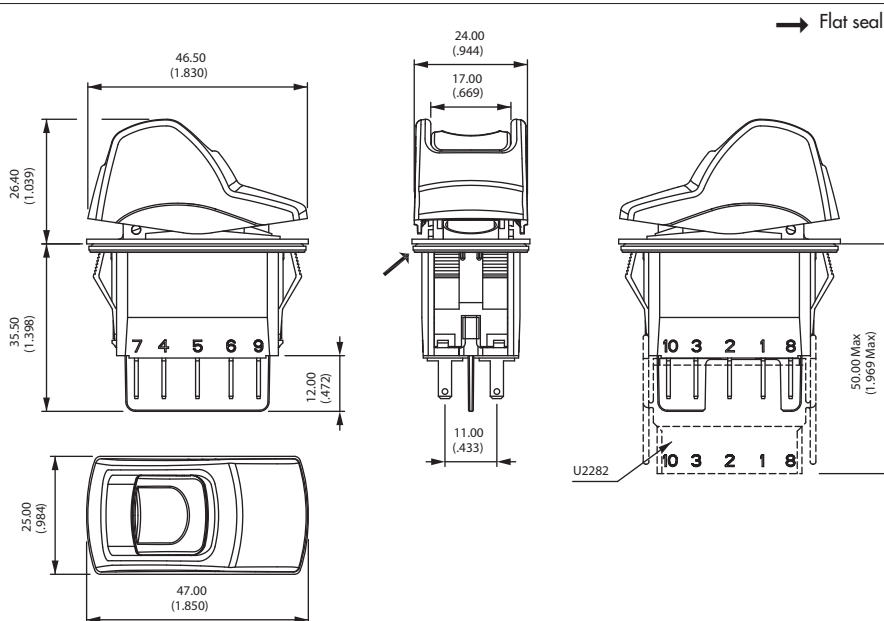

Packaging unit : 40 pieces

Dimensions : First dimensions are in mm while inches are shown as bracketed numbers.

KL series

Locking power rocker switches

Selection guide

- To order a complete product, fill in all the boxes of the following order guide.

CASE + LEDS

KL							Side B																																																																									
SERIES	Electrical functions			Contacts	Sealing	LEDS		Wiring																																																																								
Poles 3 Single pole 4 Double pole	<table border="1"> <tr><td>1</td><td>ON</td><td>-</td><td>OFF</td></tr> <tr><td>4</td><td>ON</td><td>ON</td><td>ON</td></tr> <tr><td>4-1R</td><td>ON</td><td>ON</td><td>MOM</td></tr> <tr><td>5</td><td>MOM</td><td>-</td><td>ON</td></tr> <tr><td>6</td><td>ON</td><td>-</td><td>ON</td></tr> <tr><td>7</td><td>MOM</td><td>OFF</td><td>MOM</td></tr> <tr><td>8</td><td>ON</td><td>OFF</td><td>MOM</td></tr> <tr><td>9</td><td>ON</td><td>OFF</td><td>ON</td></tr> </table> <p>Function 1 only for 6-terminal versions.</p> <p>Functions 5 and 6 cannot be combined with "H" wiring.</p>			1	ON	-	OFF	4	ON	ON	ON	4-1R	ON	ON	MOM	5	MOM	-	ON	6	ON	-	ON	7	MOM	OFF	MOM	8	ON	OFF	MOM	9	ON	OFF	ON	<table border="1"> <tr><td>A</td><td>Silver</td></tr> <tr><td>D</td><td>Gold plated</td></tr> </table>	A	Silver	D	Gold plated	<table border="1"> <tr><td>X</td><td>No</td></tr> <tr><td>K</td><td>Yes</td></tr> </table>	X	No	K	Yes	<table border="1"> <tr><td>X</td><td>None</td></tr> <tr><td>A</td><td>LED 6V red</td></tr> <tr><td>B</td><td>LED 6V green</td></tr> <tr><td>C</td><td>LED 6V yellow</td></tr> <tr><td>M</td><td>LED 6V blue</td></tr> <tr><td>R</td><td>LED 6V white</td></tr> <tr><td>D</td><td>LED 12V red</td></tr> <tr><td>E</td><td>LED 12V green</td></tr> <tr><td>F</td><td>LED 12V yellow</td></tr> <tr><td>N</td><td>LED 12V blue</td></tr> <tr><td>S</td><td>LED 12V white</td></tr> <tr><td>J</td><td>LED 24V red</td></tr> <tr><td>K</td><td>LED 24V green</td></tr> <tr><td>L</td><td>LED 24V yellow</td></tr> <tr><td>P</td><td>LED 24V blue</td></tr> <tr><td>T</td><td>LED 24V white</td></tr> </table>		X	None	A	LED 6V red	B	LED 6V green	C	LED 6V yellow	M	LED 6V blue	R	LED 6V white	D	LED 12V red	E	LED 12V green	F	LED 12V yellow	N	LED 12V blue	S	LED 12V white	J	LED 24V red	K	LED 24V green	L	LED 24V yellow	P	LED 24V blue	T	LED 24V white	See following pages.
1	ON	-	OFF																																																																													
4	ON	ON	ON																																																																													
4-1R	ON	ON	MOM																																																																													
5	MOM	-	ON																																																																													
6	ON	-	ON																																																																													
7	MOM	OFF	MOM																																																																													
8	ON	OFF	MOM																																																																													
9	ON	OFF	ON																																																																													
A	Silver																																																																															
D	Gold plated																																																																															
X	No																																																																															
K	Yes																																																																															
X	None																																																																															
A	LED 6V red																																																																															
B	LED 6V green																																																																															
C	LED 6V yellow																																																																															
M	LED 6V blue																																																																															
R	LED 6V white																																																																															
D	LED 12V red																																																																															
E	LED 12V green																																																																															
F	LED 12V yellow																																																																															
N	LED 12V blue																																																																															
S	LED 12V white																																																																															
J	LED 24V red																																																																															
K	LED 24V green																																																																															
L	LED 24V yellow																																																																															
P	LED 24V blue																																																																															
T	LED 24V white																																																																															
	Terminals			Terminals (continued)																																																																												
	Screw 0 6 terminals with barrier Solder lug/quick-connect 2 6 terminals with barrier 4 6 terminals w/o barrier A 10 term. with barrier B 10 term. w/o barrier C 10 terminals for use with connector U2292 Quick-connect 6,35x0,8 3 6 terminals with barrier			Quick-connect 6,35x0,8 5 6 terminals w/o barrier D 10 term. with barrier E 10 term. w/o barrier F 10 term. for use with connector U2292 Quick-connect 2,8x0,8 G 10 term. with barrier H 10 term. w/o barrier J 10 terminals for use with connector U2282																																																																												

ACTUATOR

Type	Rocker colour	Unlocking actuator colour
1 For non-illum. application 2 For illuminated application	1 Blue 1/4 Dark blue 2 Black 3 Green 4 Grey 5 Yellow 6 Red 7 Ivory 9 Orange	1 Blue 1/4 Dark blue 2 Black 3 Green 4 Grey 5 Yellow 6 Red 7 Ivory 9 Orange

ACTUATOR MARKING

	Area A	Area B	
Orientation	Symbols		Marking colour
			Illuminated models Blank White Non-illuminated 1 Blue 2 Black 3 Green 4 Grey 5 Yellow 6 Red 7 White 9 Orange

Symbols & Accessories : see end of section D.

NOTICE : please note that not all combinations of above numbers are available. Refer to the following pages for further information.

KL series

Locking power rocker switches

Case

MODEL
STRUCTURE

CASE + LEDS

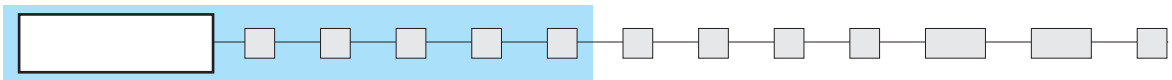

	2-3	5-6	1-2	4-5
Single pole KL31	ON	-	OFF	
Double pole KL41	ON	ON	ON	
KL44*	ON	ON	MOM	
KL44-1R*	MOM	-	ON	
KL35	ON	-	ON	
KL36	MOM	OFF	MOM	
KL37	ON	OFF	MOM	
KL38	ON	OFF	ON	
KL39	ON	OFF	ON	

* Function 4 : single pole in double pole case

Bottom view

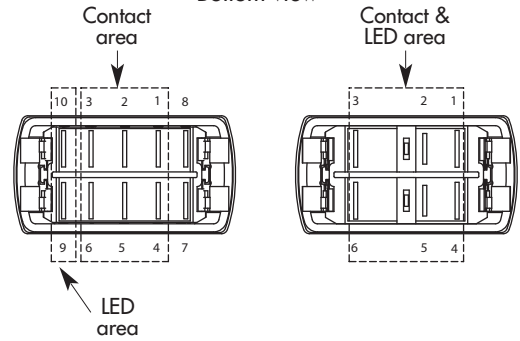

10 terminal version

6 terminal version

ELECTRICAL FUNCTIONS AND CONNECTIONS

In the tables below, terminal connections as viewed from bottom of switch. Only the contact area is represented. For single pole models, only terminals 1, 2 and 3 are to be considered (not 6, 5, 4).

x = w/o terminal
o = with terminal
▲ = momentary

	2 positions	
	Press unlocking actuator to unlock.	
Function 1 * KL31-KL41		
Function 5 KL35 - KL45		
Function 6 KL36-KL46		

	3 positions		
Function 7 KL37-KL47			
Function 8 KL38-KL48			
Function 9 KL39-KL49			
Function 4 KL44			
Function 4-1R KL44-1R			

*** Function 1**

- Only available for 6 terminal versions.
- Illuminated versions only available with "A" wiring.

KL series

Locking power rocker switches

Case

TERMINALS

CASE + LEDS

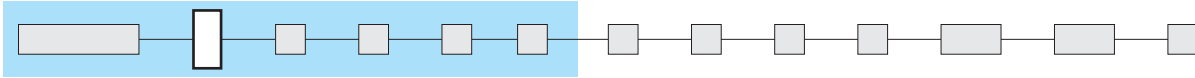

Screw

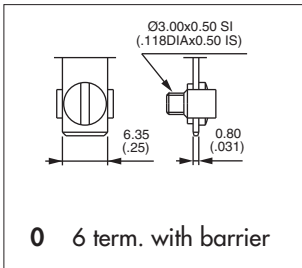

Solder lug / quick-connect

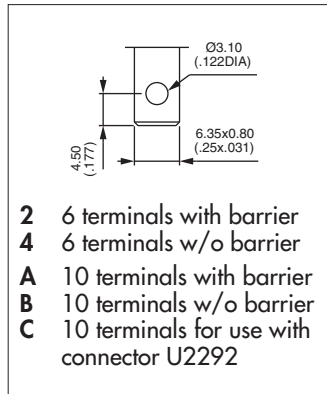

Normalized quick-connect 6,35x0,8

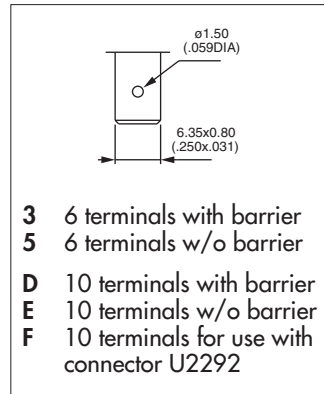

Normalized quick-connect 2,8x0,8

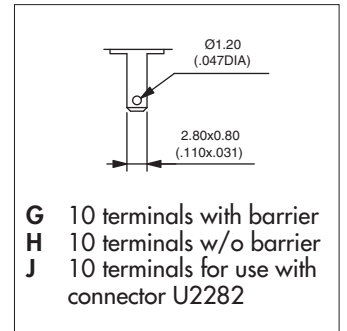

D

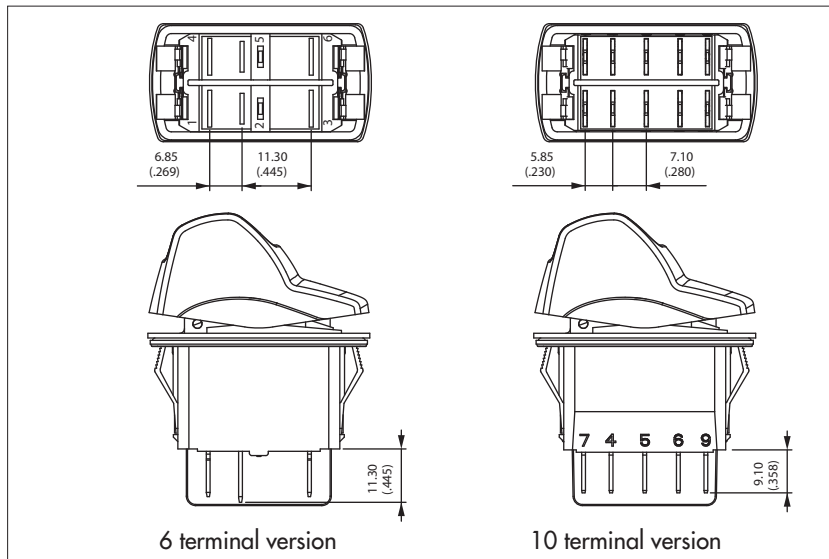

Terminals are marked on the case.

The drawings show the maximum possible number of terminals.

CONTACT MATERIALS

CASE + LEDS

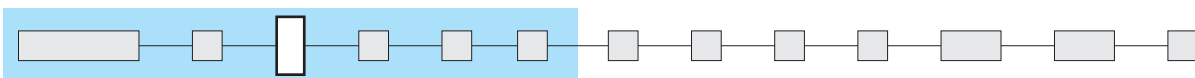

- A** Silver
- D** Silver, gold plated

KL series

Locking power rocker switches

Case - LEDs

SEALING

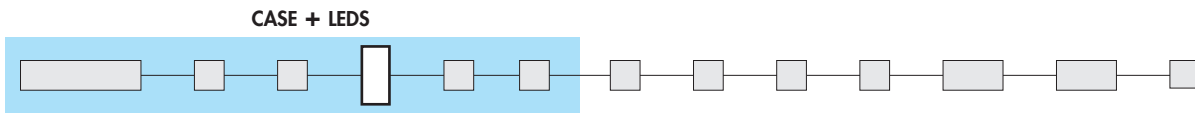

X No sealing

K IP68 (switch assembled on panel)

Ultrasonic welding of frame to case is standard on all versions.
The ultrasonic welding and the optional panel seal prevent water and dust from introducing into the switch housing.

*The product shall be installed professionally.
Test conditions available on request.*

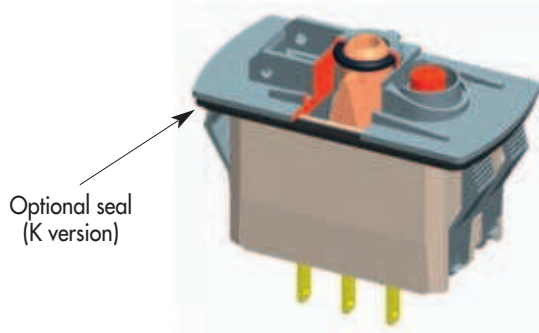

LEDS

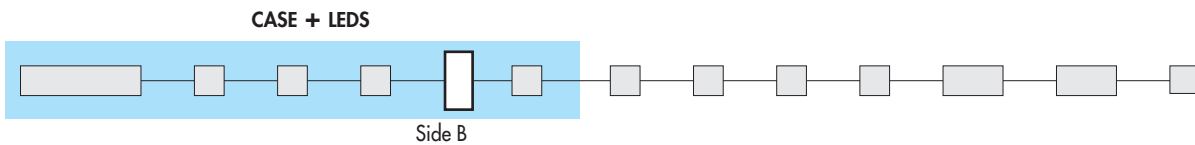

Complete enlarged box with one of the codes listed below.

X Without LED

	Red	Green	Yellow	Blue	White	Red/green
6VDC	A	B	C	M	R	1
12VDC	D	E	F	N	S	2
24VDC	J	K	L	P	T	3
No resistor	U	V	W	Y	Z	-

LED consumption : 20mA @ nominal voltage (25°C)
Other illumination solutions : on request.

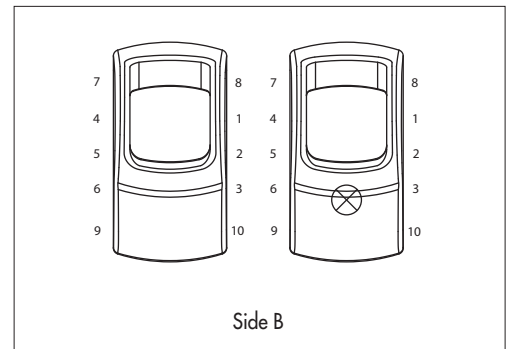

KL series

Locking power rocker switches

Case - LED

WIRING

The LED wiring diagram is shown on the case.

CASE + LED

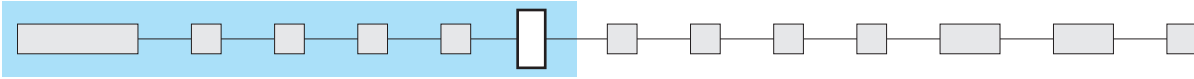

• For 6 terminal versions

LED connected to the load

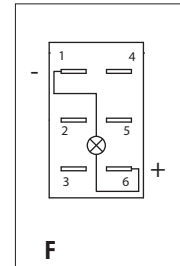
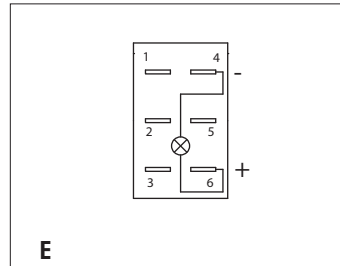
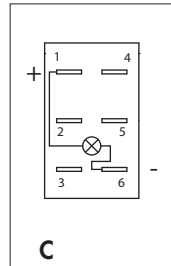
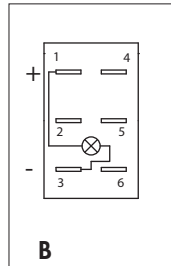
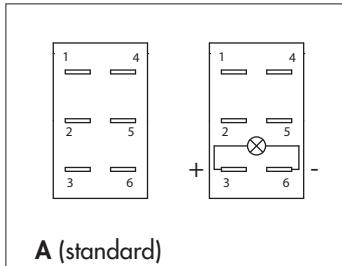

Note : If not available, terminals are added to connect the LED.

• For 10 terminal versions

Independent LED or integrated functions

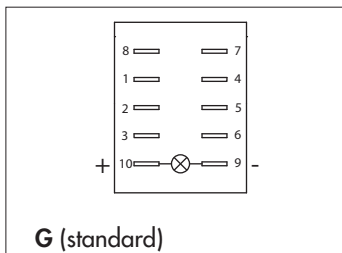

To have independent LED.

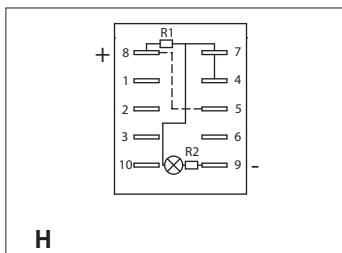

To obtain 2 symbol illumination levels (night illumination when OFF and higher illumination when ON).
Dotted line = external wiring, continuous line = internal wiring

Available in Single Pole only, with H and J quick-connect terminals.

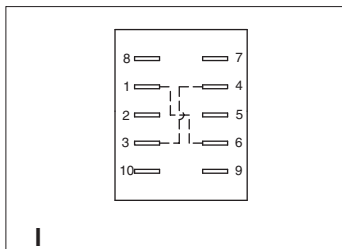

To have a polarity inversion (typical application : fan motor).
Dotted line = external wiring

Power supply between 2 and 5 - Load between 1 and 4 or 3 and 6.
Available with H and J quick-connect terminals.

Please contact us for other wiring solutions.

D

ACTUATOR TYPE

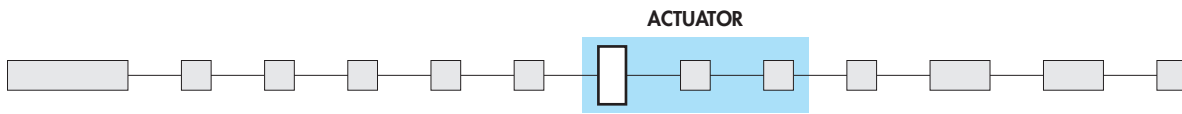

- 1 For non-illuminated application
- 2 For illuminated application

ROCKER COLOUR

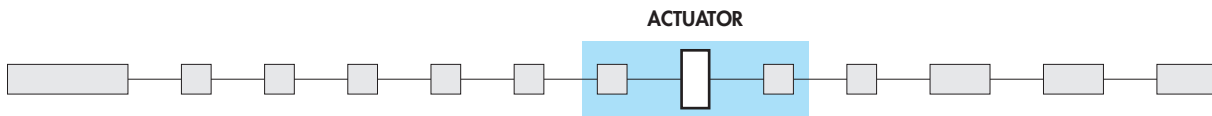

Code	Colour
1	Blue
1/4	Dark blue
2	Black

Code	Colour
3	Green
4	Grey
5	Yellow

Code	Colour
6	Red
7	Ivory
9	Orange

Note : colour 7 not available on illuminated versions

UNLOCKING ACTUATOR COLOUR

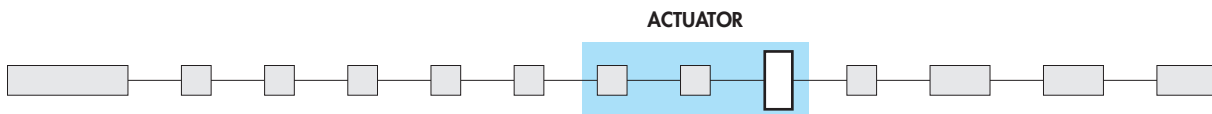

Code	Colour
1	Blue
1/4	Dark blue
2	Black

Code	Colour
3	Green
4	Grey
5	Yellow

Code	Colour
6	Red
7	Ivory
9	Orange

MARKING ORIENTATION

If no marking required, leave box blank.

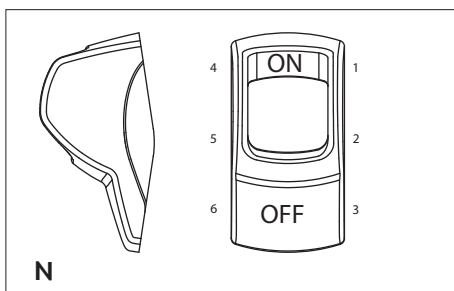
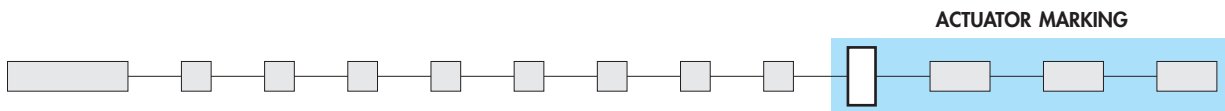

Other orientations : on request

KL series

Locking power rocker switches

Marking - Mounting

SYMBOLS

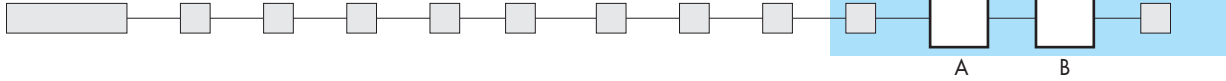

XX No symbol

Available symbols : see end of section D.

Laser etching resistance

- Water and petrol resistant according to EN61058-1
- Tear resistant (cross-cut test) according to NF ISO 2409 : class 0
- UV resistant according to ISO 4892-2

Marking area - The symbol will be included in the hatched area.

ACTUATOR MARKING

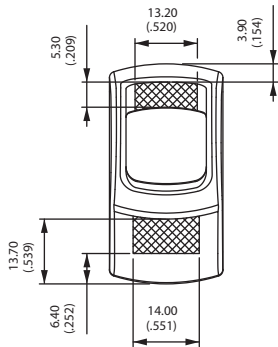
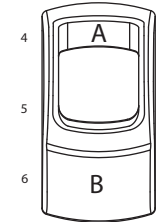
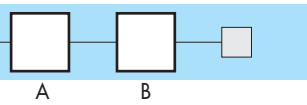

For illuminated versions

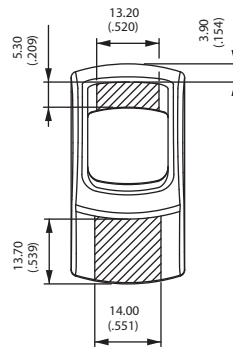

For non-illuminated versions

MARKING COLOUR

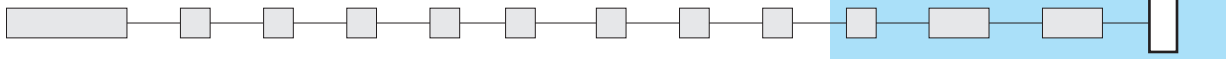

ACTUATOR MARKING

Illuminated models (laser etching)

Blank White

Non-illuminated models (pad printing)

1 : Blue - **2** : Black - **3** : Green - **4** : Grey - **5** : Yellow - **6** : Red - **7** : White - **9** : Orange

SWITCH PANEL CUT-OUT

Panel thickness : 0,8 mm to 4,6 mm

Recommended panel thickness :
between 2 mm and 3,5 mm

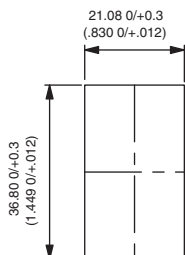

MATRIX MOUNTING

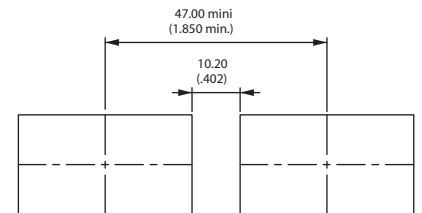
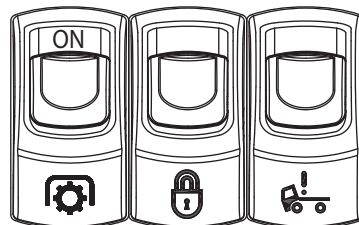
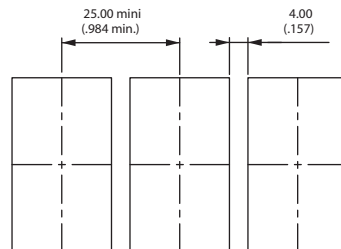

Most symbols meet the ISO 7000 standard "graphical symbols for use on equipments" (code given in bracket in the description). Contact us for symbols not featured in the following tables.

Legend scale :

KR series : 1:1

KL, KG and KI series : depending on space available on the product (see "Symbols" section at the end of each series).

CODE	SYMBOL	DESCRIPTION	CODE	SYMBOL	DESCRIPTION	CODE	SYMBOL	DESCRIPTION
XX	None	-	16		Revolving light	32		Emergency first aid vehicle (2565)
01	ON	-	17		Rear ventilator	33		Load tipping (1557)
02	OFF	-	18		Heating (0637)	34		Loading light (2457)
03	O	-	19		Door opening	35		Tractor, rear-ward (1667)
04	I	-	20		Windshield demister/defroster (0635)	36		Combine, direction of movement (1678)
05	II	-	21		Windshield wiper (0086)	37		Use no forks (2406)
06	STOP	-	22		Windshield washer (0088)	38		Transmission (1166)
07	A	Stop	23		Ventilator fan (0089)	39		Working spot light (1145)
08	M	Motion	24		Side mirror defroster	40		Engine (0640)
09		Up motion	25		Restarting pump	41		Horn (0244)
10		Down motion	26		Front fog lights (0633)	42		Lock (1656)
11		Hot	27		Rear fog lights (0634)	43		Taxi sign light (2551)
12		Cold	28		Propulsion system trim	44		Working light (1204)
13		Hazard warning (0085)	29		Beacon (1141)	45		Working light symmetric (1204)
14		Traveller lighting	30		Anchor	46		-
15		Driver lighting (1421)	31		Electric motor (0011)	47	ASM	-

K range

Power rocker switches and indicators









































Symbols

Most symbols meet the ISO 7000 standard "graphical symbols for use on equipments" (code given in bracket in the description). Contact us for symbols not featured in the following tables.

Legend scale :

KR series : 1:1

KL, KG and KI series : depending on space available on the product (see "Symbols" section at the end of each series).

CODE	SYMBOL	DESCRIPTION	CODE	SYMBOL	DESCRIPTION	CODE	SYMBOL	DESCRIPTION
48		All wheel drive	64		Indicator	80		Front windshield heating
49		Differential lock (1662)	65		Brake release	81	AUS	Aus
50		-	66		Baggage room left door	82		Radiator fan
51		-	67		Baggage room right door	83		Remove retarder
52		-	68		Power blinds	84		Restricted speed
53	N	-	69		Engine idle control	85		Preheater
54		Rear window wiper (0097)	70	CRUISE RES/SET	Cruise res/set	86		ABS detection
55		Rear window washer (0099)	71		Driver windows up/down	87		ECAS detection
56		Lower load (2223)	72		Middle door opening	88		Engine stop
57		Cab lock (1560)	73		Front door opening	89	CRUISE RES/CAN	Cruise res/cancel
58		Extraction	74		Lighting in baggage room	90		ECAS reset
59		Pumping in	75	CRUISE ON/OFF	Cruise on/off	91		Driver windows heating
60		Rear PTO (1572)	76	TV	TV	92	CRUISE SET+/SET-	Cruise set
61		Front PTO	77		Pump	93		Air bag up/down
62		Rockshaft down	78	WC	Toilet	94		Read lighting
63		Rockshaft up	79		Toilet decontamination	95		Lighting main switch

Most symbols meet the ISO 7000 standard "graphical symbols for use on equipments" (code given in bracket in the description). Contact us for symbols not featured in the following tables.

Legend scale :

KR series : 1:1

KL, KG and KI series : depending on space available on the product (see "Symbols" section at the end of each series).

CODE	SYMBOL	DESCRIPTION	CODE	SYMBOL	DESCRIPTION	CODE	SYMBOL	DESCRIPTION
96		Heating using water	AD		-	AV		-
97		Low beam	AE		-	AW		-
98		Position lights	AF		-	AY		-
99		Diesel acceleration	AG		Battery charging condition (0247)	AZ		-
A1		Manual mode	AH		Turn signals (0084)	B1	HIGH	-
A2		Clockwise cabin rotation	AJ		High beam (0082)	B2	LOW	-
A3		Anticlockwise cabin rotation	AK		Differential lock, bogie (2600)	B3		-
A4		-	AL		Brushing with a rotating brush (0070)			
A5		-	AM		Differential lock, transfer case 4x4 (2475)			
A6		Parking brake	AN		Loader bucket, float (1441)			
A7		-	AP		Loader bucket (1437)			
A8		-	AQ		Rear window washer & wiper (0098)			
A9		-	AR		Header Header drive (1579)			
AA		-	AS		Excavator/backhoe boom side shift (2091)			
AB		-	AT		Chemical water treatment (1851)			
AC		-	AU		Grapple skidder, single funct° boom (1762)			

K range

Power rocker switches and indicators

Accessories for KR, KL and KI series

MOUNTING PANEL END

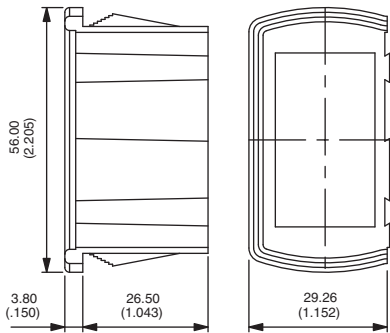

U2261

MOUNTING PANEL MIDDLE

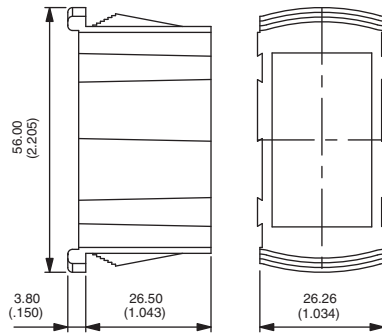

U2262

SINGLE MOUNTING PANEL

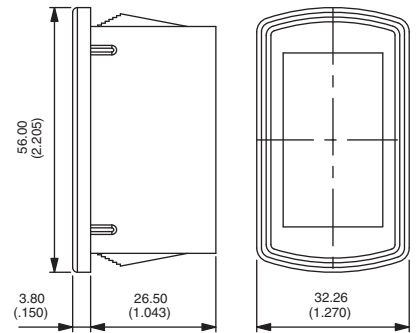

U2267

Recommended panel thickness : 1,10 mm - 1,80 mm - 2,60 mm - 3,40 mm - 4,20 mm - 5 mm - 5,80 mm

MOUNTING PANEL CUT-OUT

For additional elements, add 26,40 mm (1.039)

For 1 element U2267

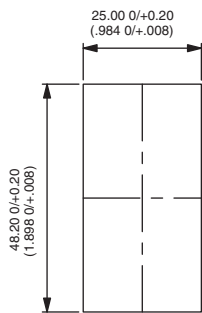

For 2 elements U2261

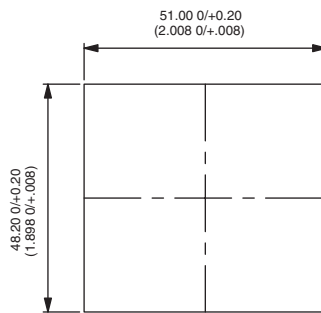

For 3 elements (2xU2261 + 1x U2262)

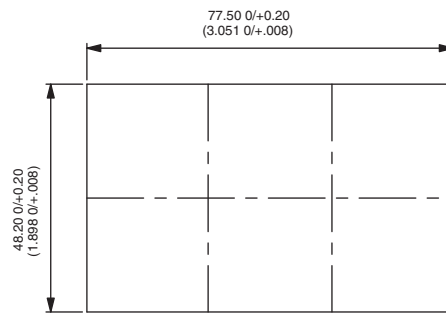

22 x 44 ADAPTER

Front panel dismounting

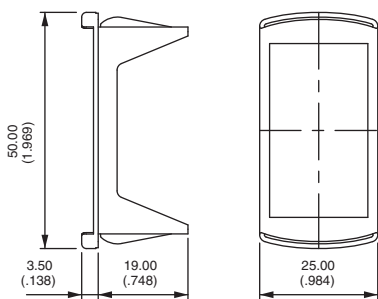

U3060

22 x 44 ADAPTER

Rear panel dismounting

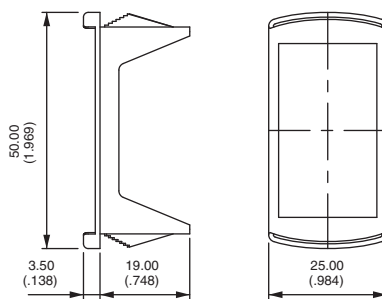

U3070

PANEL CUT-OUT

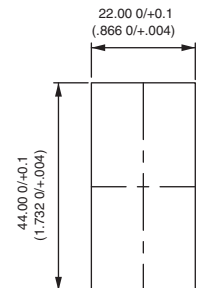

Adapter colours (replace 0 with code)
 1/4 : dark blue - 2 : black - 4 : grey
 5 : yellow - 6 : red - 7/1 : white

Recommended panel thickness : 0,60 mm to 1,50 mm

Recommended panel thickness : 1,60 mm -0,1/0 to 5,60 mm -0,1/0 in stages of 0,40 mm

ACTUATOR REMOVING TOOL



U3052

2 tools are supplied

EXTRACT ACTUATOR (KR ONLY)

Allows the extraction of the rocker / rocker support assembly.
Place the 2 claws under the support and push as indicated by the arrow.

EXTRACT ROCKER (KR ONLY)

Allows to separate the rocker from its support.

Insert the tool between rocker and support as indicated by the arrow. Pull out the tool in the opposite direction.

EXTRACT SWITCH (KR, KL AND KI)

Allows to extract switch from panel mounting units. 2 tools are necessary.

Insert the tools between switch and panel mounting units from the rear to compress the snap-in device. Pull off switch manually.

CONNECTORS

Standard colour : black. Other colours : on request.

Connectors cannot be combined with wiring types H and I.



U2260

6 terminal version

For use with terminals type 2, 3, 4 or 5.
6,35 (1/4) tabs to be fitted by the user
(example : AMP/Tyco 0-0141013-2).
Can be used for the KG series.



U2282

10 terminal version

For use with terminals type H or J.
2,8 (.110) tabs to be fitted by the user
(example : AMP/Tyco 0-927779-3).



U2292

10 terminal version

For use with terminals type B, C, E or F.
6,35 (1/4) tabs to be fitted by the user
(example : AMP/Tyco 0-0141013-2).

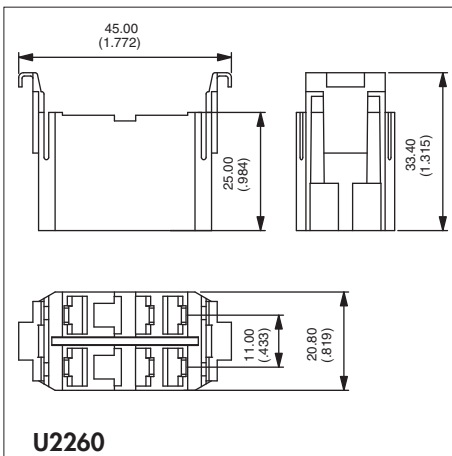

U2260

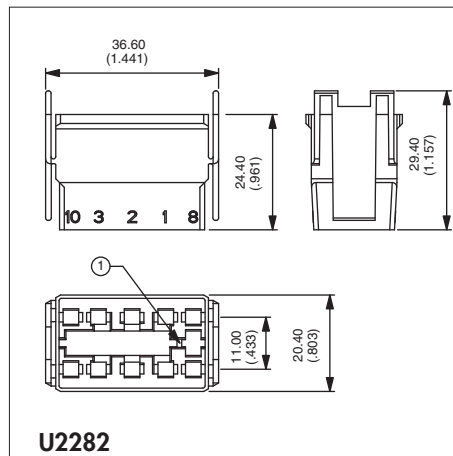

U2282

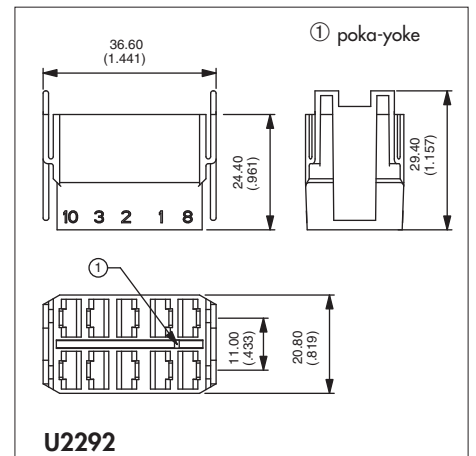

U2292

K range

Power rocker switches and indicators

Accessories for KR, KL and KI series

HOLE PLUGS

Usefull for future extensions.

Code	Colour	Code	Colour
U2271	Blue	U2274	Grey
U2271/4	Dark blue	U2275	Yellow
U2272	Black	U2276	Red
U2273	Green	U2277	Ivory
		U2279	Orange

Recommended panel thickness :
1,50 mm to 6 mm

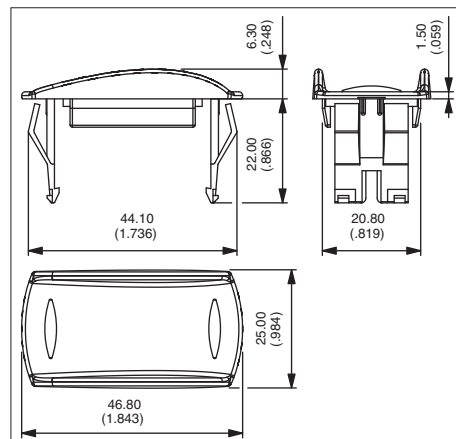

Connectors can be hanged on specific hole plugs. Contact APEM.

D