

LPI series

Tactile pushbutton switches with large actuator

Distinctive features and applications



❑ Common features

- Large ergonomic actuator (Ø 35 mm)
- Tactile feedback
- Low behind-panel depth (21 mm max.)
- Stylish design
- Long life

This series has been developed on a modular base in order to fit the exact needs of technicians and end-users.

❑ Installation options

The LPI series has a number of features to ensure easy installation:

- Front or rear mounting
- With or without sealing
- 2 separate circuits for NO/NC 5A version
- Terminal block connector for 0,1A NO version
- 3 different LED voltages: 6V, 12V, 24V
- Integrated LED resistor

❑ Aesthetic options

- Ring or dot illumination
- Wide range of LED colours
- Wide range of bezel colours
- Many different actuator types and colours

❑ Applications

Because of its large actuator, this product is suited to all indoor applications where the pushbutton needs to be located quickly (access control, call information, museums, exhibitions). This product is also ideal for applications where the end-user uses gloves.

This product meets the requirements of EN81-70 and is ideal for use in all types of indoor lifts.

LPI series

Tactile pushbutton switches with large actuator

Overview

SWITCH BLOCK

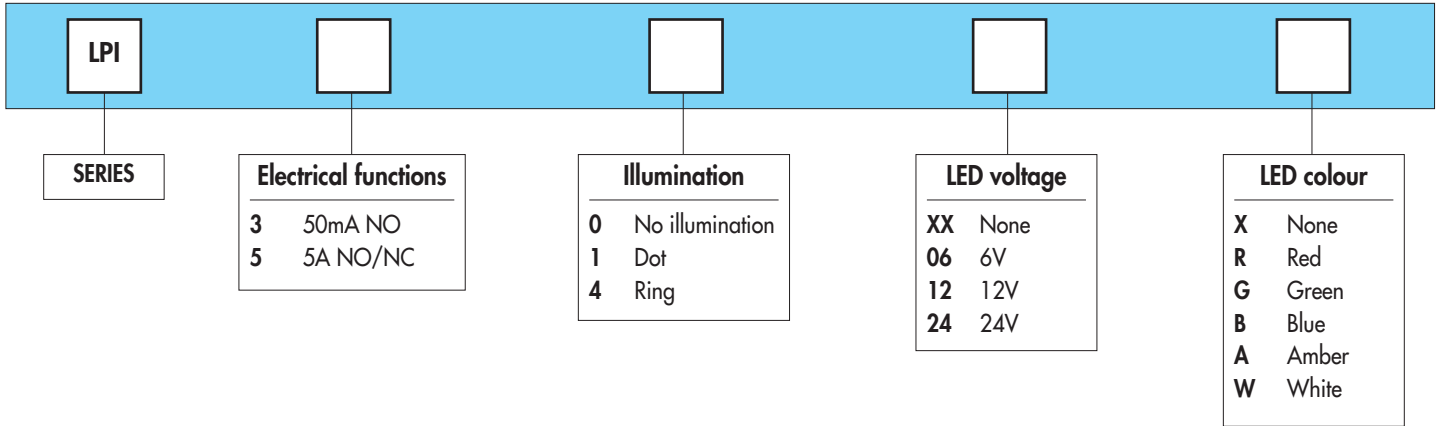

OPERATOR

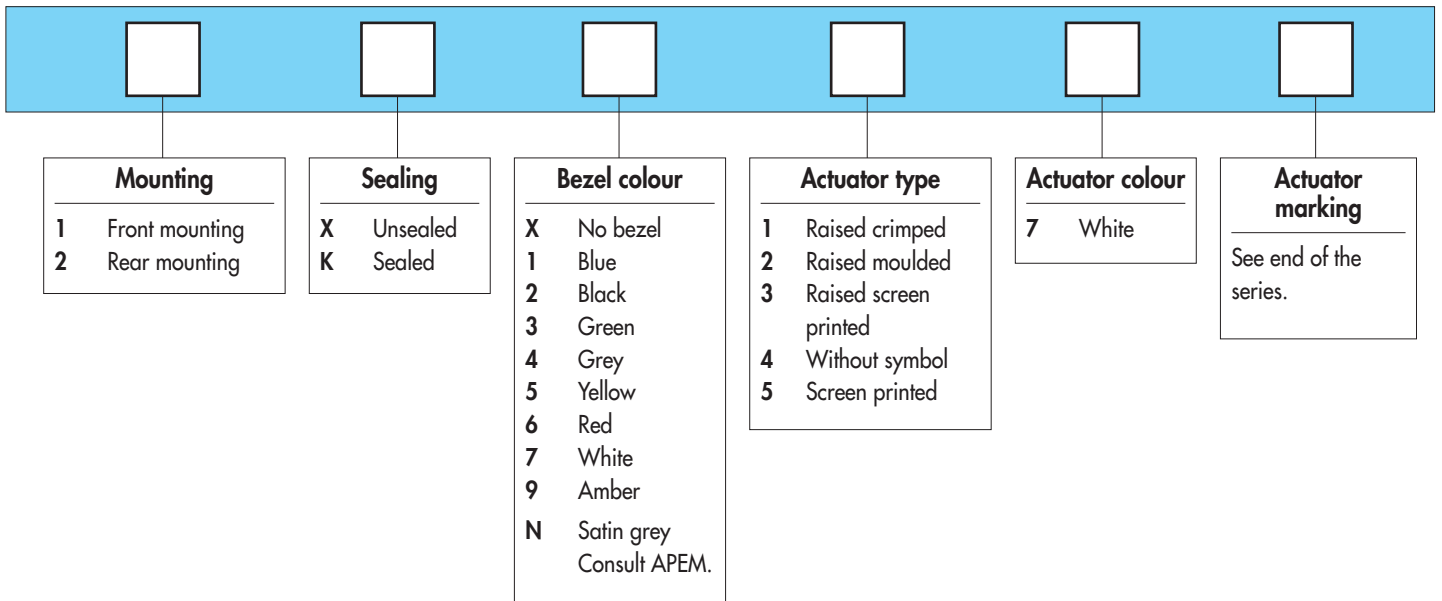

ABOUT THIS SERIES

On the following pages, you will find successively switch block order numbers and operator order numbers.

Dimensions : first dimensions are in m while inches are shown as bracketed numbers.



NOTICE : please note that not all combinations of above numbers are available. Refer to the following pages for further information.



Packaging unit : 15 pieces for front mounting versions - 20 pieces for rear mounting versions.



Sealing boot available to increase the sealing of LPI switches. See section H.

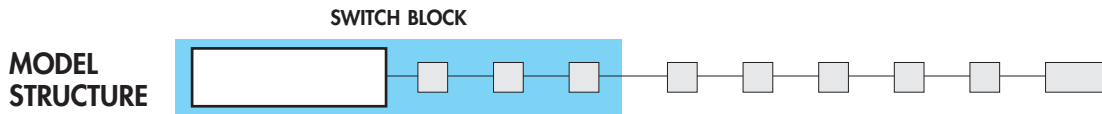

5A momentary NC/NO combined



LPI5

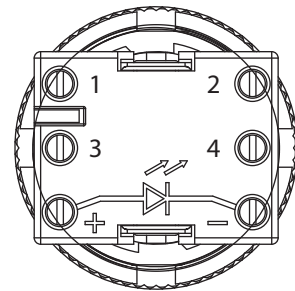
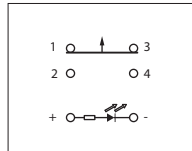

Terminal block

Wire size : AWG20-15 - 0,5 to 1,5 mm²
 Rated torque : 0,5 Nm
 Screw size : M3

50mA momentary NO



LPI3

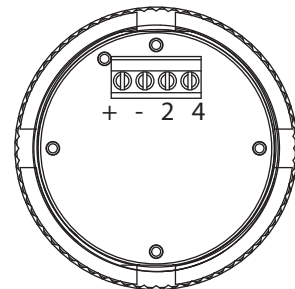
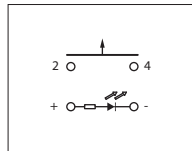

Terminal block

Wire size : AWG28-16 - 0,5 to 1 mm²
 Rated torque : 0,4 Nm
 Screw size : M2

LPI series

Tactile pushbutton switches with large actuator

Switch block

ILLUMINATION

SWITCH BLOCK

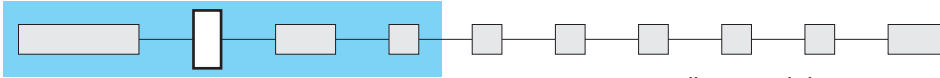

- 0 Non-illuminated
- 1 Illuminated dot (1 LED)
- 4 Illuminated ring (4 LEDs)

Option 4 available only in the case of screen-printed symbol

Illuminated dot



Option 1

Illuminated ring



Option 4

LED VOLTAGE

SWITCH BLOCK

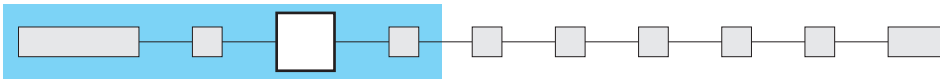

- XX Non-illuminated
- 06 6V
- 12 12V
- 24 24V



Combination with other options : see table below.

- Integrated resistors
- LED current : 20mA typical for dot or ring (30mA max.)
- LEDs protected from reverse polarity
- Stand-by consumption for illuminated product : 0,5VA max.

LED COLOUR

SWITCH BLOCK

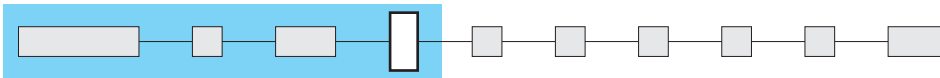

- X Non-illuminated
- R Red
- G Green
- A Amber
- B Blue
- W White

Colours available with illuminated ring (option 4)

	Red	Green	Amber	Blue	White
LED voltage	Version 5A				
6V	No	No	No	No	No
12V	Yes	Yes	No	No	No
24V	Yes	Yes	Yes	Yes	Yes
LED voltage	Version 50mA				
6V	No	No	No	No	No
12V	Yes	No	Yes	No	No
24V	Yes	Yes	Yes	Yes	Yes@

MOUNTING

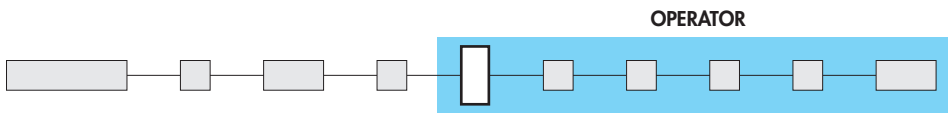

- 1 Front mounting
- 2 Rear mounting

FRONT MOUNTING - 50mA version

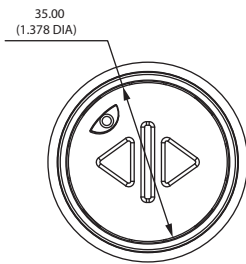
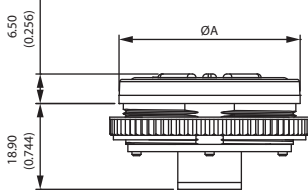

FRONT MOUNTING - 5A version

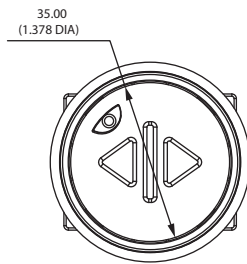
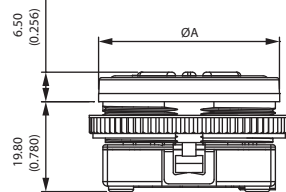

REAR MOUNTING - all versions

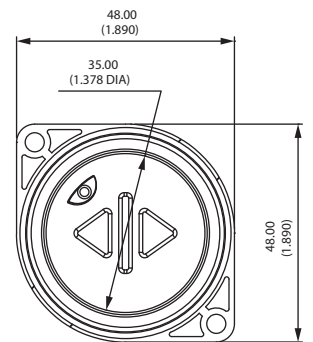
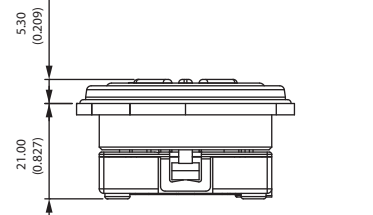

MATRIX MOUNTING

All versions

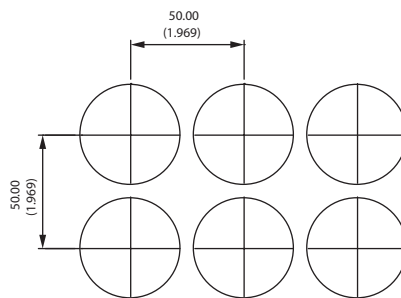

Dimension A

Sealed models : 44 mm (1.732)

Unsealed models : 39,9 mm (1.570)

SEALING

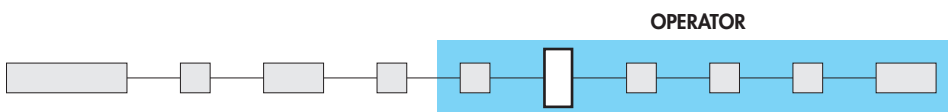

- X Unsealed
- K Sealed

Note : bezel compulsory on sealed versions.

LPI series

Tactile pushbutton switches with large actuator

Operator

BEZEL COLOUR

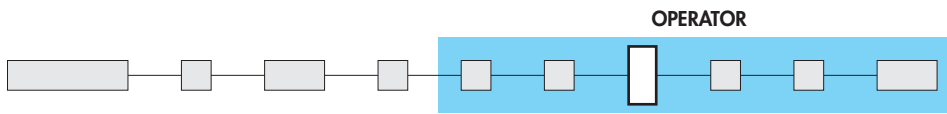

- X No bezel
- 1 Blue
- 2 Black
- 3 Green
- 4 Grey
- 5 Yellow
- 6 Red
- 7/1 White
- 9 Orange



Satin grey (option N) : consult APEM.

For sealed versions, the bezel is compulsory.

ACTUATOR TYPE

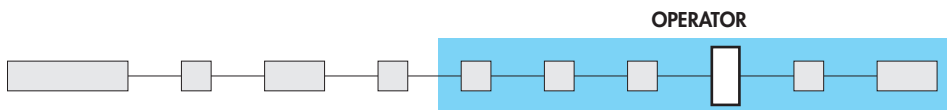

- 1 Stainless steel raised crimped symbol
- 2 Raised moulded symbol (star and bell)
- 3 Raised screen printed symbol
- 4 Without symbol
- 5 Screen printed symbol

Ring illumination available with options 3, 4 and 5 only.

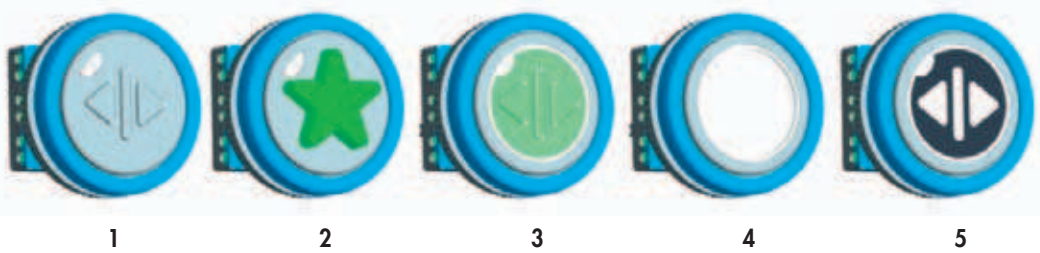

ACTUATOR COLOR

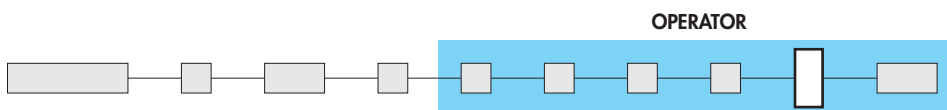

- 7 White



ACTUATOR MARKING

OPERATOR

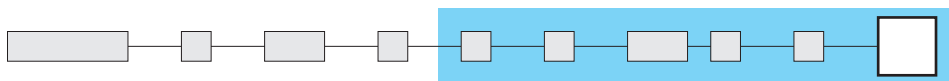

CODE	SYMBOL	DESCRIPTION
XX	/	No symbol
00	0	
01	1	
02	2	
03	3	
04	4	
05	5•	With single tactile point
06	6	
07	7	
08	8	
09	9	
11	-1	
12	-2	
13	-3	

CODE	SYMBOL	DESCRIPTION
14	◀▶	Open
15	▶◀	Close
16	△	Up
17	▽	Down
18	◁	Left
19	▷	Right
20	☼	Ventilation
21	🔔	Alarm (moulded, yellow)
22	★	Exit level (moulded, green)
23	☎	Phone

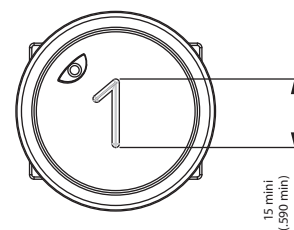
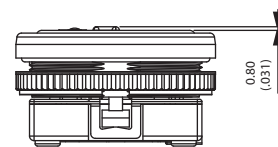

Actuator type 1

	Symbol height		
	Symbol 21	Symbol 22	Other symbol
Actuator type 1	x	x	0,8 mm
Actuator type 2	0,8 mm	5 mm	x
Actuator type 3	x	x	0,8 mm
Actuator type 4	x	x	x
Actuator type 5	x	x	0 mm

x = non available