

DO NOT SCALE FROM THIS PRINT

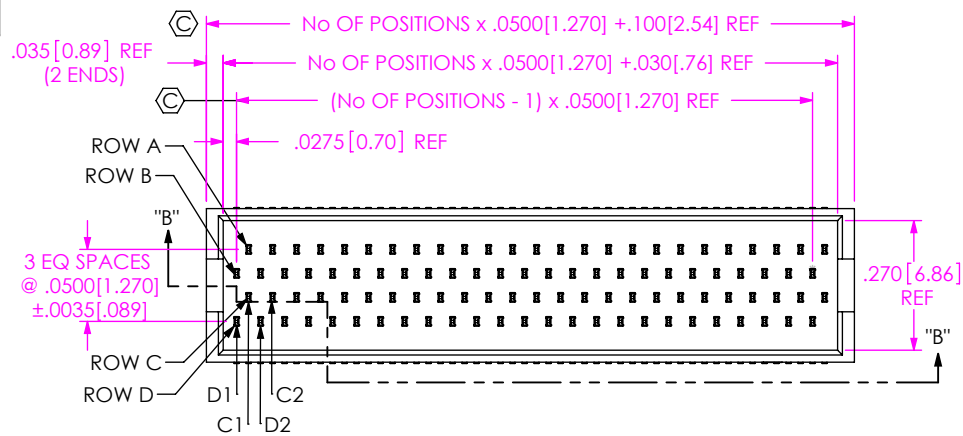

TOLC-1XX-XX-X-Q-XX

No OF POSITIONS
 -05, -10, -15, -20, -25
 -30, -35, -40, -45, -50
 (PER ROW)

LEAD STYLE
 (SEE TABLE T)
 -02, -12, -22, -32

PLATING SPEC
 (VALUES GIVEN ARE
 IN MICRO-INCHES)

-S: SELECTIVE, 30 Au / 50 Ni MIN ON CONTACT, 3 Au / 50 Ni MIN ON TAIL
 -L: LIGHT SELECTIVE, 10 Au / 50 Ni MIN ON CONTACT, 3 Au / 50 Ni MIN ON TAIL
 -F: FLASH GOLD, 3 Au / 50 Ni MIN ON CONTACT, 3 Au / 50 Ni MIN ON TAIL

OPTIONS
 -LC: LOCKING CLIP (SEE NOTE 5)
 (USE LC-09-TM)
 (NOT AVAILABLE WITH -A)
 -P: PICK & PLACE PAD
 (EXISTING CUSTOMER SUPPORT ONLY)
 (USE ASP-90590-01-S)
 -TR: TAPE & REEL
 -A: ALIGNMENT PIN
 (USE TOLC-XX-Q-A FOR STYLE -02 AND
 TOLCH-XX-Q-A FOR STYLES -12, -22
 & -32)
 (NOT AVAILABLE WITH -LC)
 -PL: PLASTIC PICK & PLACE PAD
 (USE ASP-90590-01-S)
 -K: POLYIMIDE FILM PAD
 (.005[.13] THICK W SILICON ADHESIVE)
 (USE K-850-650)
 ROW SPEC
 -Q: QUAD
 (USE TOLC-XX-Q)

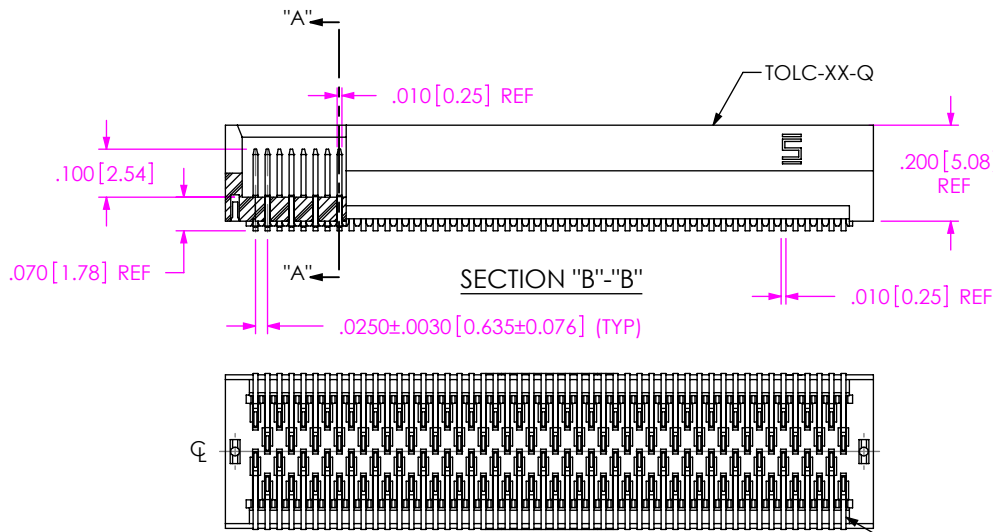
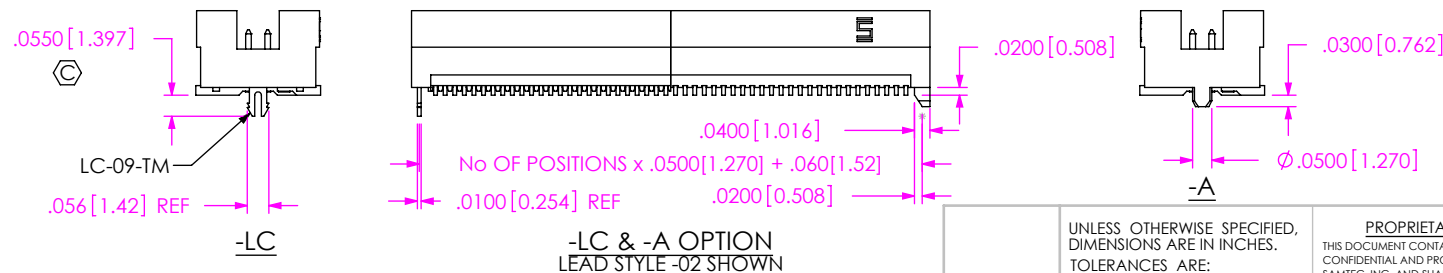

FIG 1



| LEAD STYLE | "A" | USE TERMINAL | SEE FIG | BOARD SPACE WHEN MATED WITH SOLC |
|------------|---------------|-----------------|---------|----------------------------------|
| -02 | .2200[5.588] | T-1M13-01-XXX-2 | 1 | .2500[6.350] |
| -12 | .2850[7.239] | T-1M14-02-XXX-2 | 2 | .3150[8.000] |
| -22 | .3637[9.238] | T-1M14-03-XXX-2 | 2 | .3937[10.000] |
| -32 | .4424[11.237] | T-1M14-04-XXX-2 | 2 | .4724[12.000] |

NOTES:
 1. MINIMUM PUSHOUT FORCE: .5 LB.
 2. PARTS TO BE PACKAGED IN TUBES.
 3. -S PLATING CAN BE SUBSTITUTED FOR -L AND -F PLATING STYLES.
 4. © REPRESENTS A CRITICAL DIMENSION.
 5. DUE TO THE HIGH AMOUNT OF INSERTION FORCE NEEDED, THE -LC OPTION IS NOT COMPATIBLE WITH AUTO PLACEMENT. SAMTEC RECOMMENDS MANUAL PLACEMENT FOR ALL ASSEMBLIES WITH THE -LC OPTION.

UNLESS OTHERWISE SPECIFIED, DIMENSIONS ARE IN INCHES. TOLERANCES ARE:
 DECIMALS .XX: ±.01[.3] ANGLES .XXX: ±.005[.13] ±5° .XXXX: ±.0020[.051]

PROPRIETARY NOTE
 THIS DOCUMENT CONTAINS INFORMATION CONFIDENTIAL AND PROPRIETARY TO SAMTEC, INC. AND SHALL NOT BE REPRODUCED OR TRANSFERRED TO OTHER DOCUMENTS OR DISCLOSED TO OTHERS OR USED FOR ANY PURPOSE OTHER THAN THAT WHICH IT WAS OBTAINED WITHOUT THE EXPRESSED WRITTEN CONSENT OF SAMTEC, INC.



520 PARK EAST BLVD, NEW ALBANY, IN 47150
 PHONE: 812-944-6733 FAX: 812-948-5047
 e-Mail info@SAMTEC.com code 55322

MATERIAL: DO NOT SCALE DRAWING SHEET SCALE: 1:0.4
 BODY: LCP UL 94 VO, COLOR: BLACK
 TERMINAL: PHOSPHOR BRONZE
 c:\enterprise\aut\DWG\MISC\MKTG\TOLC-1XX-XX-X-Q-XX-MKT.SLDDRW

DESCRIPTION: QUAD ROW STAGGERED SMT TERMINAL ASM
 DWG. NO. TOLC-1XX-XX-X-Q-XX
 BY:D PURVIS 03/18/1996 SHEET 1 OF 2

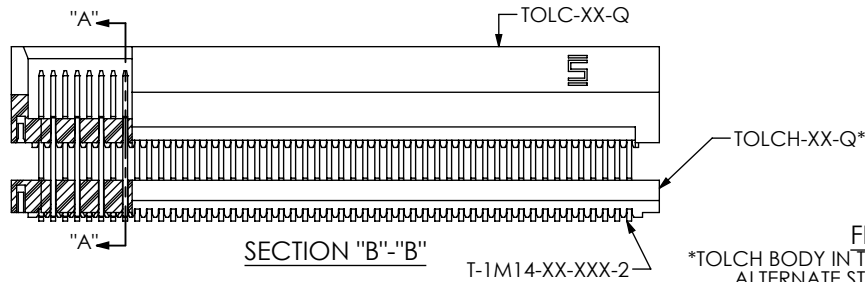
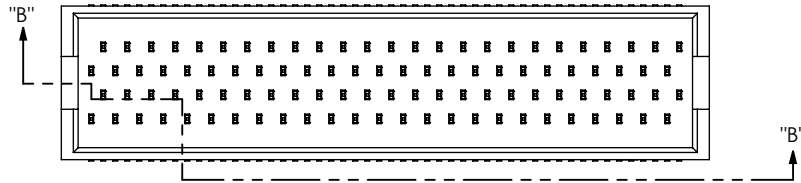
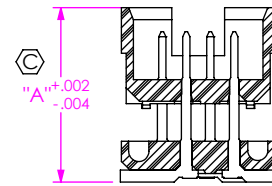
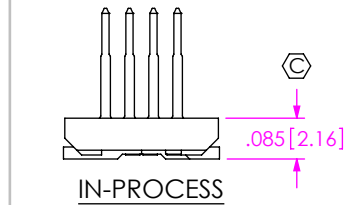

FIG 2
*TOLCH BODY IN THIS DESIGN REFLECTS ALTERNATE STANDOFF DESIGN



SECTION "A"- "A"



| | | |
|--|--------------|------------------|
| | .0040 [1.02] | -05 THRU -30 POS |
| | .0060 [1.52] | -35 THRU -50 POS |

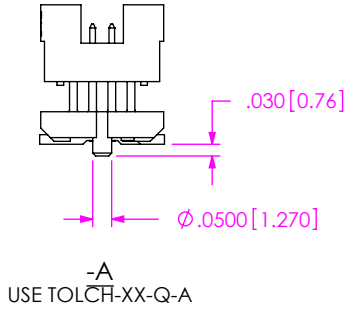
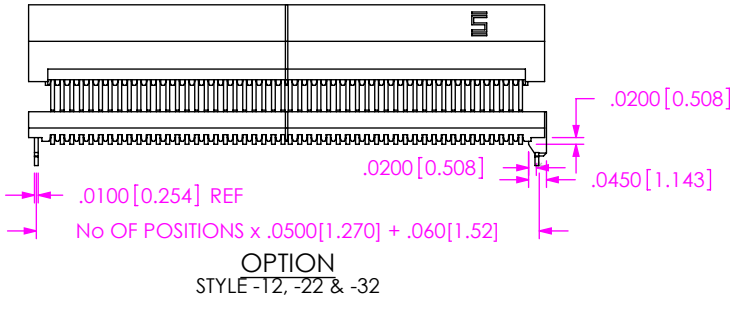
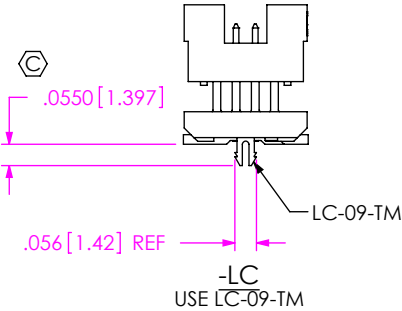
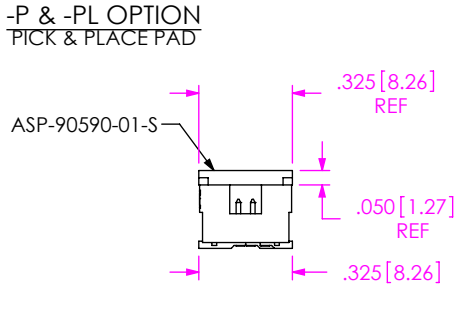
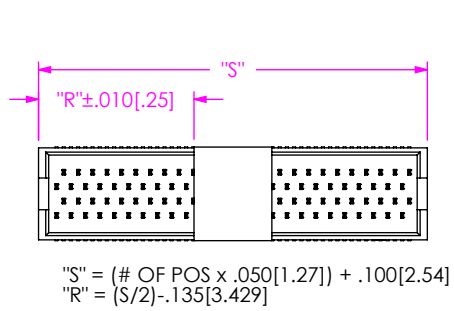
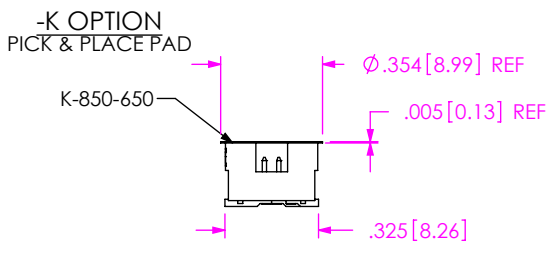
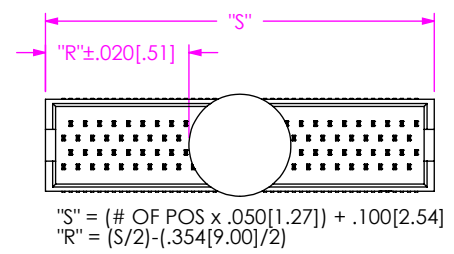
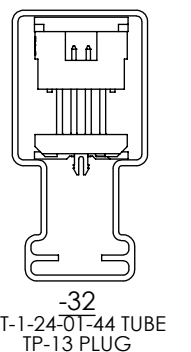
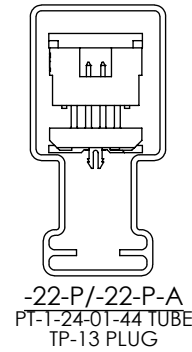
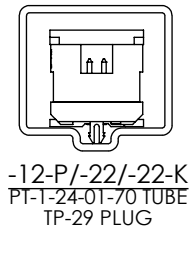
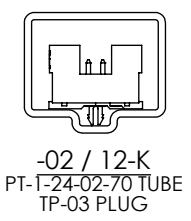

TABLE 2

| LEAD STYLE | OPTIONS | PACKAGING TUBE | PLUG |
|------------|-------------------|----------------|-------|
| -02 | ALL | PT-1-24-02-70 | TP-03 |
| -12 | -P | PT-1-24-01-70 | TP-29 |
| -12 | NONE, -K, -A | PT-1-24-02-70 | TP-03 |
| -22 | -P, -P-A | PT-1-24-01-44 | TP-13 |
| -22 | NONE, -K, -A, -LC | PT-1-24-01-70 | TP-29 |
| -32 | ALL | PT-1-24-01-44 | TP-13 |



PACKAGING VIEWS



PROPRIETARY NOTE
THIS DOCUMENT CONTAINS INFORMATION CONFIDENTIAL AND PROPRIETARY TO SAMTEC, INC. AND SHALL NOT BE REPRODUCED OR TRANSFERRED TO OTHER DOCUMENTS OR DISCLOSED TO OTHERS OR USED FOR ANY PURPOSE OTHER THAN THAT WHICH IT WAS OBTAINED WITHOUT THE EXPRESSED WRITTEN CONSENT OF SAMTEC, INC.

SHEET SCALE: 1:0.4



520 PARK EAST BLVD., NEW ALBANY, IN 47150
PHONE: 812-944-6733 FAX: 812-948-5047
e-Mail info@SAMTEC.com code 55322

DESCRIPTION:
QUAD ROW STAGGERED SMT TERMINAL ASM
DWG. NO. TOLC-1XX-XX-X-Q-XX