

# DESIGNED & DIMENSIONED IN MILLIMETERS (INCHES FOR REFERENCE)

LSS-1XX-XX-XX-DV-XX-XX

DO NOT  
SCALE FROM  
THIS PRINT

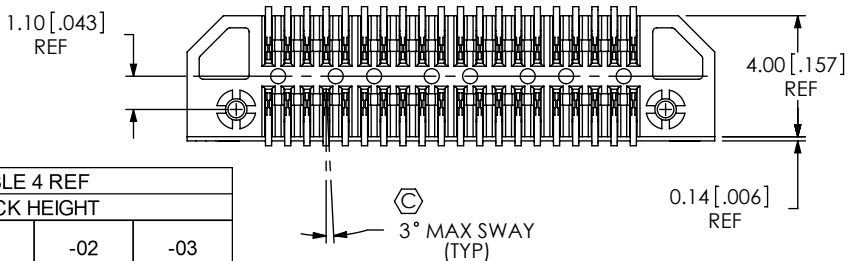
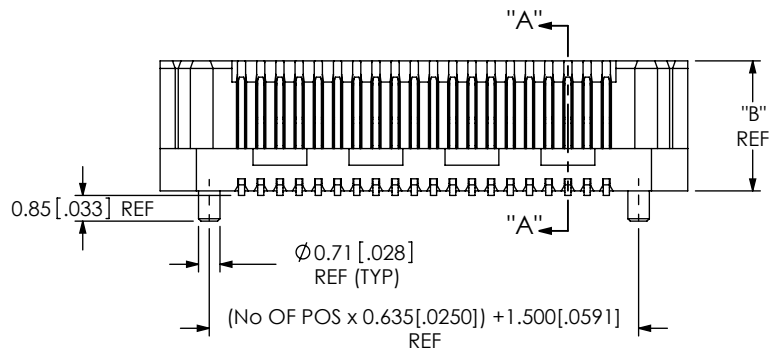
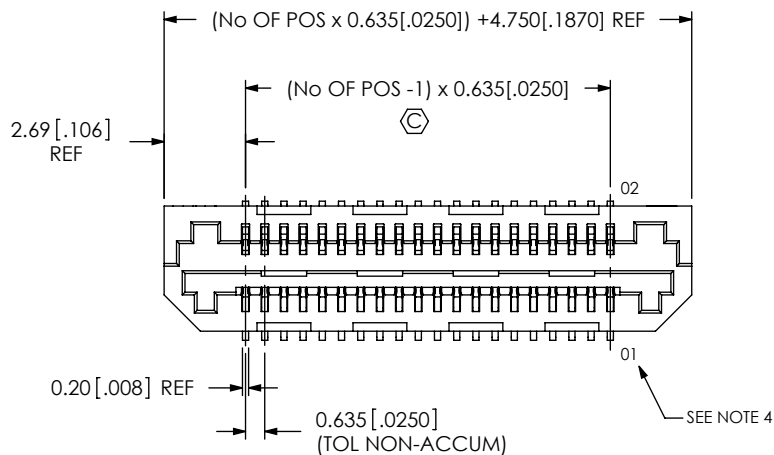

FIG 1  
LSS-120-01-XX-DV-A SHOWN

NO OF POSITIONS  
-05, -10, 20, -30, -40, -50  
(PER ROW)

LEAD STYLE  
-01: 3 mm (SEE TABLE 3)  
-02: 6 mm (SEE TABLE 3)  
-03: 4 mm (SEE TABLE 3)

PLATING SPECIFICATION  
-L: 10µ" GOLD IN CONTACT AREA,  
MATTE TIN ON TAIL  
(USE C-185-XX-LM)  
-F: 3µ" GOLD IN CONTACT AREA,  
MATTE TIN ON TAIL  
(USE C-185-XX-FM)  
\* -LM: 10µ" GOLD IN CONTACT AREA,  
MATTE TIN ON TAIL  
(USE C-185-XX-LM)  
\* -FM: 3µ" GOLD IN CONTACT AREA,  
MATTE TIN ON TAIL  
(USE C-185-XX-FM)

OPTION  
-K: POLYIMIDE FILM  
(USE K-DOT-.138-.250-.005)  
(SEE FIG 2, SHT 2)  
-TR: TAPE & REEL  
(SEE FIG 4, SHT 2)

OPTION  
-A: ALIGNMENT PIN  
(REQUIRED FOR -01 LEAD STYLE;  
OPTIONAL FOR -02 & -03)  
-LC: LOCKING CLIP  
(-02 & -03 LEAD STYLES ONLY)  
(USE LC-08-TM-01)  
(SEE FIG 3, SHT 2)  
(SEE NOTE 6)

ROW SPECIFICATION  
-DV: DOUBLE VERTICAL

\* = FOR EXISTING CUSTOMERS ONLY

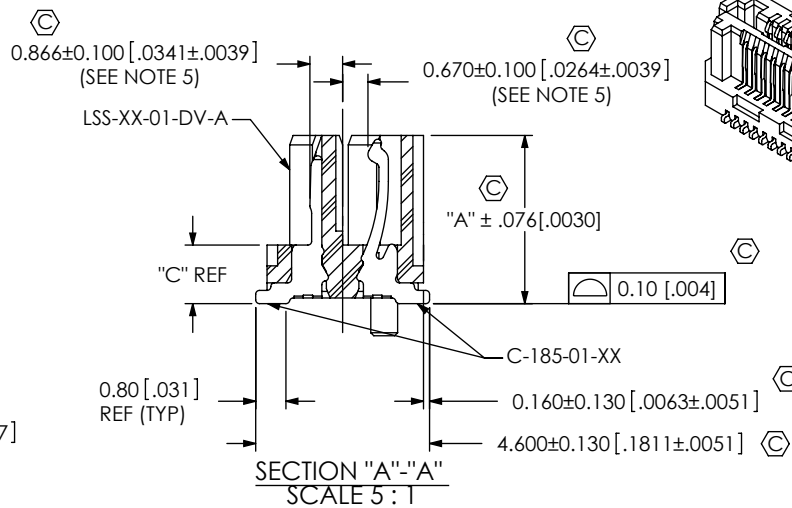

SECTION "A"-A"  
SCALE 5:1

TABLE 4 REF STACK HEIGHT			
LSS LEAD STYLE	-01	-02	-03
-01	6.0MM		
-02	9.0MM	12.0MM	
-03	7.0MM	10.0MM	8.0MM

TABLE 1			
BODY HT	"A"	"B"	"C"
-01	4.496 [.1770]	4.300 [.1693]	1.596 [.0628]
-02	7.493 [.2950]	7.300 [.2874]	4.593 [.1808]
-03	5.493 [.2163]	5.300 [.2087]	2.593 [.1021]

TABLE 3		
LEADSTYLE	BODY	PIN
-01	LSS-XX-01-DV-A	C-185-01-X
-02	LSS-XX-02-DV-XX	C-185-02-X
-03	LSS-XX-03-DV-XX	C-185-03-X

NOTES:

- ⊕ REPRESENTS A CRITICAL DIMENSION.
- BURR ALLOWANCE: .038 [.0015].
- MINIMUM PUSHOUT FORCE; TERMINALS: .5 LBS, CONTACTS: .5 LB.
- PIN 01 WILL MATE WITH CONTACT 02 ON MATING CONNECTOR.
- MEASURE FROM TOP OF VERTICAL WALL.
- MINIMUM PULL OUT FORCE FOR -LC IS .75 LB.

UNLESS OTHERWISE SPECIFIED,  
DIMENSIONS ARE IN MILLIMETERS.

TOLERANCES ARE:

DECIMALS ANGLES  
.X: ± .3 [.01] 2°  
.XX: ± .13 [.005]  
.XXX: ± .051 [.0020]

PROPRIETARY NOTE

THIS DOCUMENT CONTAINS INFORMATION  
CONFIDENTIAL AND PROPRIETARY TO  
SAMTEC, INC. AND SHALL NOT BE REPRODUCED  
OR TRANSFERRED TO OTHER DOCUMENTS OR  
DISCLOSED TO OTHERS OR USED FOR ANY  
PURPOSE OTHER THAN THAT WHICH IT WAS  
OBTAINED WITHOUT THE EXPRESSED WRITTEN  
CONSENT OF SAMTEC, INC.

MATERIAL: DO NOT SCALE DRAWING  
INSULATOR: LCP, COLOR: BLACK  
CONTACT: PHOS BRONZE

SHEET SCALE: 4:1

DESCRIPTION:  
.635mm TERMINAL/SOCKET COMBO

DWG. NO.  
LSS-1XX-XX-XX-DV-XX-XX

BY: CHAD F 07/01/2002 SHEET 1 OF 2



520 PARK EAST BLVD, NEW ALBANY, IN 47150  
PHONE: 812-944-6733 FAX: 812-948-5047  
e-Mail: info@SAMTEC.com code 55322

**FIG 2**  
-K: POLYIMIDE FILM OPTION  
(USE K-DOT-.138-.250-.005)

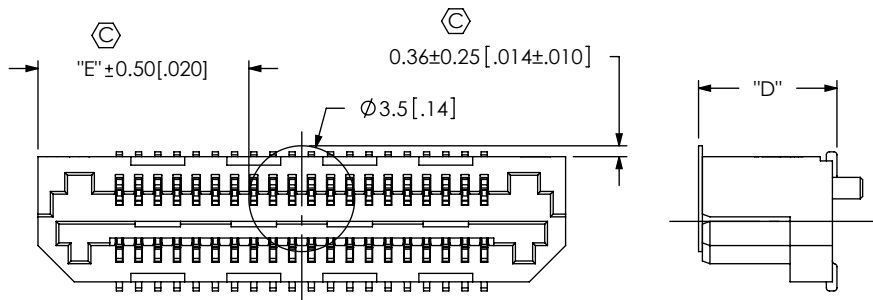

$$E = ((\text{NO OF POS} \times 0.635 [.0250]) + 4.750 [.1870]) / 2 - 1.75 [.0689]$$

TABLE 2	
BODY HT	"D"
-01	4.58 [.180]
-02	7.58 [.298]
-03	5.58 [.220]

**FIG 3**  
-LC: LOCKING CLIP OPTION  
(USE LC-08-TM-01)  
-02 & -03 LEAD STYLES ONLY  
(SEE NOTE 6, SHT. 1)

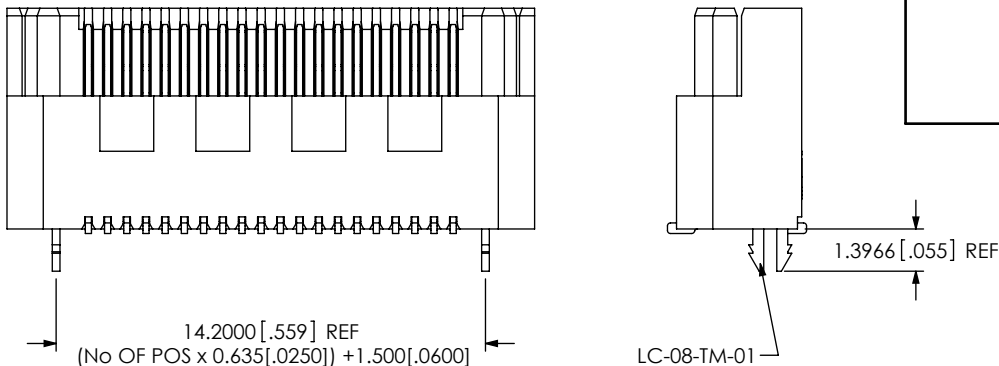

**FIG 4**

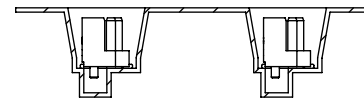
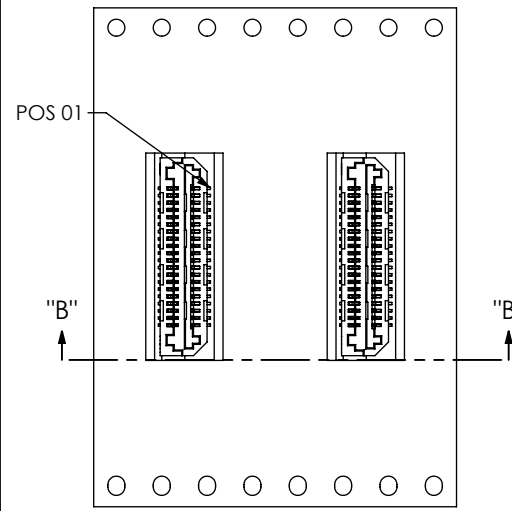

SECTION "B"- "B"  
SCALE 1.5 : 1

TAPE & REEL

LEAD STYLE	OPTION	PACKAGING TUBE	PLUG
-01	-A	PT-1-24-13-09	TP-24
-02	-A, -LC	PT-1-24-01-25	TP-03
-03	-A, -LC	PT-1-24-11-09	TP-09

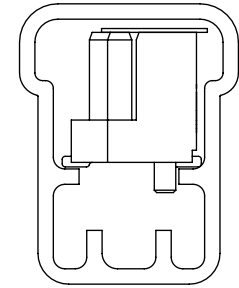

TUBE: PT-1-24-13-09  
PLUG: TP-24

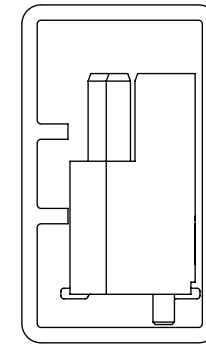

TUBE: PT-1-24-01-25  
PLUG: TP-03

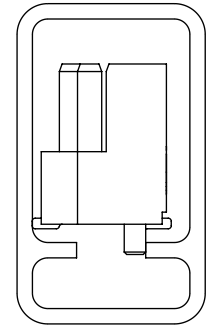

TUBE: PT-1-24-11-09  
PLUG: TP-09

LOAD PARTS WITH PIN #1 IN DIRECTION OF ARROW.

**PROPRIETARY NOTE**  
THIS DOCUMENT CONTAINS INFORMATION CONFIDENTIAL AND PROPRIETARY TO SAMTEC, INC. AND SHALL NOT BE REPRODUCED OR TRANSFERRED TO OTHER DOCUMENTS OR DISCLOSED TO OTHERS OR USED FOR ANY PURPOSE OTHER THAN THAT WHICH IT WAS OBTAINED WITHOUT THE EXPRESSED WRITTEN CONSENT OF SAMTEC, INC.

DO NOT SCALE DRAWING

SHEET SCALE: 4:1

**samtec**

520 PARK EAST BLVD, NEW ALBANY, IN 47150  
PHONE: 812-944-6733 FAX: 812-948-5047  
e-Mail: info@SAMTEC.com code 55322

DESCRIPTION:  
.635mm TERMINAL/SOCKET COMBO  
DWG. NO. **LSS-1XX-XX-XX-DV-XX-XX**

BY: CHAD F 07/01/2002 SHEET 2 OF 2