

# SERPAC 2015, DB9 for A31

Electronic Enclosures

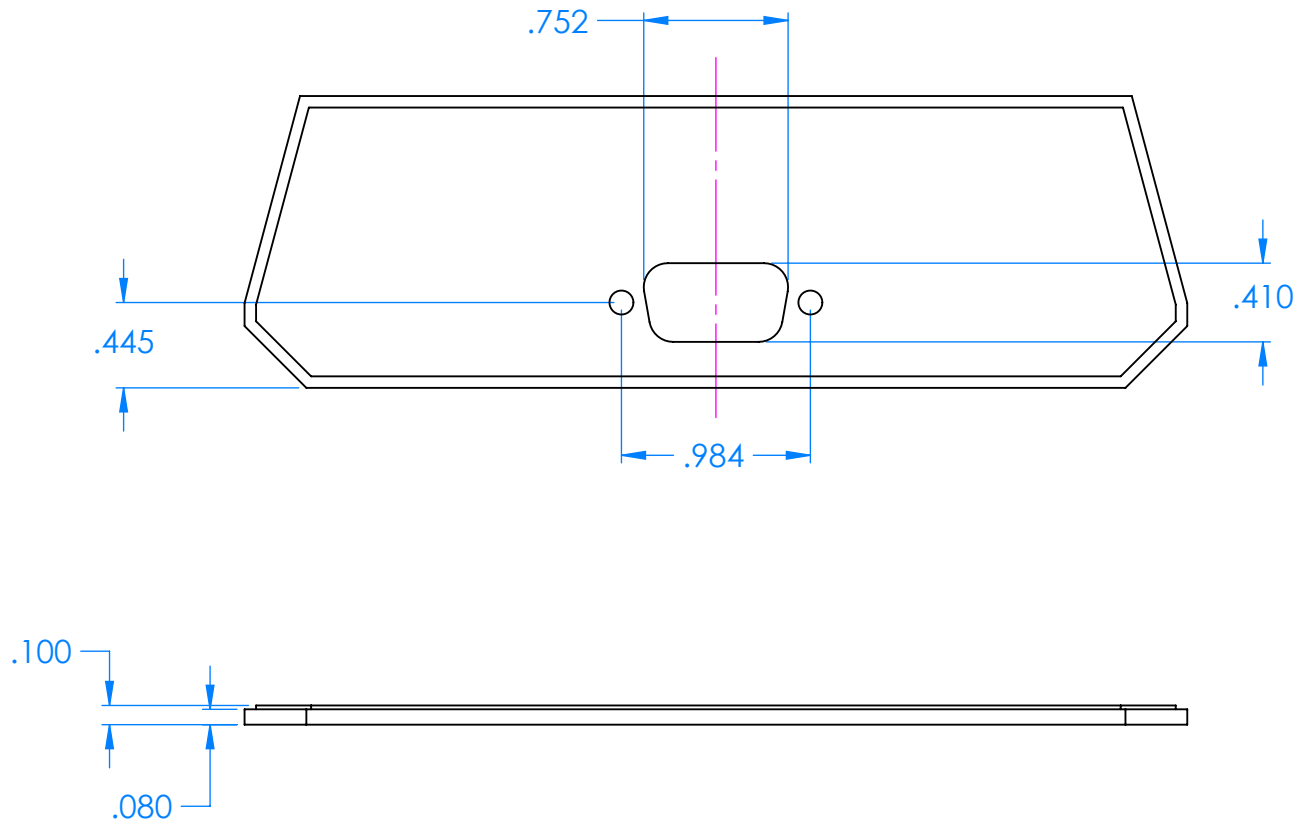

**NOTES:**

Cutout located to accept a D-sub standard surface mount DB9 connector (male or female) using a .065" thick circuit board.