

EL-29924-C36
SHT 1.1

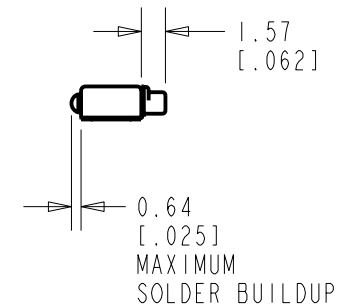
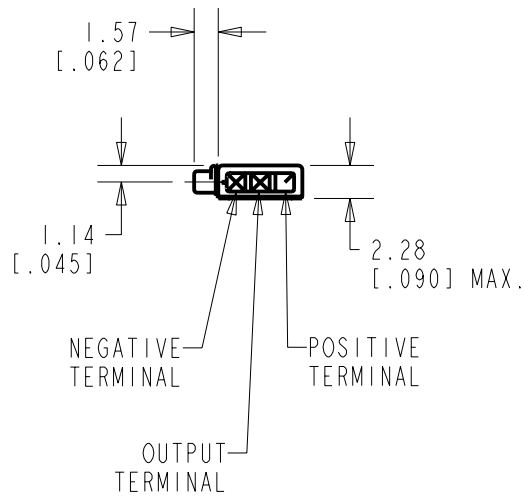
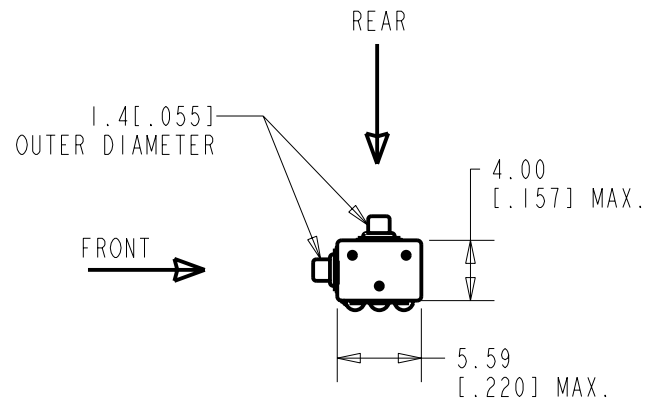

NOMINAL WEIGHT
.13 GRAM

DIMENSIONS IN MILLIMETERS [INCHES]

KNOWLES ELECTRONICS
ITASCA, ILLINOIS U.S.A.

Revision	C.O. #	Implementation Date	RELEASE LEVEL	REVISION
A	MI0100781	09/22/05	Released	A
SCALE: 2:1			DR. BY	DATE
DO NOT SCALE DRAWING			DMS	09/15/05
TITLE: MICROPHONE			CK. BY	DATE
OUTLINE DRAWING			GJP	09/26/05
EL-29924-C36			APP. BY	DATE
SHT 1.1			GJP	09/26/05

SENSITIVITY IN dB RELATIVE TO 1.0 VOLT/MICROBAR (0.1 N/m²).
UNDER THE TEST CONDITIONS SHOWN BELOW

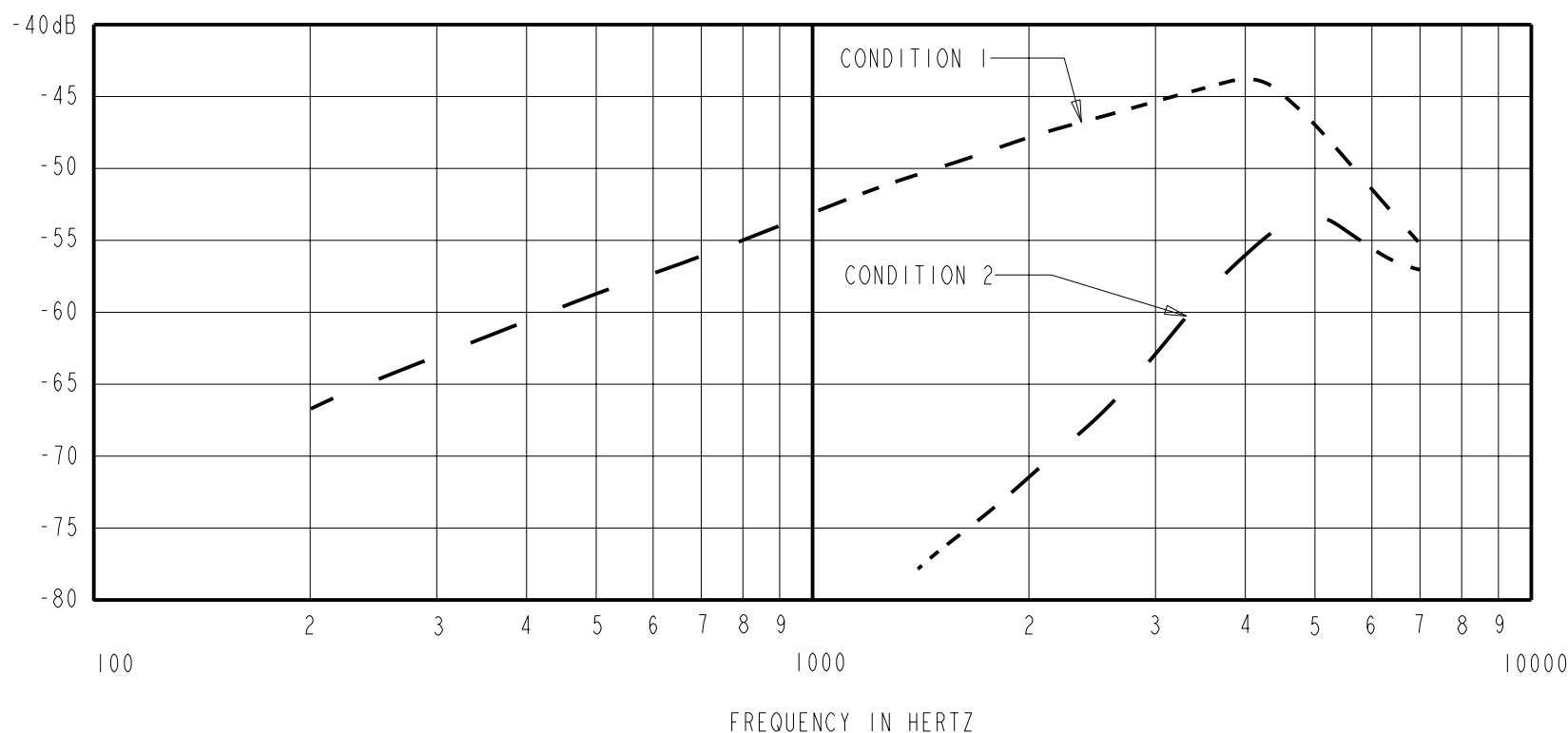

CONDITION 1 SENSITIVITY				DEVICE CONFORMITY		
FREQUENCY	MIN.	NOM.	MAX.	RANGE OF DEVIATION FROM 1 kHz		
				CONDITION 1		CONDITION 2
300	---	-63.0	---	-8.5	-11.5	---
1000	-55.0	-53.0	-51.0	0.0	0.0	-20.0 MIN.
3100-5100	---	-44.5	---	+3.5	+13.5	---

NOTES:

- MICROPHONE TO BE FUNCTIONAL WITH 10VDC SUPPLY.
- TYPICAL SENSITIVITY TO HUMIDITY AT 1000 Hz IS 0.03 dB/%RH.
- SENSITIVITY AND NOISE VALUES INDICATED ON THIS SPECIFICATION ARE VALID AT 50% HUMIDITY.
- CASE CONNECTED TO NEGATIVE TERMINAL.

DC SUPPLY	AMPLIFIER CURRENT DRAIN	SENSITIVITY CHANGE ON REDUCING SUPPLY TO 0.9VDC	"A" WEIGHTED NOISE (RE 1.0 VOLT)	OUTPUT IMPEDANCE OHMS		
				MIN.	NOM.	MAX.
1.3V	50 uA MAX	3 dB MAX.	-100.0 dB MAX.	2800	4400	6800

TEST CONDITIONS WITH TUBING AND SIGNALS DESCRIBED BELOW:
DIMENSIONS IN MILLEMMETERS [INCHES].

CAPACITANCE PROBE POINTS

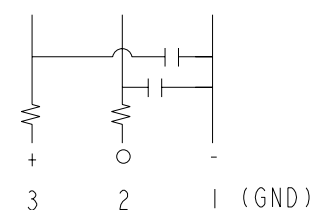
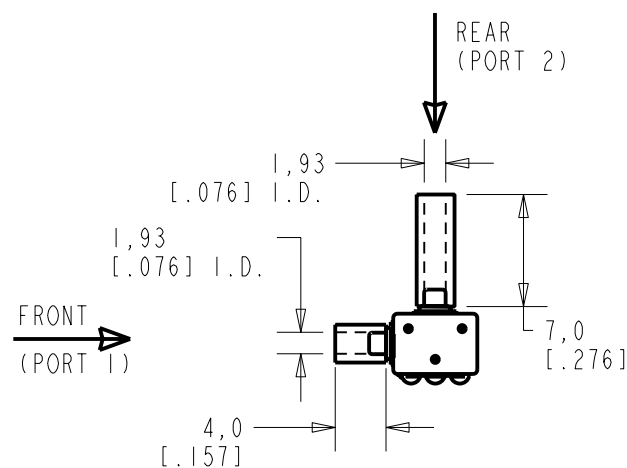

CAPACITANCE ±50%		
OUTPUT TO NEGATIVE (2-1)	OUTPUT TO POSITIVE (2-3)	POSITIVE TO NEGATIVE (3-1)
58pF	N/A	58pF

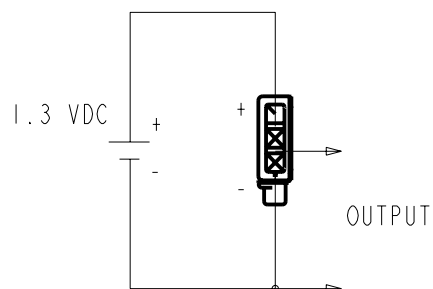

SIGNAL "A" IS A REFERENCE SIGNAL OF 1.0 MICROBAR.
SIGNAL "B" IS A PROBE SIGNAL DELAYED 56.8 MICROSECONDS WITH RESPECT TO SIGNAL "A" AND HAVING 0.981 TIMES THE AMPLITUDE.

FOR CONDITION 1

SIGNAL "A" IS APPLIED TO PORT 1
SIGNAL "B" IS APPLIED TO PORT 2

FOR CONDITION 2

SIGNAL "A" IS APPLIED TO PORT 2
SIGNAL "B" IS APPLIED TO PORT 1

Revision	C.O. #	Implementation Date	RELEASE LEVEL	REVISION
A	MI0100781	09/22/05	Released	A

KNOWLES ELECTRONICS
ITASCA, ILLINOIS U.S.A.

WHEN TEST LIMITS ARE USED TO ESTABLISH INCOMING INSPECTION ACCEPTANCE/REJECTION CRITERIA, CORRELATION OF TEST EQUIPMENT WITH KNOWLES IS ALSO REQUIRED FOR ELIMINATION OF EQUIPMENT AND TEST METHOD VARIATION

TITLE: **MICROPHONE**
PERFORMANCE SPECIFICATION

EL-29924-C36
SHT 2.1

DR. BY	DATE
DMS	09/15/05
CK. BY	DATE
GJP	09/26/05
APP. BY	DATE
GJP	09/26/05