

ED-21739-000

SHT 1.1

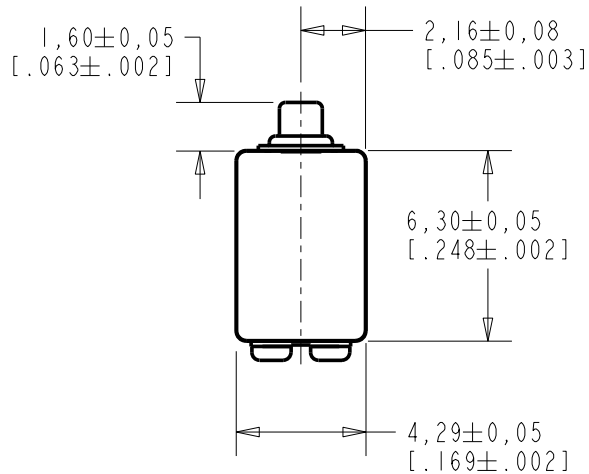

NOTE:

- 1 A POSITIVE GOING VOLTAGE AT TERMINAL 2, RELATIVE TO TERMINAL 1, CAUSES A DECREASE IN PRESSURE AT THE SOUND OUTLET.
- 2 LOCATED FROM TWO SURFACES FOR CUSTOMER CONVENIENCE. ONLY APPLICABLE FROM ONE SURFACE, NOT TO BE USED TOGETHER. HORIZONTAL LOCATION FOR TERMINAL CENTERED TO $\pm 0,17$ [.007].

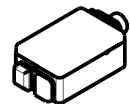
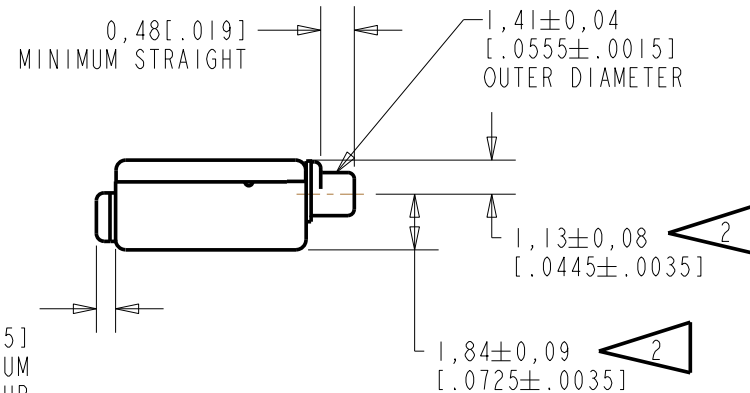
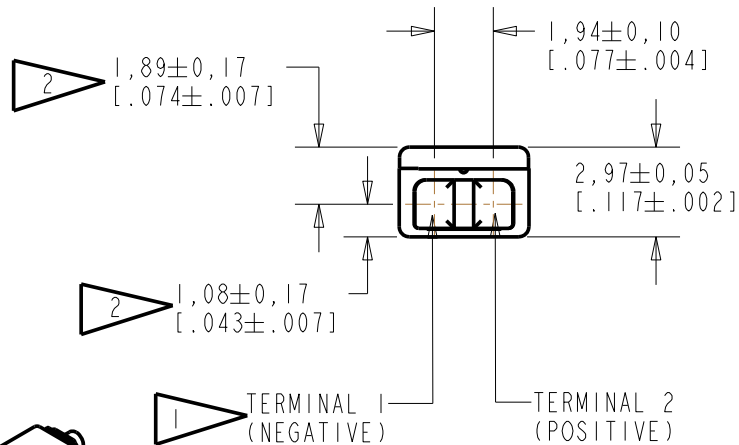

SCALE 2:1

NOMINAL WEIGHT
.31 GRAM

DIMENSIONS IN MILLIMETERS [INCHES]

Revision	C.O. #	Implementation Date	RELEASE LEVEL	REVISION
B	C10107990	7-30-08	Active	B
A	C10103544	1-4-06		

SCALE: 4:1	DR. BY: CRG	DATE: 1-4-06
DO NOT SCALE DRAWING	CK. BY: GJP	DATE: 1-5-06
TITLE: RECEIVER OUTLINE DRAWING	ED-21739-000 SHT 1.1	APP. BY: GJP DATE: 1-5-06

KNOWLES ELECTRONICS
ITASCA, ILLINOIS U.S.A.

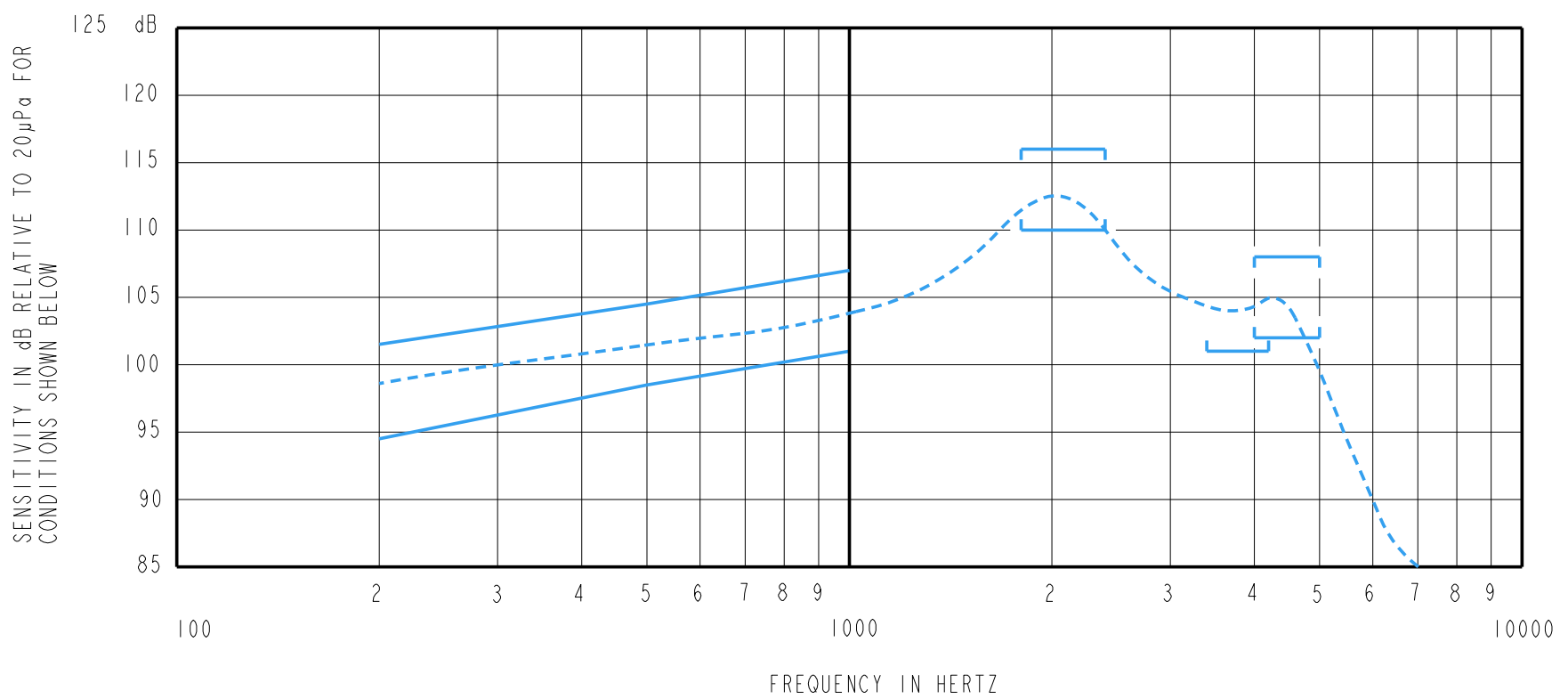

NOTES:

1. MEASUREMENTS MADE USING 10mm (.394") X 1mm (.039") ID TUBE CONNECTED TO A SIMULATED ANSI S3.7-1973 TYPE HA-3 COUPLER. (IEC 126).

2.

SENSITIVITY

FREQUENCY	MIN.	MAX.
200	94.5	101.5
500	98.5	104.5
1000	101.0	107.0
1800-2400	110.0	116.0
3400-4200	101.0	---
4000-5000	102.0	108.0

- 3. RESPONSE, IMPEDANCE, AND DISTORTION MEASUREMENTS MADE USING THE ELECTRICAL TEST CONDITIONS SHOWN BELOW.
- 4. ELECTRICAL SOURCE IMPEDANCE MUST BE GREATER THAN 20 TIMES 1KHz IMPEDANCE FOR TEST CONDITIONS SHOWN BELOW.
- 5. INDIVIDUAL SPECIFICATIONS.

PORT LOCATION	IMPEDANCE OHMS ±15%		DCR @20°C OHMS ±10%	DISTORTION		ELECTRICAL TEST CONDITIONS	
	1KHz	500Hz		MAX. %	FREQ Hz	AC mA RMS	DC mA
12C	1500	825	376	5	800	0.50	0.70

Revision	C.O. #	Implementation Date	RELEASE LEVEL	REVISION
B	C10107990	7-30-08	Active	B
A	C10103544	1-4-06		

KNOWLES ELECTRONICS
ITASCA, ILLINOIS U.S.A.

WHEN TEST LIMITS ARE USED TO ESTABLISH INCOMING INSPECTION ACCEPTANCE/REJECTION CRITERIA, CORRELATION OF TEST EQUIPMENT WITH KNOWLES IS ALSO REQUIRED FOR ELIMINATION OF EQUIPMENT AND TEST METHOD VARIATION

TITLE: **RECEIVER** ED-21739-000
PERFORMANCE SPECIFICATION **SHT 2.1**

DR. BY	DATE
CRG	1-4-06
CK. BY	DATE
GJP	1-5-06
APP. BY	DATE
GJP	1-5-06